

LEGEND

○ = Corner having information on form 7100-52 in this file.

T149N R25W 5th PM

FILING INSTRUCTION

File 7100-52 card record by letter and number coordinates behind the file guide for the township in which it falls.

File the 7100-52 card record by letter and then by number i.e., all A cards first, then B cards etc.

The first card behind the file guide (if data have been obtained and recorded) will be card A-1 for N.W. Township Corner, then card A-2 for 1/16 corner then card A-3 for 1/4 corner etc.

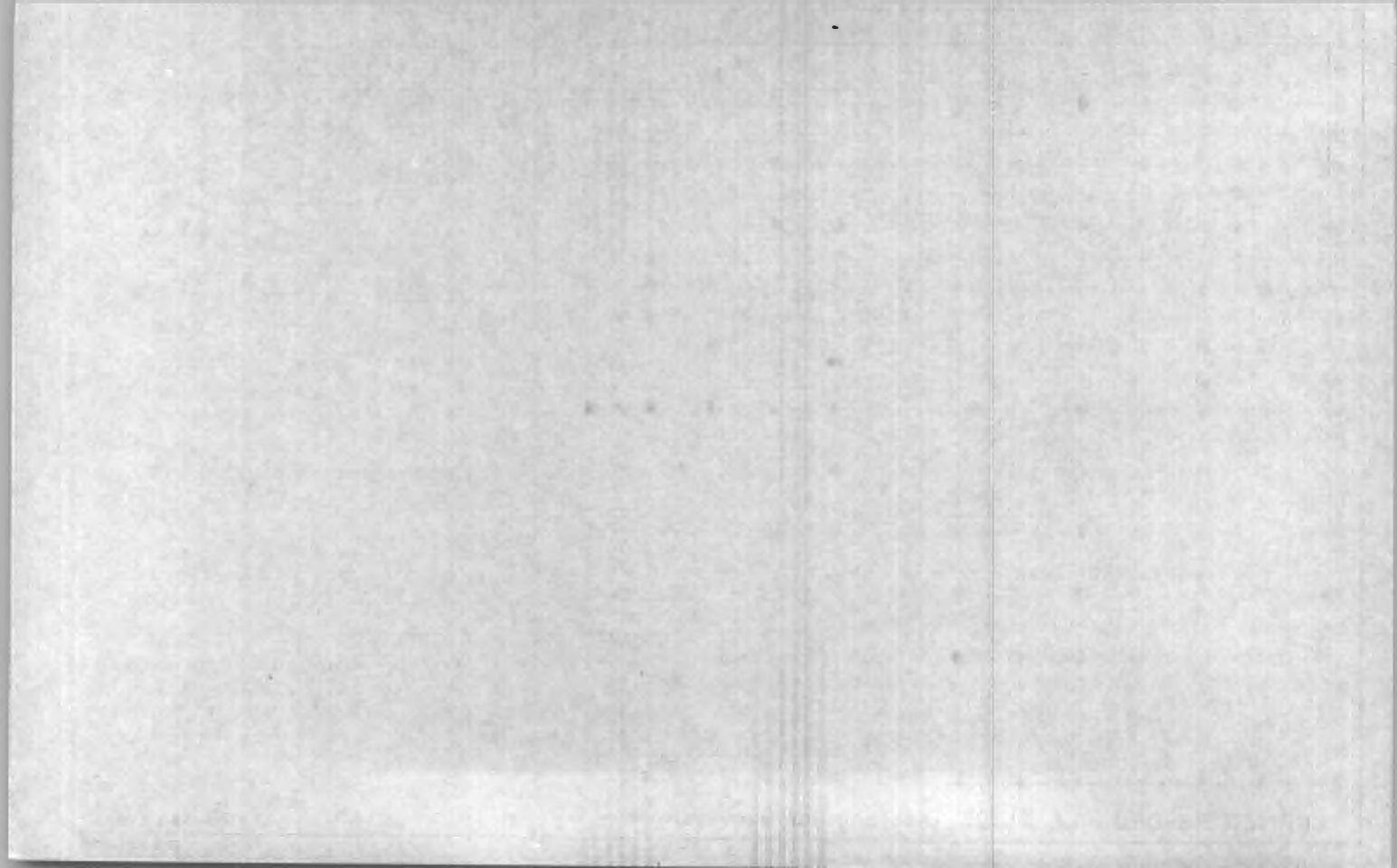

Index No. A-13
(Alphabetical - Numerical)

LAND CORNER RECORD
(RECTANGULAR SURVEYS)

R9-7150-4 (Rev. 6/13/67)
GPO 806-924

T. 149N R. 25W S. 5th Mer. N.F. Chippewa County Itasca State Minn
Corner common to sections 3, 4, 33 and 34

EXISTING SURVEYS

Original Government Survey

Year surveyed 1875
Original monument Tamarack Post
(Wood post, stone, pile of stones, pipe, etc.)

Bearing Trees

Species Tam. Spruce
Diameter 4" 8"
Bearing N 22° E S 27° W
Distance 16 lks 24 lks

Original Evidence Found

Year of search 1971 By Bevins & Martinson
Monument found None

Original Bearing Trees Found

Species None
Diameter _____
Bearing _____
Distance _____

Subsequent Corner Restoration

Year surveyed _____ By _____
Where filed or recorded _____
Monument _____
(Original, concrete post, iron rod, etc.)

Evidence of Subsequent Corner Restoration Found

Year of search _____ By _____

Bearing Trees, Reference Objects

Species _____
Diameter _____
Bearing _____
Distance _____

Bearing Trees, Reference Objects

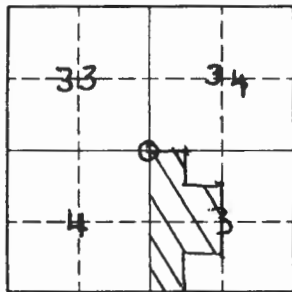

Sketch

O Corner ▨ F.S. Land

Relation of Evidence to Record Features Along Section Lines

Section line to sections _____
 Object _____
 Record distance _____
 Measured distance _____

Other Evidence

Describe evidence of use and occupation such as roads, fences, clearings, timber cutting lines, plantations, etc.. Cite source of testimony if any. _____

At time of search:

1. Did you have the record description?

Yes No _____

2. How was search area located?

Pacing, chaining, photos, maps, etc. Map, Chaining

3. Man hours spent in search 1

4. Do you think additional search might recover evidence? Yes _____ No

5. Signature _____

Perpetuation Record

Monument and accessories established. Include brief description of area. _____

Approximate Location Tag. _____

Certified corner restoration certificate prepared: Yes _____ No _____

Filed in county records at _____ Date _____ County Document No. _____

Identified on aerial photo No. _____ Which is filed at _____

Index No. B-6
(Alphabetical - Numerical)LAND CORNER RECORD
(RECTANGULAR SURVEYS)

RP-7150-4 (Rev. 6/13/67)

GPO 502-127

T. 149 R. 25
N.W. 1/16Mer. N.F. 5th Chippewa County Itasca State Minnesota
Corner common to sections 5 and _____

EXISTING SURVEYS

Original Government Survey

Year surveyed _____

Original monument _____
(Wood post, stone, pile of stones, pipe, etc.)

Bearing Trees

Species _____

Diameter _____

Bearing _____

Distance _____

Subsequent Corner Restoration

Year surveyed _____ By _____

Where filed or recorded _____

Monument _____
(Original, concrete post, iron rod, etc.)

Bearing Trees, Reference Objects

Species _____

Diameter _____

Bearing _____

Distance _____

Original Evidence Found

Year of search _____ By _____

Monument found _____

Original Bearing Trees Found

Species _____

Diameter _____

Bearing _____

Distance _____

Evidence of Subsequent Corner Restoration Found

Year of search _____ By _____

Bearing Trees, Reference Objects

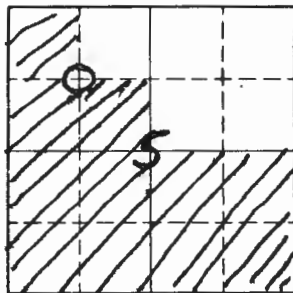

Sketch

○ Corner ▨ F.S. Land

Relation of Evidence to Record Features Along Section Lines

Section line to sections _____
 Object _____
 Record distance _____
 Measured distance _____

Other Evidence

Describe evidence of use and occupation such as roads, fences, clearings, timber cutting lines, plantations, etc.. Cite source of testimony if any.

At time of search:

1. Did you have the record description?

Yes _____ No _____

2. How was search area located?

Pacing, chaining, photos, maps, etc.

3. Man hours spent in search _____

4. Do you think additional search might recover evidence? Yes _____ No _____

5. Signature _____

Perpetuation Record

Monument and accessories established. Include brief description of area.

I put up a F.S. L.P. on the SE side of a 14" Cedar marking approx 1/16 cor and painted blue line North + East

2/77

Ronald Olson

Certified corner restoration certificate prepared: Yes _____ No _____

Filed in county records at _____ Date _____ County Document No. _____

Identified on aerial photo No. _____ Which is filed at _____

Index No. B-7
(Alphabetical - Numerical)LAND CORNER RECORD
(RECTANGULAR SURVEYS)

R9-7150-4 (Rev. 6/13/67)

GPO 802-127

T. 149 R. 25 5th Mer. N.F. Chippewa County Itasca. State Minnesota
Center North 1/16 Corner common to sections 5 and _____

EXISTING SURVEYS

Original Government Survey

Year surveyed _____

Original monument _____
(Wood post, stone, pile of stones, pipe, etc.)

Bearing Trees

Species _____

Diameter _____

Bearing _____

Distance _____

Subsequent Corner Restoration

Year surveyed _____ By _____

Where filed or recorded _____

Monument _____
(Original, concrete post, iron rod, etc.)

Bearing Trees, Reference Objects

Species _____

Diameter _____

Bearing _____

Distance _____

Original Evidence Found

Year of search _____ By _____

Monument found _____

Original Bearing Trees Found

Species _____

Diameter _____

Bearing _____

Distance _____

Evidence of Subsequent Corner Restoration Found

Year of search _____ By _____

Bearing Trees, Reference Objects

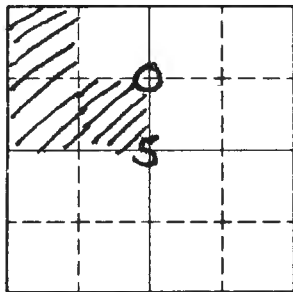

Sketch

○ Corner ▨ F.S. Land

Relation of Evidence to Record Features Along Section Lines

Section line to sections _____
 Object _____
 Record distance _____
 Measured distance _____

Other Evidence

Describe evidence of use and occupation such as roads, fences, clearings, timber cutting lines, plantations, etc.. Cite source of testimony if any.

At time of search:

1. Did you have the record description?

Yes _____ No _____

2. How was search area located?

Pacing, chaining, photos, maps,
 etc. _____

3. Man hours spent in search _____

4. Do you think additional search might
 recover evidence? Yes _____ No _____

5. Signature _____

Perpetuation Record

Monument and accessories, established. Include brief description of area.

*I put up a F.S.L.P. on the North Side of a
 9" Balsam marking approx 1/16 cor. and
 painted blue line West.*

2/77 Ronald Olson

Certified corner restoration certificate prepared: Yes _____ No _____

Filed in county records at _____ Date _____ County Document No. _____

Identified on aerial photo No. _____ Which is filed at _____

Index No. C-4
(Alphabetical - Numerical)

LAND CORNER RECORD
(RECTANGULAR SURVEYS)

RP-7150-4 (Rev. 6/13/67)
 GPO 802-127

T. 149 R. 25 Mer. N.F. 574 Chippewa County Itasca State Minnesota
E 116 Corner common to sections 6 and _____

EXISTING SURVEYS

Original Government Survey	Original Evidence Found
Year surveyed _____	Year of search _____ By _____
Original monument _____ <small>(Wood post, stone, pile of stones, pipe, etc.)</small>	Monument found _____
Bearing Trees	Original Bearing Trees Found
Species _____	Species _____
Diameter _____	Diameter _____
Bearing _____	Bearing _____
Distance _____	Distance _____
Subsequent Corner Restoration	Evidence of Subsequent Corner Restoration Found
Year surveyed _____ By _____	Year of search _____ By _____
Where filed or recorded _____	_____
Monument _____ <small>(Original, concrete post, iron rod, etc.)</small>	_____
_____	_____
Bearing Trees, Reference Objects	Bearing Trees, Reference Objects
Species _____	_____
Diameter _____	_____
Bearing _____	_____
Distance _____	_____

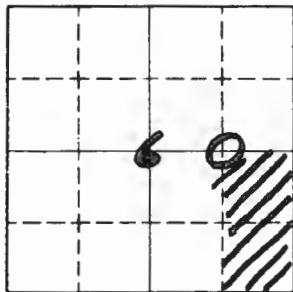

Sketch

○ Corner ▨ F.S. Land

Relation of Evidence to Record Features Along Section Lines

Section line to sections _____
 Object _____
 Record distance _____
 Measured distance _____

Other Evidence

Describe evidence of use and occupation such as roads, fences, clearings, timber cutting lines, plantations, etc.. Cite source of testimony if any.

At time of search:

1. Did you have the record description?

Yes _____ No _____

2. How was search area located?

Pacing, chaining, photos, maps,
 etc. _____

3. Man hours spent in search _____

4. Do you think additional search might

recover evidence? Yes _____ No _____

5. Signature _____

Perpetuation Record

Monument and accessories established. Include brief description of area.

*I put up F.S.L.P on the South side of
 a 5" Balsam marking APPROX 1/16 cor
 painted blue line South of cor.*

2/97

Ronald O'Leary

Certified corner restoration certificate prepared: Yes _____ No _____

Filed in county records at _____ Date _____ County Document No. _____

Identified on aerial photo No. _____ Which is filed at _____

Index No. C-9
(Alphabetical-Numerical)LAND CORNER RECORD
(RECTANGULAR SURVEYS)R9-7150-4 (Rev. 6/13/67)
GPO 802-127T. 149 R. 25 5th Mer. N.F. Chippewa County Itasca State Minnesota
114 Corner common to sections 4 5

EXISTING SURVEYS

Original Government Survey

Year surveyed 1875
Original monument POST
(Wood post, stone, pile of stones, pipe, etc.)

Bearing Trees

Species Tamr Tam
Diameter 6" 4"
Bearing S34°W N2°W
Distance 20 1/2 7 1/2

Subsequent Corner Restoration

Year surveyed _____ By _____
Where filed or recorded _____
Monument _____
(Original, concrete post, iron rod, etc.)

Bearing Trees, Reference Objects

Species _____
Diameter _____
Bearing _____
Distance _____

Original Evidence Found

Year of search 1977 By R. Olson
Monument found None

Original Bearing Trees Found

Species _____
Diameter None
Bearing _____
Distance _____

Evidence of Subsequent Corner Restoration Found

Year of search _____ By _____

Bearing Trees, Reference Objects

Species _____
Diameter _____
Bearing _____
Distance _____

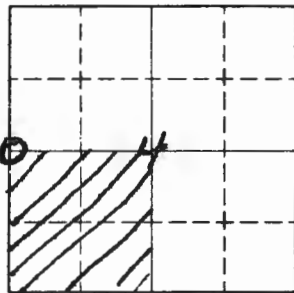

Sketch

○ Corner ▨ F.S. Land

Relation of Evidence to Record Features Along Section Lines

Section line to sections _____
 Object _____
 Record distance _____
 Measured distance _____

Other Evidence

Describe evidence of use and occupation such as roads, fences, clearings, timber cutting lines, plantations, etc.. Cite source of testimony if any.

At time of search:

1. Did you have the record description?

Yes No _____

2. How was search area located?

Pacing, chaining, photos, maps,
 etc. Chain & Compass

3. Man hours spent in search 2

4. Do you think additional search might
 recover evidence? Yes _____ No

5. Signature Ronald Olson

Perpetuation Record

Monument and accessories established. Include brief description of area.

I put up a F.S. L.P. on the W. Side of a
 12" Hspn marking Approx 1/4 Cor. &
 painted blue line East.

2/77 Ronald Olson

Certified corner restoration certificate prepared: Yes _____ No _____

Filed in county records at _____ Date _____ County Document No. _____

Identified on aerial photo No. _____ Which is filed at _____

Index No. C-13
(Alphabetical-Numerical)LAND CORNER RECORD
(RECTANGULAR SURVEYS)R9-7150-4 (Rev. 6/13/67)
GPO 806-924T. 119N R. 25W 5th Mer. N.F. Chippewa County Itasca State Minn.
1/4 Corner common to sections 3 and 4

EXISTING SURVEYS

Original Government Survey

Year surveyed 1875
Original monument Cedar Post
(Wood post, stone, pile of stones, pipe, etc.)

Bearing Trees

Species W. Birch Cedar
Diameter 10 9
Bearing S61° E W
Distance 27 lks 15 lks

Subsequent Corner Restoration

Year surveyed _____ By _____
Where filed or recorded _____
Monument _____
(Original, concrete post, iron rod, etc.)

Bearing Trees, Reference Objects

Species _____
Diameter _____
Bearing _____
Distance _____

Original Evidence Found

Year of search 1971 By Bevins & Martinson
Monument found None

Original Bearing Trees Found

Species None
Diameter _____
Bearing _____
Distance _____

Evidence of Subsequent Corner Restoration Found

Year of search _____ By _____

Bearing Trees, Reference Objects

Species _____
Diameter _____
Bearing _____
Distance _____

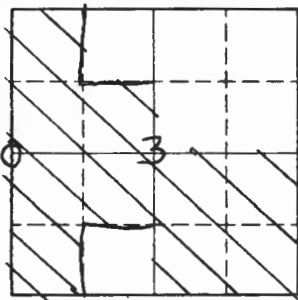

Sketch

○ Corner ▨ F.S. Land

Relation of Evidence to Record Features Along Section Lines

Section line to sections _____
Object _____
Record distance _____
Measured distance _____

Other Evidence

Describe evidence of use and occupation such as roads, fences, clearings, timber cutting lines, plantations, etc.. Cite source of testimony if any. _____

At time of search:

1. Did you have the record description?

Yes No _____

2. How was search area located?

Pacing, chaining, photos, maps,
etc. Compass, chaining

3. Man hours spent in search 2

4. Do you think additional search might
recover evidence? Yes No _____

5. Signature _____

Perpetuation Record

Monument and accessories established. Include brief description of area. _____

LOCATION TAG

Certified corner restoration certificate prepared: Yes _____ No _____

Filed in county records at _____ Date _____ County Document No. _____

Identified on aerial photo No. _____ Which is filed at _____

Index No. D-11
(Alphabetical - Numerical)

LAND CORNER RECORD
(RECTANGULAR SURVEYS)

RD-7150-4 (Rev. 6/13/67)
GPO 802-127

T. 149 R. 25 6th Mer. N.F. Chippewa County Itasca State Minnesota
Center South 1/16 Corner common to sections 4 and _____

EXISTING SURVEYS

Original Government Survey

Year surveyed _____

Original monument _____
(Wood post, stone, pile of stones, pipe, etc.)

Bearing Trees

Species _____

Diameter _____

Bearing _____

Distance _____

Original Evidence Found

Year of search _____ By _____

Monument found _____

Original Bearing Trees Found

Species _____

Diameter _____

Bearing _____

Distance _____

Subsequent Corner Restoration

Year surveyed _____ By _____

Where filed or recorded _____

Monument _____
(Original, concrete post, iron rod, etc.)

Bearing Trees, Reference Objects

Species _____

Diameter _____

Bearing _____

Distance _____

Evidence of Subsequent Corner Restoration Found

Year of search _____ By _____

Bearing Trees, Reference Objects

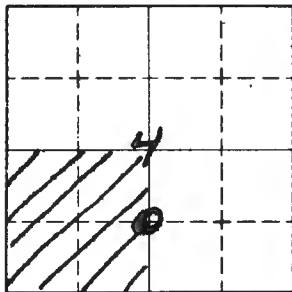

Sketch

○ Corner ▨ F.S. Land

Relation of Evidence to Record Features Along Section Lines

Section line to sections _____
 Object _____
 Record distance _____
 Measured distance _____

Other Evidence

Describe evidence of use and occupation such as roads, fences, clearings, timber cutting lines, plantations, etc. Cite source of testimony if any.

Old blazes running North + South

At time of search:

1. Did you have the record description?

Yes _____ No _____

2. How was search area located?

Pacing, chaining, photos, maps, etc. _____

3. Man hours spent in search _____

4. Do you think additional search might recover evidence? Yes _____ No _____

5. Signature _____

Perpetuation Record

Monument and accessories established. Include brief description of area.

I put up a F.S. L.P. on the West side of a 6" Cedar marking approx 1/16 cor. and painted blue line south of cor

2/77 Ronald Olson

Certified corner restoration certificate prepared: Yes _____ No _____

Filed in county records at _____ Date _____ County Document No. _____

Identified on aerial photo No. _____ Which is filed at _____

E-1 / E-25
Index No. (Alphabetical - Numerical)

LAND CORNER RECORD
(RECTANGULAR SURVEYS)

RD-7150-4 (Rev. 6/13/67)
GPO 502-127

T. 149 R. 26/25 Sth Mer. N.F. Chippewa County Itasca State MN
Section Corner common to sections 1, 12, 6 and 7

EXISTING SURVEYS

Original Government Survey

Year surveyed Oct-Nov 1875
Original monument 4x5 Tam. Post
(Wood post, stone, pile of stones, pipe, etc.)

Species	Bearing Trees			
	Tam	Tam	Tam	Tam
Diameter	<u>7</u>	<u>7</u>	<u>6</u>	<u>8</u>
Bearing	<u>S27W</u>	<u>N19W</u>	<u>N12E</u>	<u>S45E</u>
Distance	<u>19.8'</u>	<u>22.44'</u>	<u>17.16'</u>	<u>32.34'</u>

Subsequent Corner Restoration

Year surveyed _____ By _____
Where filed or recorded _____
Monument _____
(Original, concrete post, iron rod, etc.)

Bearing Trees, Reference Objects

Species _____
Diameter _____
Bearing _____
Distance _____

Original Evidence Found

Year of search 1982 By Whitchorn, Oleson, Krause
Monument found NONE

Original Bearing Trees Found

Species	_____	_____	_____	<u>Stump</u>
Diameter	_____	_____	_____	<u>Rotten</u>
Bearing	_____	_____	_____	<u>S45°E</u>
Distance	_____	_____	_____	<u>32.34'</u>

Scribe Vis.

Evidence of Subsequent Corner Restoration Found

Year of search _____ By _____

Bearing Trees, Reference Objects

Species _____
Diameter _____
Bearing _____
Distance _____

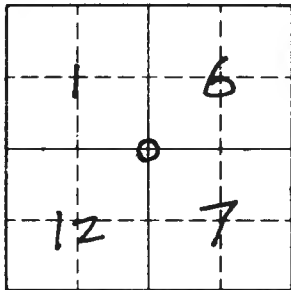

Sketch

○ Corner ▨ F.S. Land

Relation of Evidence to Record Features Along Section Lines

Section line to sections	<u>1 & 6</u>	<u>6 & 7</u>
Object	<u>Fletcher Cr.</u>	<u>Fletcher Cr.</u>
Record distance	<u>132'</u>	<u>444 455.4' to NE Shore</u>
Measured distance	<u>150'</u>	<u>200' to SW Shore</u>

Other Evidence

Describe evidence of use and occupation such as roads, fences, clearings, timber cutting lines, plantations, etc.. Cite source of testimony if any.

See Book 2 of Corner Restoration
Page 11

At time of search:

1. Did you have the record description?

Yes No

2. How was search area located?

Pacing, chaining, photos, maps,
etc. chaining photos
maps

3. Man hours spent in search 2

4. Do you think additional search might recover evidence? Yes No

5. Signature WHITE HORN 19677

Perpetuation Record

Monument and accessories established. Include brief description of area.

See Book #3, Page 2

Certified corner restoration certificate prepared: Yes No

Filed in county records at _____ Date _____ County Document No. _____

Identified on aerial photo No. _____ Which is filed at _____

Index No. E-1
(Alphabetical - Numerical)

LAND CORNER RECORD
(RECTANGULAR SURVEYS)

RS-5680-11 (5/12/64)

T. 149N R. 25-26W 5th Mer. N.F. Chippewa County Itasca State Minn.
Section Corner common to sections 6, 7, 1 and 12

EXISTING SURVEYS

Original Government Survey

Year surveyed 1875
Original monument Wood Post
(Wood post, stone, pile of stones, pipe, etc.)

Bearing Trees			
Species <u>Tam.</u>	<u>Tam.</u>	<u>Tam.</u>	<u>Tam.</u>
Diameter <u>7"</u>	<u>7"</u>	<u>6"</u>	<u>8"</u>
Bearing <u>S27°W</u>	<u>N19°W</u>	<u>N12°E</u>	<u>S45°E</u>
Distance <u>19.8'</u>	<u>22.44'</u>	<u>17.16'</u>	<u>32.34'</u>

Original Evidence Found

Year of search 1968 By R.H. McDonald
Monument found None

Original Bearing Trees Found

Species _____
Diameter _____
Bearing _____
Distance _____

Subsequent Corner Restoration

Year surveyed _____ By _____
Where filed or recorded _____
Monument _____
(Original, concrete post, iron rod, etc.)

Evidence of Subsequent Corner Restoration Found

Year of search _____ By _____

Bearing Trees, Reference Objects

Species _____
Diameter _____
Bearing _____
Distance _____

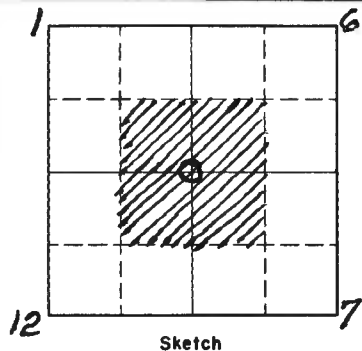

Sketch

○ Corner ▨ F.S. Land

Relation of Evidence to Record Features Along Section Lines

Section line to sections 7-6
 Object Creek
 Record distance North 132'
 Measured distance _____

Other Evidence

Describe evidence of use and occupation such as roads, fences, clearings, timber cutting lines, plantations, etc. Cite source of testimony if any. Corner Falls in an old road - BT's were probably destroyed in road construction.

At time of search:

1. Did you have the record description?

Yes No _____

2. How was search area located?

Pacing, chaining, photos, maps, etc. Photos

3. Man hours spent in search 3

4. Do you think additional search might recover evidence? Yes _____ No

Perpetuation Record

Monument and accessories established. Include brief description of area. _____

Certified corner restoration certificate prepared: Yes _____ No _____

Filed in county records at _____ Date _____ County Document No. _____

Identified on aerial photo No. _____ Which is filed at _____

5. Signature

W. M. D. Field

T. 149N R. 25W Mer. N.F. Chippewa County Itasca State MINN.
Quarter Corner common to sections 6 and 7

EXISTING SURVEYS

Original Government Survey

Year surveyed 1875
 Original monument Wood Post
(Wood post, stone, pile of stones, pipe, etc.)

Bearing Trees

Species Black Pine
 Diameter 10"
 Bearing S 6° W
 Distance 138.6'

Original Evidence Found

Year of search 1969 By R.H. McDonald
 Monument found None

Original Bearing Trees Found

Species _____
 Diameter _____
 Bearing _____
 Distance _____

Subsequent Corner Restoration

Year surveyed _____ By _____
 Where filed or recorded _____
 Monument _____
(Original, concrete post, iron rod, etc.)

Bearing Trees, Reference Objects

Species _____
 Diameter _____
 Bearing _____
 Distance _____

Evidence of Subsequent Corner Restoration Found

Year of search _____ By _____

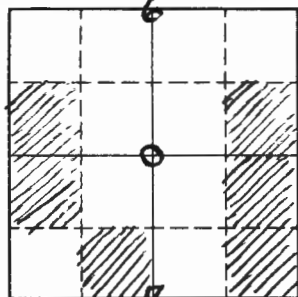

Sketch

○ Corner ▨ F.S. Land

Relation of Evidence to Record Features Along Section Lines

Section line to sections _____
 Object _____
 Record distance _____
 Measured distance _____

Other Evidence

Describe evidence of use and occupation such as roads, fences, clearings, timber cutting lines, plantations, etc.. Cite source of testimony if any. Point for corner should be near an old fence line (in a meadow)
There are pine stumps on south side of meadow but all are badly burned.

At time of search:

1. Did you have the record description?

Yes No _____

2. How was search area located?

Pacing, chaining, photos, maps, etc. Photo - Map

3. Man hours spent in search 2

4. Do you think additional search might recover evidence? Yes _____ No

Perpetuation Record

Monument and accessories established. Include brief description of area. _____

Certified corner restoration certificate prepared: Yes _____ No _____

Filed in county records at _____ Date _____ County Document No. _____

Identified on aerial photo No. _____ Which is filed at _____

5. Signature W. M. Donald

Index No. E-4
(Alphabetical - Numerical)

LAND CORNER RECORD
(RECTANGULAR SURVEYS)

R9-7150-4 (Rev. 6/13/67)
GPO 802-127

T. 149 R. 25 5th Mer. N.F. Chippewa County Itasca State Minnesota
E 1/16 Corner common to sections 6 7

EXISTING SURVEYS

Original Government Survey

Year surveyed _____

Original monument _____
(Wood post, stone, pile of stones, pipe, etc.)

Bearing Trees

Species _____

Diameter _____

Bearing _____

Distance _____

Original Evidence Found

Year of search _____ By _____

Monument found _____

Original Bearing Trees Found

Species _____

Diameter _____

Bearing _____

Distance _____

Subsequent Corner Restoration

Year surveyed _____ By _____

Where filed or recorded _____

Monument _____
(Original, concrete post, iron rod, etc.)

Evidence of Subsequent Corner Restoration Found

Year of search _____ By _____

Bearing Trees, Reference Objects

Species _____

Diameter _____

Bearing _____

Distance _____

Bearing Trees, Reference Objects

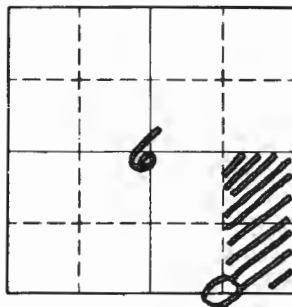

Sketch

○ Corner ▨ F.S. Land

Relation of Evidence to Record Features Along Section Lines

Section line to sections _____
 Object _____
 Record distance _____
 Measured distance _____

Other Evidence

Describe evidence of use and occupation such as roads, fences, clearings, timber cutting lines, plantations, etc.. Cite source of testimony if any.

At time of search:

1. Did you have the record description?

Yes _____ No _____

2. How was search area located?

Pacing, chaining, photos, maps,
 etc. _____

3. Man hours spent in search _____

4. Do you think additional search might
 recover evidence? Yes _____ No _____

5. Signature _____

Perpetuation Record

Monument and accessories established. Include brief description of area.

*I put up a F.S.L.P. on South side of a
 3" Aspen marking approx. 1/16 cot.
 painted blue with North of cor*

2/77 Ronald Olson

Certified corner restoration certificate prepared: Yes _____ No _____

Filed in county records at _____ Date _____ County Document No. _____

Identified on aerial photo No. _____ Which is filed at _____

Index No. E-7
(Alphabetical - Numerical)

LAND CORNER RECORD
(RECTANGULAR SURVEYS)

R9-7150-4 (Rev. 6/13/67)
 GPO 802-127

T. 149 R. 25 5th Mer. N.F. Chippewa County Itasca State Minnesota
1/4 Corner common to sections 5, 8, and _____

EXISTING SURVEYS

Original Government Survey

Year surveyed 1875
 Original monument wood post
(Wood post, stone, pile of stones, pipe, etc.)

Bearing Trees

Species Cedar Tam
 Diameter 6" 10"
 Bearing South N13°W
 Distance 6.6' 13.86'

Subsequent Corner Restoration

Year surveyed _____ By _____
 Where filed or recorded _____
 Monument _____
(Original, concrete post, iron rod, etc.)

Bearing Trees, Reference Objects

Species _____
 Diameter _____
 Bearing _____
 Distance _____

Original Evidence Found

Year of search 1977 By R. Olson
 Monument found None

Original Bearing Trees Found

Species _____
 Diameter _____
 Bearing None
 Distance _____

Evidence of Subsequent Corner Restoration Found

Year of search _____ By _____

Bearing Trees, Reference Objects

Species _____
 Diameter _____
 Bearing _____
 Distance _____

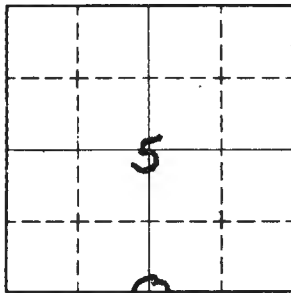

Sketch

○ Corner ▨ F.S. Land

Relation of Evidence to Record Features Along Section Lines

Section line to sections _____
 Object _____
 Record distance _____
 Measured distance _____

Other Evidence

Describe evidence of use and occupation such as roads, fences, clearings, timber cutting lines, plantations, etc.. Cite source of testimony if any.

At time of search:

1. Did you have the record description?

Yes _____ No _____

2. How was search area located?

Pacing, chaining, photos, maps, etc.

3. Man hours spent in search _____

4. Do you think additional search might recover evidence? Yes _____ No _____

5. Signature _____

Perpetuation Record

Monument and accessories established. Include brief description of area.
I put up a F.S.L.P. on the North side of a 4" Hesper marking approx 1/4 cor. & painted blue line East. I chained into area from South & East

2/77

Ronald Olson

Certified corner restoration certificate prepared: Yes _____ No _____

Filed in county records at _____ Date _____ County Document No. _____

Identified on aerial photo No. _____ Which is filed at _____

Index No. E-11
(Alphabetical-Numerical)LAND CORNER RECORD
(RECTANGULAR SURVEYS)

R9-7150-4 (Rev. 6/13/67)

GPO 502-127

T. 149 R. 25 5th Mer. N.F. Chippewa County Itasca State Minnesota
1/4 Corner common to sections 4, 9, and _____

EXISTING SURVEYS

Original Government Survey

Year surveyed 1875
Original monument Post
(Wood post, stone, pile of stones, pipe, etc.)

Bearing Trees

Species Flr W. Pine
Diameter 5" 15"
Bearing N53W S73°E
Distance 251ks 151ks

Subsequent Corner Restoration

Year surveyed _____ By _____
Where filed or recorded _____
Monument _____
(Original, concrete post, iron rod, etc.)

Bearing Trees, Reference Objects

Species _____
Diameter _____
Bearing _____
Distance _____

Original Evidence Found

Year of search 1977 By R. Oleson
Monument found None

Original Bearing Trees Found

Species _____
Diameter _____
Bearing None
Distance _____

Evidence of Subsequent Corner Restoration Found

Year of search _____ By _____

Bearing Trees, Reference Objects

Species _____
Diameter _____
Bearing _____
Distance _____

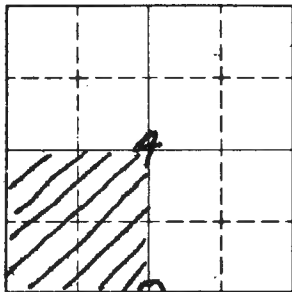

Sketch

O Corner ▨ F.S. Land

Relation of Evidence to Record Features Along Section Lines

Section line to sections _____
 Object _____
 Record distance _____
 Measured distance _____

Other Evidence

Describe evidence of use and occupation such as roads, fences, clearings, timber cutting lines, plantations, etc.. Cite source of testimony if any. *blazed line running North from cor*

At time of search:

1. Did you have the record description?
 Yes No _____

2. How was search area located?

Pacing chaining photos, maps, etc. Compass

3. Man hours spent in search 3

4. Do you think additional search might recover evidence? Yes _____ No _____
 ?

5. Signature Ronald Olsen

Perpetuation Record

Monument and accessories established. Include brief description of area.

I put up a F.S. L.P. on the south side of 8" spruce marking approx cor. and painted blue line North. I chained to this point from the approx S-E cor 4, 5, 33 + 32 South & East.

2/77

Certified corner restoration certificate prepared: Yes _____ No _____

Filed in county records at _____ Date _____ County Document No. _____

Identified on aerial photo No. _____ Which is filed at _____

Index No. E-13
(Alphabetical - Numerical)

LAND CORNER RECORD
(RECTANGULAR SURVEYS)

R9-7 150-4 (Rev. 6/13/67)
GPO 802-127

T. 149 N R. 25 W 5th Mer. N.F. Chippewa County Itasca State Minnesota
Sec Corner common to sections 3, 4, 9 and 10

EXISTING SURVEYS

Original Government Survey

Year surveyed 1875
Original monument Wood Post
(Wood post, stone, pile of stones, pipe, etc.)

Bearing Trees

Species Tam Dadspr Dead Spr.
Diameter 6 8 10
Bearing N 27 W N 21 E S 60 W
Distance 24 50 29

Subsequent Corner Restoration

Year surveyed _____ By _____
Where filed or recorded _____
Monument _____
(Original, concrete post, iron rod, etc.)

Bearing Trees, Reference Objects

Species _____
Diameter _____
Bearing _____
Distance _____

Original Evidence Found

Year of search _____ By _____
Monument found _____

Original Bearing Trees Found

Species None
Diameter _____
Bearing _____
Distance _____

Evidence of Subsequent Corner Restoration Found

Year of search _____ By _____

Bearing Trees, Reference Objects

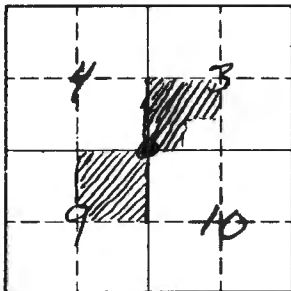

Sketch

○ Corner ▨ F.S. Land

Relation of Evidence to Record Features Along Section Lines

Section line to sections _____
 Object _____
 Record distance _____
 Measured distance _____

Other Evidence

Describe evidence of use and occupation such as roads, fences, clearings, timber cutting lines, plantations, etc.. Cite source of testimony if any. _____

At time of search:

1. Did you have the record description?

Yes No _____

2. How was search area located?

Pacing chaining, photos maps, etc. _____

3. Man hours spent in search 2

4. Do you think additional search might recover evidence? Yes _____ No _____

5. Signature Ronald D. Olson

Perpetuation Record

Monument and accessories established. Include brief description of area.

Placed a F.S. location on the SW side of 18" Blm of dilted which had old blazes on 4 sides Marking Approx cor.

Certified corner restoration certificate prepared: Yes _____ No _____

Filed in county records at _____ Date _____ County Document No. _____

Identified on aerial photo No. _____ Which is filed at _____

Index No. E-19
(Alphabetical - Numerical)

LAND CORNER RECORD
(RECTANGULAR SURVEYS)

R9-7150-4 (Rev. 6/13/67)
GPO 806-924

T. 149 N R. 25 W Mer. N.F. Chippewa County Itasca State Minn.
Quarter Corner common to sections 2 11 and _____

EXISTING SURVEYS

Original Government Survey

Year surveyed 1875
Original monument wood post
(wood post, stone, pile of stones, pipe, etc.)

Bearing Trees

Species Spruce Tamarack
Diameter 4" 15"
Bearing S70°W N84°E
Distance 33.0' 132.0'

Subsequent Corner Restoration

Year surveyed _____ By _____
Where filed or recorded _____
Monument _____
(Original, concrete post, iron rod, etc.)

Bearing Trees, Reference Objects

Species _____
Diameter _____
Bearing _____
Distance _____

Original Evidence Found

Year of search 1967 By RH McDonald
Monument found _____

Original Bearing Trees Found

Species _____
Diameter _____
Bearing _____
Distance _____

Evidence of Subsequent Corner Restoration Found

Year of search _____ By _____

Bearing Trees, Reference Objects

Species _____
Diameter _____
Bearing _____
Distance _____

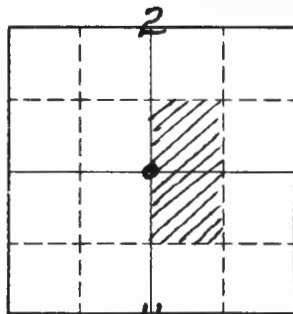

Sketch

○ Corner ▨ F.S. Land

Relation of Evidence to Record Features Along Section Lines

Section line to sections _____
 Object _____
 Record distance _____
 Measured distance _____

Other Evidence

Describe evidence of use and occupation such as roads, fences, clearings, timber cutting lines, plantations, etc.. Cite source of testimony if any. _____

Perpetuation Record

Monument and accessories established. Include brief description of area. _____

Certified corner restoration certificate prepared: Yes _____ No _____

Filed in county records at _____ Date _____ County Document No. _____

Identified on aerial photo No. _____ Which is filed at _____

At time of search:

1. Did you have the record description?

Yes No _____

2. How was search area located?

Pacing, chaining, photos, maps,
 etc. _____

3. Man hours spent in search 3

4. Do you think additional search might
 recover evidence? Yes _____ No

5. Signature Robert A. McDonald

Index No. E-21
(Alphabetical-Numerical)

LAND CORNER RECORD
(RECTANGULAR SURVEYS)

R9-7150-4 (Rev. 6/13/67)
 GPO 806-924

T. 149 N R. 25 W 5th Mer. N.F. Chippewa County Itasca State MINN.
Section Corner common to sections 1, 2, 11 and 12

EXISTING SURVEYS

Original Government Survey

Year surveyed 1875
 Original monument Post, wood
(Wood post, stone, pile of stones, pipe, etc.)

Bearing Trees

Species	Tamarack	Tamarack	Tamarack	Tamarack
Diameter	8"	10"	8"	6"
Bearing	N80°E	S25°W	N17°W	S60°E
Distance	9.9'	9.9'	19.8'	13.2'

Subsequent Corner Restoration

Year surveyed _____ By _____
 Where filed or recorded _____
 Monument _____
(Original, concrete post, iron rod, etc.)

Bearing Trees, Reference Objects

Species _____
 Diameter _____
 Bearing _____
 Distance _____

Original Evidence Found

Year of search 1969 By G.H. McDonald
 Monument found None

Original Bearing Trees Found

Species _____
 Diameter _____
 Bearing _____
 Distance _____

Evidence of Subsequent Corner Restoration Found

Year of search _____ By _____

Bearing Trees, Reference Objects

Species _____
 Diameter _____
 Bearing _____
 Distance _____

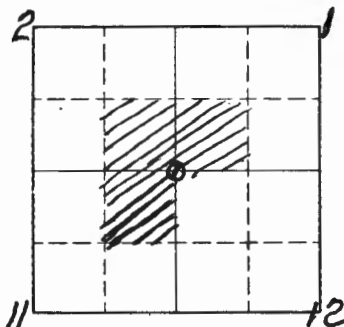

Sketch

○ Corner ▨ F.S. Land

Relation of Evidence to Record Features Along Section Lines

Section line to sections _____
 Object _____
 Record distance _____
 Measured distance _____

Other Evidence

Describe evidence of use and occupation such as roads, fences, clearings, timber cutting lines, plantations, etc.. Cite source of testimony if any. *Found F.S. metal location poster on a 7" cedar put up by Stewart & Kaiser in 1956. No evidence of orig. post or BT'S was found*

At time of search:

1. Did you have the record description?

Yes No _____

2. How was search area located?

Pacing, ~~chaining~~, ~~photos~~, maps, etc. _____

3. Man hours spent in search 3

4. Do you think additional search might recover evidence? Yes No _____

5. Signature *W. M. Donald*

Perpetuation Record

Monument and accessories established. Include brief description of area. _____

Certified corner restoration certificate prepared: Yes _____ No _____

Filed in county records at _____ Date _____ County Document No. _____

Identified on aerial photo No. _____ Which is filed at _____

T. 149 R. 25 5th Mer. N.F. Chippewa County Itasca State Minnesota
N.E. 1116 Corner common to sections _____ and _____

EXISTING SURVEYS

Original Government Survey

Year surveyed _____

Original monument _____
(Wood post, stone, pile of stones, pipe, etc.)

Bearing Trees

Species _____

Diameter _____

Bearing _____

Distance _____

Subsequent Corner Restoration

Year surveyed _____ By _____

Where filed or recorded _____

Monument _____
(Original, concrete post, iron rod, etc.)

Bearing Trees, Reference Objects

Species _____

Diameter _____

Bearing _____

Distance _____

Original Evidence Found

Year of search _____ By _____

Monument found _____

Original Bearing Trees Found

Species _____

Diameter _____

Bearing _____

Distance _____

Evidence of Subsequent Corner Restoration Found

Year of search _____ By _____

Bearing Trees, Reference Objects

Species _____

Diameter _____

Bearing _____

Distance _____

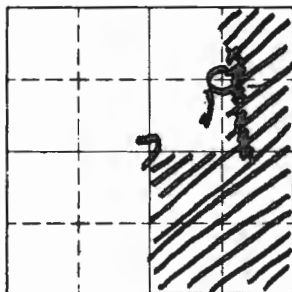

Sketch

○ Corner ▨ F.S. Land

Relation of Evidence to Record Features Along Section Lines

Section line to sections _____
 Object _____
 Record distance _____
 Measured distance _____

Other Evidence

Describe evidence of use and occupation such as roads, fences, clearings, timber cutting lines, plantations, etc.. Cite source of testimony if any. found

At time of search:

1. Did you have the record description?

Yes _____ No _____

2. How was search area located?

Pacing, chaining, photos, maps,
 etc. _____

3. Man hours spent in search _____

4. Do you think additional search might
 recover evidence? Yes _____ No _____

5. Signature _____

Perpetuation Record

Monument and accessories established. Include brief description of area.

I put up F.S.L.P. on the East side of a
 3" Aspen marking approx 1/4 Cor.
 I painted blue line south of cor.

2/77 Ronald O. Olson

Certified corner restoration certificate prepared: Yes _____ No _____

Filed in county records at _____ Date _____ County Document No. _____

Identified on aerial photo No. _____ Which is filed at _____

Index No. G-1
(Alphabetical - Numerical)

LAND CORNER RECORD
(RECTANGULAR SURVEYS)

RS-5480-11 (6/12/64)

T. 149N R. 25-26W 5th Mer. N.F. Chippewa County Itasca State Minnesota
Quarter Corner common to sections 7 12 and

EXISTING SURVEYS

Original Government Survey

Year surveyed 1875
Original monument Wood Post
(Wood post, stone, pile of stones, pipe, etc.)

Bearing Trees

Species Norway Pine Fir
Diameter 20" 7"
Bearing S87°E N46°W
Distance 7.92' 9.24'

Original Evidence Found

Year of search _____ By _____
Monument found _____

Original Bearing Trees Found

Species _____
Diameter _____
Bearing _____
Distance _____

Subsequent Corner Restoration

Year surveyed _____ By _____
Where filed or recorded _____
Monument _____
(Original, concrete post, iron rod, etc.)

Evidence of Subsequent Corner Restoration Found

Year of search _____ By _____

Bearing Trees, Reference Objects

Species _____
Diameter _____
Bearing _____
Distance _____

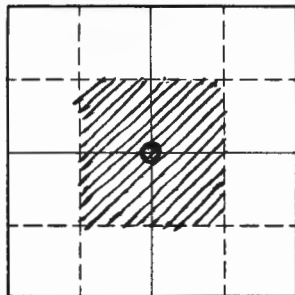

Sketch

○ Corner ▨ F.S. Land

Relation of Evidence to Record Features Along Section Lines

Section line to sections _____
Object _____
Record distance _____
Measured distance _____

Other Evidence

Describe evidence of use and occupation such as roads, fences, clearings, timber cutting lines, plantations, etc. Cite source of testimony if any.

Point for corner falls in a brush chopped area. Orig. evidence has been destroyed.

At time of search:

1. Did you have the record description?

Yes No _____

2. How was search area located?

Pacing, chaining, photos, maps, etc. Photo

3. Man hours spent in search 1

4. Do you think additional search might recover evidence? Yes _____ No

5. Signature [Signature]

Perpetuation Record

Monument and accessories established. Include brief description of area. _____

Certified corner restoration certificate prepared: Yes _____ No _____

Filed in county records at _____ Date _____ County Document No. _____

Identified on aerial photo No. _____ Which is filed at _____

Index No. G-4
(Alphabetical-Numerical)LAND CORNER RECORD
(RECTANGULAR SURVEYS)

R9-7 150-4 (Rev. 6/13/67)

GPO 802-127

T. 149 R. 25 5th Mer. N.F. Chippewa County Iowa State Minnesota
East Center 1/16 Corner common to sections 5 and _____

EXISTING SURVEYS

Original Government Survey

Year surveyed _____

Original monument _____
(Wood post, stone, pile of stones, pipe, etc.)

Bearing Trees

Species _____

Diameter _____

Bearing _____

Distance _____

Subsequent Corner Restoration

Year surveyed _____ By _____

Where filed or recorded _____

Monument _____
(Original, concrete post, iron rod, etc.)

Bearing Trees, Reference Objects

Species _____

Diameter _____

Bearing _____

Distance _____

Original Evidence Found

Year of search _____ By _____

Monument found _____

Original Bearing Trees Found

Species _____

Diameter _____

Bearing _____

Distance _____

Evidence of Subsequent Corner Restoration Found

Year of search _____ By _____

Bearing Trees, Reference Objects

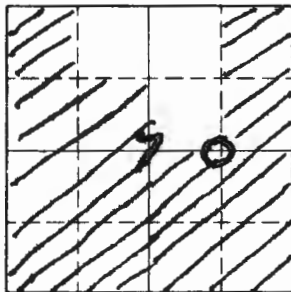

Sketch

○ Corner ▨ F.S. Land

Relation of Evidence to Record Features Along Section Lines

Section line to sections _____
 Object _____
 Record distance _____
 Measured distance _____

Other Evidence

Describe evidence of use and occupation such as roads, fences, clearings, timber cutting lines, plantations, etc.. Cite source of testimony if any. *I found an old F.S. L.P. 70' North of my location*

At time of search:

1. Did you have the record description?

Yes _____ No _____

2. How was search area located?

Pacing, chaining, photos, maps, etc. _____

3. Man hours spent in search _____

4. Do you think additional search might recover evidence? Yes _____ No _____

5. Signature _____

Perpetuation Record

Monument and accessories established. Include brief description of area.

I put up a F.S. L.P. on the East side of a 7" Balm of Gilead marking approx cor. and painted blue lines North & West of Approx Cor

2/77 Donald Olson

Certified corner restoration certificate prepared: Yes _____ No _____

Filed in county records at _____ Date _____ County Document No. _____

Identified on aerial photo No. _____ Which is filed at _____

Index No. G-5
(Alphabetical - Numerical)

LAND CORNER RECORD
(RECTANGULAR SURVEYS)

T. 149N R. 25W Mer. N.F. Chippewa County Itasca State Minnesota
6-5 Corner common to sections 7 and 8

EXISTING SURVEYS

Original Government Survey

Year surveyed _____
 Original monument _____
(Wood post, stone, pile of stones, pipe, etc.)

Bearing Trees

Species _____
 Diameter _____
 Bearing _____
 Distance _____

Subsequent Corner Restoration

Year surveyed _____ By _____
 Where filed or recorded _____
 Monument _____
(Original, concrete post, iron rod, etc.)

Bearing Trees, Reference Objects

Species _____
 Diameter _____
 Bearing _____
 Distance _____

Original Evidence Found

Year of search _____ By _____
 Monument found _____

Original Bearing Trees Found

Species _____
 Diameter _____
 Bearing _____
 Distance _____

Evidence of Subsequent Corner Restoration Found

Year of search _____ By _____

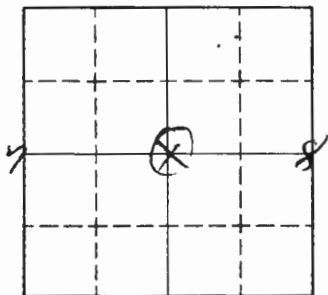

Sketch

○ Corner ▨ F.S. Land

Relation of Evidence to Record Features Along Section Lines

Section line to sections _____
Object _____
Record distance _____
Measured distance _____

Other Evidence

Describe evidence of use and occupation such as roads, fences, clearings, timber cutting lines, plantations, etc.. Cite source of testimony if any. _____

North of FS Road 187 found Scraped Stake 4x4 x 2'

At time of search:

1. Did you have the record description?

Yes _____ No _____

2. How was search area located?

Pacing, chaining, photos, maps,
etc. _____

3. Mon hours spent in search _____

4. Do you think additional search might
recover evidence? Yes _____ No _____

5. Signature *John E. Hansen 11/15/63*

Perpetuation Record

Monument and accessories established. Include brief description of area. _____

Certified corner restoration certificate prepared: Yes _____ No _____

Filed in county records at _____ Date _____ County Document No. _____

Identified on aerial photo No. _____ Which is filed at _____

Index No. G-6
(Alphabetical-Numerical)

LAND CORNER RECORD
(RECTANGULAR SURVEYS)

R9-7150-4 (Rev. 6/13/67)
 GPO 802-127

T. T149N R. 25W 5th Mer. N.F. Chippewa County Itasca State Minnesota
Center West 1/16 Corner common to sections 8 and _____

EXISTING SURVEYS

Original Government Survey	Original Evidence Found
Year surveyed _____	Year of search _____ By _____
Original monument _____ <small>(Wood post, stone, pile of stones, pipe, etc.)</small>	Monument found _____
Bearing Trees	Original Bearing Trees Found
Species _____	Species _____
Diameter _____	Diameter _____
Bearing _____	Bearing _____
Distance _____	Distance _____
Subsequent Corner Restoration	Evidence of Subsequent Corner Restoration Found
Year surveyed _____ By _____	Year of search _____ By _____
Where filed or recorded _____	_____
Monument _____ <small>(Original, concrete post, iron rod, etc.)</small>	_____
_____	_____
_____	_____
Bearing Trees, Reference Objects	Bearing Trees, Reference Objects
Species _____	_____
Diameter _____	_____
Bearing _____	_____
Distance _____	_____

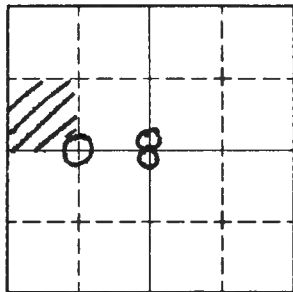

Sketch

○ Corner ▨ F.S. Land

Relation of Evidence to Record Features Along Section Lines

Section line to sections _____
 Object _____
 Record distance _____
 Measured distance _____

Other Evidence

Describe evidence of use and occupation such as roads, fences, clearings, timber cutting lines, plantations, etc.. Cite source of testimony if any.

plantation south and East of Approx cor.

At time of search:

1. Did you have the record description?

Yes _____ No _____

2. How was search area located?

Pacing, chaining, photos, maps,
 etc. _____

3. Man hours spent in search _____

4. Do you think additional search might

recover evidence? Yes _____ No _____

5. Signature _____

Perpetuation Record

Monument and accessories established. Include brief description of area.

*I put up a f.s.l.p. on the North side of
 a 6" Balsam marking approx. 1/16 cor.
 and painted blue line West*

2/77 Ronald Olson

Certified corner restoration certificate prepared:

Yes _____ No _____

Filed in county records at _____

Date _____

County Document No. _____

Identified on aerial photo No. _____

Which is filed at _____

Index No. G-9
(Alphabetical - Numerical)

LAND CORNER RECORD
(RECTANGULAR SURVEYS)

R9-7 150-4 (Rev. 6/13/67)
GPO 808-924

T. 149N R. 25W 5th Mer. N.F. Chippewa County Itasca State MINN.
Quarter Corner common to sections B 9 and _____

EXISTING SURVEYS

Original Government Survey

Year surveyed 1875
Original monument Wood Post
(Wood post, stone, pile of stones, pipe, etc.)

Bearing Trees

Species Tamarack
Diameter 5"
Bearing N2°E
Distance 4.62'

Subsequent Corner Restoration

Year surveyed _____ By _____
Where filed or recorded _____
Monument _____
(Original, concrete post, iron rod, etc.)

Bearing Trees, Reference Objects

Species _____
Diameter _____
Bearing _____
Distance _____

Original Evidence Found

Year of search 1967 By R.H. McDonald
Monument found _____

Original Bearing Trees Found

Species dead Tam.
Diameter 5"
Bearing S2°E
Distance 4.62'

Evidence of Subsequent Corner Restoration Found

Year of search _____ By _____
SEE CORNER AFFIDAVIT

Bearing Trees, Reference Objects

Species _____
Diameter _____
Bearing _____
Distance _____

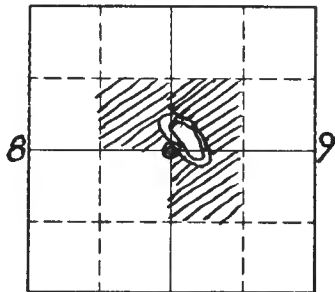

Sketch

○ Corner ▨ F.S. Land

Relation of Evidence to Record Features Along Section Lines

Section line to sections _____
 Object _____
 Record distance _____
 Measured distance _____

Other Evidence

Describe evidence of use and occupation such as roads, fences, clearings, timber cutting lines, plantations, etc., Cite source of testimony if any.

Corner is approx 9' south of waters edge (small pond)

At time of search:

1. Did you have the record description?

Yes No _____

2. How was search area located?

Pacing, chaining, photos, maps, etc. _____

3. Man hours spent in search _____

4. Do you think additional search might recover evidence? Yes _____ No _____

5. Signature

G. M. Donald

Perpetuation Record

Monument and accessories established. Include brief description of area.

Set a 2" ϕ steel pipe with brass cap MKD T149N R25W

Cedar 5" S65°W 31.8' MKD 1/4 S8 BT

S8 1/4 S9

Tamarack 5" S12°E 19.0' MKD 1/4 S9 BT

1967
 RLS NO 6807

Steel sign post w/ F.S. signs

54-2 & 54-4 attached set West 4.6'

Certified corner restoration certificate prepared:

Yes No _____

Filed in county records at _____ Date _____ County Document No. _____

Identified on aerial photo No. _____ Which is filed at _____

Index No. G-13
(Alphabetical - Numerical)

LAND CORNER RECORD
(RECTANGULAR SURVEYS)

R9-7150-4 (Rev. 6/13/67)
GPO 802-127

T. 149 N R. 25 W 5th Mer. N.F. Chippewa County Itasca State Minnesota
114 Corner common to sections 9, 10, and _____

EXISTING SURVEYS

Original Government Survey

Year surveyed 1875
Original monument Wood Post
(Wood post, stone, pile of stones, pipe, etc.)

Bearing Trees

Species Tam Tam
Diameter 10 12
Bearing S47E S71W
Distance 17 24

Subsequent Corner Restoration

Year surveyed _____ By _____
Where filed or recorded _____
Monument _____
(Original, concrete post, iron rod, etc.)

Bearing Trees, Reference Objects

Species _____
Diameter _____
Bearing _____
Distance _____

Original Evidence Found

Year of search 1974 By R. Olesen
Monument found None

Original Bearing Trees Found

Species None
Diameter _____
Bearing _____
Distance _____

Evidence of Subsequent Corner Restoration Found

Year of search _____ By _____

Bearing Trees, Reference Objects

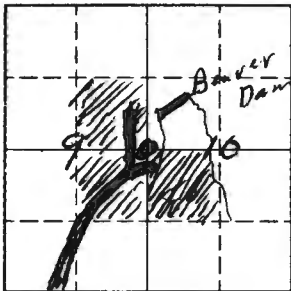

Sketch

○ Corner ▨ F.S. Land

Relation of Evidence to Record Features Along Section Lines

Section line to sections _____
 Object _____
 Record distance _____
 Measured distance _____

Other Evidence

Describe evidence of use and occupation such as roads, fences, clearings, timber cutting lines, plantations, etc.. Cite source of testimony if any. _____

At time of search:

1. Did you have the record description?

Yes _____ No _____

2. How was search area located?

Pacing, chaining, photos, maps,
 etc. _____

3. Mon hours spent in search _____

4. Do you think additional search might

recover evidence? Yes _____ No _____

5. Signature _____

Perpetuation Record

Monument and accessories established. Include brief description of area. _____

Certified corner restoration certificate prepared: Yes _____ No _____

Filed in county records of _____ Date _____ County Document No. _____

Identified on aerial photo No. _____ Which is filed at _____

Index No. G-17
(Alphabetical - Memorial)

LAND CORNER RECORD
(RECTANGULAR SURVEYS)

RG-7 150-4 (Rev. 6/13/67)
 GPO 808-924

T. 149N R. 25W 5th Mer. N.F. Chippewa County Itasca State Maine
Quarter Corner common to sections 10 11 and _____

EXISTING SURVEYS

Original Government Survey

Year surveyed 1975
 Original monument Wood Post
(Wood post, stone, pile of stones, pipe, etc.)

Bearing Trees

Species Elm White Pine
 Diameter 6" 4"
 Bearing N69°W S85°E
 Distance 19.8' 16.5'

Subsequent Corner Restoration

Year surveyed _____ By _____
 Where filed or recorded _____
 Monument _____
(Original, concrete post, iron rod, etc.)

Bearing Trees, Reference Objects

Species _____
 Diameter _____
 Bearing _____
 Distance _____

Original Evidence Found

Year of search 1967 By R.H. McDonald
 Monument found _____

Original Bearing Trees Found

Species _____
 Diameter _____
 Bearing _____
 Distance _____

Evidence of Subsequent Corner Restoration Found

Year of search _____ By _____

Bearing Trees, Reference Objects

Species _____
 Diameter _____
 Bearing _____
 Distance _____

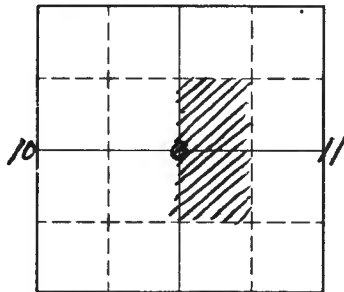

Sketch

○ Corner ▨ F.S. Land

Relation of Evidence to Record Features Along Section Lines

Section line to sections _____
 Object _____
 Record distance _____
 Measured distance _____

Other Evidence

Describe evidence of use and occupation such as roads, fences, clearings, timber cutting lines, plantations, etc.. Cite source of testimony if any. "T" intersection of roads

At time of search:

1. Did you have the record description?

Yes No _____

2. How was search area located?

Pacing, chaining, photos, maps, etc.

3. Man hours spent in search 2

4. Do you think additional search might recover evidence? Yes _____ No

5. Signature W. M. Donald

Perpetuation Record

Monument and accessories established. Include brief description of area. _____

Certified corner restoration certificate prepared: Yes _____ No _____

Filed in county records at _____ Date _____ County Document No. _____

Identified on aerial photo No. _____ Which is filed at _____

T. 149 N R. 25 W S. 5TH Mer. N.F. CHIPPEWA County ITASCA State MINN.
CENTER 1/4 ~~Center common to sections~~ 11 and _____

EXISTING SURVEYS

Original Government Survey	Original Evidence Found
Year surveyed _____	Year of search _____ By _____
Original monument _____ <small>(Wood post, stone, pile of stones, pipe, etc.)</small>	Monument found _____
Bearing Trees	Original Bearing Trees Found
Species _____	Species _____
Diameter _____	Diameter _____
Bearing _____	Bearing _____
Distance _____	Distance _____
Subsequent Corner Restoration	Evidence of Subsequent Corner Restoration Found
Year surveyed _____ By _____	Year of search _____ By _____
Where filed or recorded _____	_____
Monument _____ <small>(Original, concrete post, iron rod, etc.)</small>	_____
_____	_____
_____	_____
Bearing Trees, Reference Objects	Bearing Trees, Reference Objects
Species _____	_____
Diameter _____	_____
Bearing _____	_____
Distance _____	_____

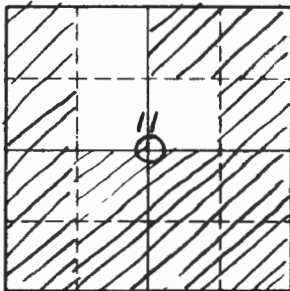

Sketch

○ Corner ▨ F.S. Land

C/4

Relation of Evidence to Record Features Along Section Lines

Section line to sections _____
 Object _____
 Record distance _____
 Measured distance _____

Other Evidence

Describe evidence of use and occupation such as roads, fences, clearings, timber cutting lines, plantations, etc.. Cite source of testimony if any. _____

At time of search:

1. Did you have the record description?

Yes _____ No X

2. How was search area located?

Pacing, chaining, photos, maps,
 etc. _____

3. Mon hours spent in search _____

4. Do you think additional search might

recover evidence? Yes _____ No X

5. Signature DAN MORIARTY

Perpetuation Record

Monument and accessories established. Include brief description of area. _____

ON CEDAR TREE. 13 IN. DBH IN CEDAR STAND
UNSURVEYED FS LOCATION POSTER. FADED YELLOW LINES ON SIDES.
KAISER + STEWART 5/4/55

Certified corner restoration certificate prepared:

Yes _____ No _____

Filed in county records at _____ Date _____ County Document No. _____

Identified on aerial photo No. _____ Which is filed at _____

Index No. H-7
(Alphabetical - Numerical)LAND CORNER RECORD
(RECTANGULAR SURVEYS)R9-7150-4 (Rev. 6/13/67)
GPO 802-127T. 149 N R. 25 W 5th Mer. N.F. Chippewa County Itasca State Minnesota
Center South 1/4 Corner common to sections 8 and _____

EXISTING SURVEYS

Original Government Survey

Year surveyed _____

Original monument _____
(Wood post, stone, pile of stones, pipe, etc.)

Bearing Trees

Species _____

Diameter _____

Bearing _____

Distance _____

Subsequent Corner Restoration

Year surveyed _____ By _____

Where filed or recorded _____

Monument _____
(Original, concrete post, iron rod, etc.)

Bearing Trees, Reference Objects

Species _____

Diameter _____

Bearing _____

Distance _____

Original Evidence Found

Year of search _____ By _____

Monument found _____

Original Bearing Trees Found

Species _____

Diameter _____

Bearing _____

Distance _____

Evidence of Subsequent Corner Restoration Found

Year of search _____ By _____

Bearing Trees, Reference Objects

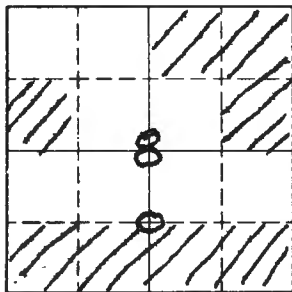

Sketch

○ Corner ▨ F.S. Land

Relation of Evidence to Record Features Along Section Lines

Section line to sections _____
 Object _____
 Record distance _____
 Measured distance _____

Other Evidence

Describe evidence of use and occupation such as roads, fences, clearings, timber cutting lines, plantations, etc.. Cite source of testimony if any. *found old F.S.L.P. 100' East + 45' North of my location*

At time of search:

1. Did you have the record description?

Yes _____ No _____

2. How was search area located?

Pacing, chaining, photos, maps, etc. _____

3. Man hours spent in search _____

4. Do you think additional search might recover evidence? Yes _____ No _____

5. Signature _____

Perpetuation Record

Monument and accessories established. Include brief description of area.

I put up a F.S.L.P. on the East side of a 16" R. Pine marking approx 1/4 cor + painted blue line East + West of approx cor.

2/77 Ronald Olson

Certified corner restoration certificate prepared: Yes _____ No _____

Filed in county records at _____ Date _____ County Document No. _____

Identified on aerial photo No. _____ Which is filed at _____

Index No. H-9
(Alphabetical - Numerical)

LAND CORNER RECORD
(RECTANGULAR SURVEYS)

R9-7150-4 (Rev. 6/13/67)
GPO 802-127

T. 149 N. R. 25 W. Mer. 5th N.F. Chippewa County Itasca State Minn.
SE 1/4 Corner common to sections 8 and _____

EXISTING SURVEYS

Original Government Survey

Year surveyed _____
Original monument _____
(Wood post, stone, pile of stones, pipe, etc.)

Bearing Trees

Species _____
Diameter _____
Bearing _____
Distance _____

Subsequent Corner Restoration

Year surveyed _____ By _____
Where filed or recorded _____
Monument _____
(Original, concrete post, iron rod, etc.)

Bearing Trees, Reference Objects

Species _____
Diameter _____
Bearing _____
Distance _____

Original Evidence Found

Year of search _____ By _____
Monument found _____

Original Bearing Trees Found

Species _____
Diameter _____
Bearing _____
Distance _____

Evidence of Subsequent Corner Restoration Found

Year of search _____ By _____

Bearing Trees, Reference Objects

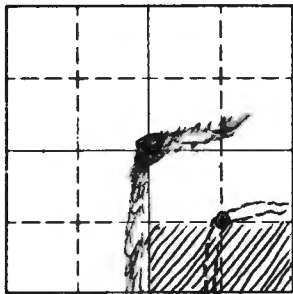

Sketch

○ Corner ▨ F.S. Land

Relation of Evidence to Record Features Along Section Lines

Section line to sections _____
 Object _____
 Record distance _____
 Measured distance _____

Other Evidence

Describe evidence of use and occupation such as roads, fences, clearings, timber cutting lines, plantations, etc.. Cite source of testimony if any. _____

At time of search:

1. Did you have the record description?
 Yes _____ No _____

2. How was search area located?
 Pacing, chaining, photos, maps,
 etc. _____

3. Mon hours spent in search _____

4. Do you think additional search might
 recover evidence? Yes _____ No _____

5. Signature Ronald D. Olson

Perpetuation Record

Monument and accessories established. Include brief description of area.
Placed F.S. Location poster on a 4" Birch west
side, marking approx. 1/16 Cor

Certified corner restoration certificate prepared: Yes _____ No _____
 Filed in county records at _____ Date _____ County Document No. _____
 Identified on aerial photo No. _____ Which is filed at _____

Index File No. J-1 CORNER RECORD (SEARCH) (Ref. FSM 7151.4) Tract or Survey No. _____ Cor. No. _____
 T 149N R. 25-26 R.D. MARCELL County ITASCA
 Merid. 5TH N.F. CHIPPewa State MINN

CORNER DIAGRAM

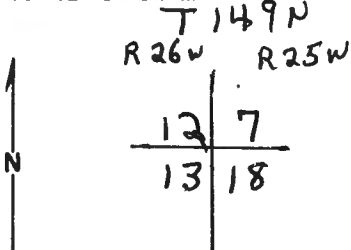

DESCRIBE CORNER MONUMENT FOUND

SQUARED wood post WITH SECTIONS SCRIBED ON IT. SET by J. H. GEIHAUG in 1935

DESCRIBE BEARING TREES OR OTHER OFFICIAL ACCESSORIES FOUND

LOCATION TAG 1962 - KAISER
 " 1935 - GEIHAUG
~~BT's~~ 1" EIM
 Ash 6" 532W
 N30W 131KS 151KS

PHOTO IDENTIFICATION DATA

Photo No. _____
 Filed At. _____
 Object Ident. _____
 Ident. By _____
 Signature _____

PLANE COORDINATE POSITION DATA

State _____ Zone _____
 X _____
 Y _____
 Estab. By _____
 Agency _____

DESCRIBE CORNER LOCATION RELATIVE TO NEAR-BY FEATURES, ALSO HOW TO REACH CORNER

Signature

Title

Division

Headquarters

Date

7100-52 (3/68)

CORNER RECORD (PERPETUATION)

MONUMENT : DESCRIBE NEW MONUMENT SET, OR WORK DONE TO PRESERVE EXISTING MONUMENT

9

ACCESSORIES : DESCRIBE NEW BT's WITNESS OBJECTS ETC. ESTABLISHED, OR WORK DONE TO PRESERVE EXISTING EVIDENCE

10

Work Done By _____ Title _____ Date _____ State Registration No. or Agency _____

Certified Cor. Record Prepared ? Yes No Filed At: _____ Date _____

11

REMARKS

12

Index File No. T. R. M. Tract or Surv. No. Cor, _____

13

Index No. J-3
(Alphabetical - Numerical)

LAND CORNER RECORD
(RECTANGULAR SURVEYS)

R9-5600-11 (5/12/61)

T. 149 N R. 25 W Mer. N.F. Chippewa County Itasca State MINN.
Quarter Corner common to sections 7, 18 and

EXISTING SURVEYS

Original Government Survey

Year surveyed 1875
Original monument Wood post
(Wood post, stone, pile or stones, pipe, etc.)

Bearing Trees

Species White pine White pine
Diameter 8" 10"
Bearing N61°W S71°E
Distance 3.96' 5.28'

Original Evidence Found

Year of search 1969 By RH McDonald
Monument found None

Original Bearing Trees Found

Species _____
Diameter _____
Bearing _____
Distance _____

Subsequent Corner Restoration

Year surveyed _____ By _____
Where filed or recorded _____
Monument _____
(Original, concrete post, iron rod, etc.)

Evidence of Subsequent Corner Restoration Found

Year of search _____ By _____

Bearing Trees, Reference Objects

Species _____
Diameter _____
Bearing _____
Distance _____

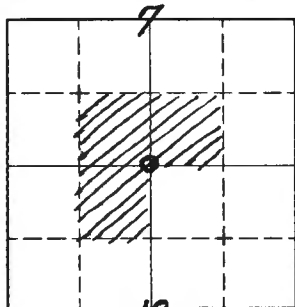

Sketch

○ Corner ▨ F.S. Land

Relation of Evidence to Record Features Along Section Lines

Section line to sections 7-18
 Object Crack
 Record distance 99'
 Measured distance _____

Other Evidence

Describe evidence of use and occupation such as roads, fences, clearings, timber cutting lines, plantations, etc.. Cite source of testimony if any. _____

Perpetuation Record

Monument and accessories established. Include brief description of area. _____

Certified corner restoration certificate prepared: Yes _____ No _____

Filed in county records of _____ Date _____ County Document No. _____

Identified on aerial photo No. _____ Which is filed at _____

At time of search:

1. Did you have the record description?

Yes No _____

2. How was search area located?

Pacing, chaining, photos, maps, etc. Photo & Map

3. Man hours spent in search 3

4. Do you think additional search might recover evidence? Yes _____ No

5. Signature GA McK Donald

T. 149 N R. 25 W 5th Mer. N.F. Chippewa County Itasca State MINN.
Section Corner common to sections 7, 8, 17 and 18

EXISTING SURVEYS

Original Government Survey

Year surveyed 1875
 Original monument Wood Post
(Wood post, stone, pile of stones, pipe, etc.)

Bearing Trees

Species	W. Birch	W. Birch	W. Birch	W. Birch
Diameter	12"	14"	10"	10"
Bearing	S40°E	S70°W	N16°E	N6°W
Distance	11.22'	18.48'	9.24'	4.62'

Subsequent Corner Restoration

Year surveyed _____ By _____
 Where filed or recorded _____
 Monument _____
(Original, concrete post, iron rod, etc.)

Bearing Trees, Reference Objects

Species _____
 Diameter _____
 Bearing _____
 Distance _____

Original Evidence Found

Year of search 1967 By RH. McDonald
 Monument found None

Original Bearing Trees Found

Species _____
 Diameter _____
 Bearing _____
 Distance _____

Evidence of Subsequent Corner Restoration Found

Year of search _____ By _____

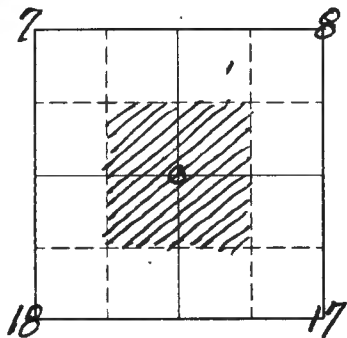

Sketch

○ Corner ▨ F.S. Land

Relation of Evidence to Record Features Along Section Lines

Section line to sections _____
 Object _____
 Record distance _____
 Measured distance _____

Other Evidence

Describe evidence of use and occupation such as roads, fences, clearings, timber cutting lines, plantations, etc.. Cite source of testimony if any. _____

At time of search:

1. Did you have the record description?
 Yes No _____

2. How was search area located?
 Pacing, chaining, photos, maps,
 etc. Chaining from Natural Features

3. Man hours spent in search 4

4. Do you think additional search might recover evidence? Yes _____ No

Perpetuation Record

Monument and accessories established. Include brief description of area. _____

Certified corner restoration certificate prepared: Yes _____ No _____

Filed in county records at _____ Date _____ County Document No. _____

5. Signature [Handwritten Signature]

Identified on aerial photo No. _____ Which is filed at _____

T. 149N R. 25W Mer. N.F. Chippewa County Itasca State Minnesota
Section Corner common to sections 8, 9, 16 and 17

EXISTING SURVEYS

Original Government Survey

Year surveyed 1875
Original monument Wood Post
(Wood post, stone, pile of stones, pipe, etc.)

Bearing Trees

Species	<u>White Pine</u>	<u>White Pine</u>	<u>Black Oak</u>
Diameter	<u>8"</u>	<u>6"</u>	<u>6"</u>
Bearing	<u>S70°E</u>	<u>N41°E</u>	<u>S18°W</u>
Distance	<u>13.86'</u>	<u>2.64'</u>	<u>7.92'</u>

Original Evidence Found

Year of search 1967 By R.H. McDonald
Monument found _____

Original Bearing Trees Found

Species	<u>Pine str.</u>	<u>W. Pine</u>	<u>Oak clump</u>
Diameter	<u>24"</u>		
Bearing	<u>S67°E</u>	<u>N41°E</u>	<u>S20W</u>
Distance	<u>13.8'</u>	<u>2.64'</u>	<u>8.0'</u>

Subsequent Corner Restoration

Year surveyed _____ By _____
Where filed or recorded _____
Monument _____
(Original, concrete post, iron rod, etc.)

Evidence of Subsequent Corner Restoration Found

Year of search _____ By _____
SEE CORNER AFFIDAVIT

Bearing Trees, Reference Objects

Species	_____
Diameter	_____
Bearing	_____
Distance	_____

Bearing Trees, Reference Objects

Species	_____
Diameter	_____
Bearing	_____
Distance	_____

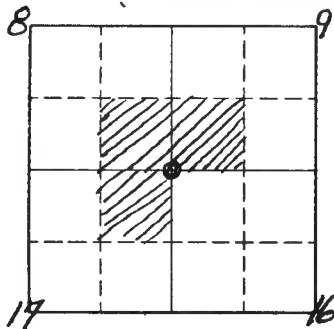

Sketch

○ Corner ▨ F.S. Land

Relation of Evidence to Record Features Along Section Lines

Section line to sections _____
 Object _____
 Record distance _____
 Measured distance _____

Other Evidence

Describe evidence of use and occupation such as roads, fences, clearings, timber cutting lines, plantations, etc.. Cite source of testimony if any.

Found F.S. Metal location poster on the 24" W. Pipe
 B.T. date. 11-3-46 M.F.

At time of search:

1. Did you have the record description?

Yes _____ No _____

2. How was search area located?

Pacing, chaining, photos, maps,
 etc. _____

3. Man hours spent in search _____

4. Do you think additional search might
 recover evidence? Yes _____ No _____

5. Signature

A. M. Donald

Perpetuation Record

Monument and accessories established. Include brief description of area.

Set a 2" ϕ steel pipe w/ brass cap MKD. T149N R25W

S8 | S9
 S17 | S16
 1967
 RLS NO 6807

Oak 6" S24°W 8.4' MKD S17 BT

Spruce 4" S51°E 28.9' MKD S16 BT

Spruce 5" N84°E 52.2' MKD S9 BT

Steel sign post with F.S. signs 54-2
 # 54-4 attached set South 4.5 feet.

Certified corner restoration certificate prepared:

Yes No _____

Filed in county records at _____ Date _____ County Document No. _____

Identified on aerial photo No. _____ Which is filed at _____

Index No. J-11
(Alphabetical - Numerical)

LAND CORNER RECORD
(RECTANGULAR SURVEYS)

R9-7150-4 (Rev. 6/13/67)
GPO 502-127

T. 144 R. 25
14

5th Mer. N.F. Chippewa County Itasca
Corner common to sections 9 16

State Minn.
and _____

EXISTING SURVEYS

Original Government Survey

Year surveyed 1875
Original monument wood Post
(Wood post, stone, pile of stones, pipe, etc.)

Bearing Trees
Species Aspen Aspen
Diameter 6 8
Bearing S10°W N36E
Distance 18 37

Subsequent Corner Restoration

Year surveyed _____ By _____
Where filed or recorded _____
Monument _____
(Original, concrete post, iron rod, etc.)

Bearing Trees, Reference Objects

Species _____
Diameter _____
Bearing _____
Distance _____

Original Evidence Found

Year of search _____ By _____
Monument found _____

Original Bearing Trees Found

Species None
Diameter _____
Bearing _____
Distance _____

Evidence of Subsequent Corner Restoration Found

Year of search _____ By _____

Bearing Trees, Reference Objects

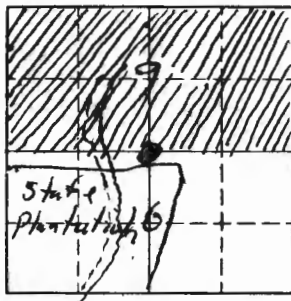

Sketch

○ Corner ▨ F.S. Land

Relation of Evidence to Record Features Along Section Lines

Section line to sections _____
 Object _____
 Record distance _____
 Measured distance _____

Other Evidence

Describe evidence of use and occupation such as roads, fences, clearings, timber cutting lines, plantations, etc.. Cite source of testimony if any. _____

At time of search:

1. Did you have the record description?

Yes X No _____

2. How was search area located?

Pacing chaining, photos maps
 etc. _____

3. Man hours spent in search 1

4. Do you think additional search might recover evidence? Yes _____ No X

5. Signature Ronald D. Olson

Perpetuation Record

Monument and accessories established. Include brief description of area.

Placed a ~~tree~~ Location Poster on the North side of 8" Aspen Marking Approx. 60'

Certified corner restoration certificate prepared: Yes _____ No _____
 Filed in county records at _____ Date _____ County Document No. _____
 Identified on aerial photo No. _____ Which is filed at _____

Index No. J-13
(Alphabetical - Numerical)LAND CORNER RECORD
(RECTANGULAR SURVEYS)R9-7150-4 (Rev. 6/13/67)
GPO 802-127T. 149 N R. 25 W 5th Mer. N.F. Chippewa County Itasca State Minnesota
Sec Corner common to sections 9, 10, 15 and 16

EXISTING SURVEYS

Original Government Survey

Year surveyed 1875
Original monument Wood Post.
(Wood post, stone, pile of stones, pipe, etc.)

Bearing Trees

Species	<u>Maple</u>	<u>Maple</u>	<u>Maple</u>	<u>W Birch</u>
Diameter	<u>8"</u>	<u>8"</u>	<u>12"</u>	<u>12"</u>
Bearing	<u>N20°W</u>	<u>S15°W</u>	<u>N40°E</u>	<u>S7°E</u>
Distance	<u>29</u>	<u>5</u>	<u>23</u>	<u>30</u>

Subsequent Corner Restoration

Year surveyed _____ By _____
Where filed or recorded _____
Monument _____
(Original, concrete post, iron rod, etc.)

Bearing Trees, Reference Objects

Species _____
Diameter _____
Bearing _____
Distance _____

Original Evidence Found

Year of search 1974 By R. Olson
Monument found None

Original Bearing Trees Found

Species	<u>Maple</u>	_____	_____	_____
Diameter	<u>8"</u>	_____	_____	_____
Bearing	<u>N20°W</u>	_____	_____	_____
Distance	<u>29</u>	_____	_____	_____

Evidence of Subsequent Corner Restoration Found

Year of search _____ By _____

Bearing Trees, Reference Objects

Species _____
Diameter _____
Bearing _____
Distance _____

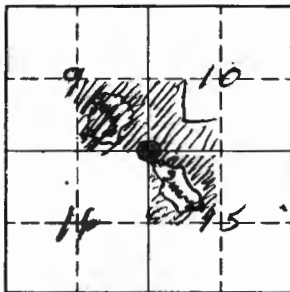

Sketch

○ Corner ▨ F.S. Land

Relation of Evidence to Record Features Along Section Lines

Section line to sections _____
 Object _____
 Record distance _____
 Measured distance _____

Other Evidence

Describe evidence of use and occupation such as roads, fences, clearings, timber cutting lines, plantations, etc.. Cite source of testimony if any. _____

At time of search:

1. Did you have the record description?

Yes No

2. How was search area located?

Pacing, chaining, photos, maps, etc.

3. Man hours spent in search 2

4. Do you think additional search might recover evidence? Yes No _____

5. Signature Ronald D. Olson

Perpetuation Record

Monument and accessories established. Include brief description of area. _____

I put up a F.S. Location poster on a 12" Maple which is original Bearing tree. Scribing on tree faces South 20° East.

There are an old blazed line running North & South from the area of the cor which I believe is only Deer Hunter blazes.

Certified corner restoration certificate prepared: Yes _____ No _____

Filed in county records of _____ Date _____ County Document No. _____

Identified on aerial photo No. _____ Which is filed at _____

Index No. J-13
(Alphabetical - Roman)LAND CORNER RECORD
(RECTANGULAR SURVEYS)R9-7150-4 (Rev. 6/13/67)
GPO 502-127T. 149 N R. 25 W 5th Mer. N.F. Chippewa County Itasca State Minnesota
Sec. Corner common to sections 9, 10, 15 and 16

EXISTING SURVEYS

Original Government Survey

Year surveyed 1875
Original monument Wood Post
(Wood post, stone, pile of stones, pipe, etc.)

Bearing Trees

Species	Maple	Maple	Maple	W. Birch
Diameter	8	8"	12"	12"
Bearing	N 20° W	S 15° W	N 40° E	S 70° E
Distance	29	5	23	

Subsequent Corner Restoration

Year surveyed _____ By _____
Where filed or recorded _____
Monument _____
(Original, concrete post, iron rod, etc.)*Monumented
1875*

Bearing Trees, Reference Objects

Species _____
Diameter _____
Bearing _____
Distance _____

Original Evidence Found

Year of search _____ By _____
Monument found _____

Original Bearing Trees Found

Species	Maple		
Diameter	12"		
Bearing	N 20° W		
Distance	29		

Evidence of Subsequent Corner Restoration Found

Year of search _____ By _____

Bearing Trees, Reference Objects

Species _____
Diameter _____
Bearing _____
Distance _____

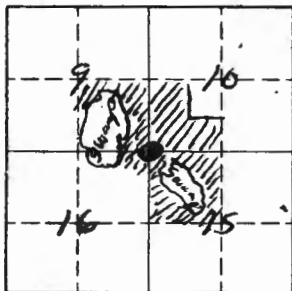

Sketch

○ Corner ▨ F.S. Land

Relation of Evidence to Record Features Along Section Lines

Section line to sections _____
 Object _____
 Record distance _____
 Measured distance _____

Other Evidence

Describe evidence of use and occupation such as roads, fences, clearings, timber cutting lines, plantations, etc.. Cite source of testimony if any. _____

At time of search:

1. Did you have the record description?

Yes _____ No

2. How was search area located?

Pacing chaining, photos, maps, etc. _____

3. Man hours spent in search 2

4. Do you think additional search might recover evidence? Yes No _____

5. Signature Ronald D. Olson

Perpetuation Record

Monument and accessories established. Include brief description of area.
I put up a F.S. location marker on a 12" Maple which is original bearing tree. Scribing on tree faces S 20° E and is very visible and in good condition but should be monumented soon. I ran a blue line south approx 2000' from cur.

May 1974

Certified corner restoration certificate prepared: Yes _____ No _____

Filed in county records at _____ Date _____ County Document No. _____

Identified on aerial photo No. _____ Which is filed at _____

T. 149 R. 25W S. 5 Mer. N.F. CHIPPEWA County ITASCA State MN
SEC Corner common to sections 10, 11, 14 and 15

EXISTING SURVEYS

Original Government Survey	Original Evidence Found
Year surveyed _____	Year of search _____ By _____
Original monument _____ <small>(Wood post, stone, pile of stones, pipe, etc.)</small>	Monument found _____
Bearing Trees	Original Bearing Trees Found
Species _____	Species _____
Diameter _____	Diameter _____
Bearing _____	Bearing _____
Distance _____	Distance _____
Subsequent Corner Restoration	Evidence of Subsequent Corner Restoration Found
Year surveyed _____ By _____	Year of search _____ By _____
Where filed or recorded _____	_____
Monument _____ <small>(Original, concrete post, iron rod, etc.)</small>	_____
_____	_____
_____	_____
Bearing Trees, Reference Objects	Bearing Trees, Reference Objects
Species _____	_____
Diameter _____	_____
Bearing _____	_____
Distance _____	_____

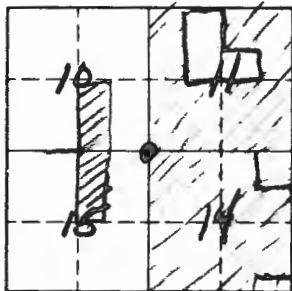

Sketch

○ Corner ▨ F.S. Land

Relation of Evidence to Record Features Along Section Lines

Section line to sections _____
 Object _____
 Record distance _____
 Measured distance _____

Other Evidence

Describe evidence of use and occupation such as roads, fences, clearings, timber cutting lines, plantations, etc.. Cite source of testimony if any. Metal pipe

At time of search:

1. Did you have the record description?

Yes _____ No _____

2. How was search area located?

Pacing, chaining, photos, maps, etc. chaining

3. Man hours spent in search _____

4. Do you think additional search might recover evidence? Yes _____ No _____

5. Signature S. Case

Perpetuation Record

Monument and accessories established. Include brief description of area. _____

Certified corner restoration certificate prepared: Yes _____ No _____

Filed in county records at _____ Date _____ County Document No. _____

Identified on aerial photo No. _____ Which is filed at _____

Index No. J-20
(Alphabetical - Numerical)

LAND CORNER RECORD
(RECTANGULAR SURVEYS)

R9-7150-4 (Rev. 6/13/67)
 GPO 502-127

T. 149N R. 25W 5th Mer. N.F. Chippewa County Itasca State Minnesota
East 1/16 Corner common to sections 11 1 14 and _____

EXISTING SURVEYS

Original Government Survey	Original Evidence Found
Year surveyed _____	Year of search _____ By _____
Original monument _____ <small>(Wood post, stone, pile of stones, pipe, etc.)</small>	Monument found _____
Bearing Trees	Original Bearing Trees Found
Species _____	Species _____
Diameter _____	Diameter _____
Bearing _____	Bearing _____
Distance _____	Distance _____
Subsequent Corner Restoration	Evidence of Subsequent Corner Restoration Found
Year surveyed _____ By _____	Year of search _____ By _____
Where filed or recorded _____	_____
Monument _____ <small>(Original, concrete post, iron rod, etc.)</small>	_____
_____	_____
_____	_____
Bearing Trees, Reference Objects	Bearing Trees, Reference Objects
Species _____	_____
Diameter _____	_____
Bearing _____	_____
Distance _____	_____

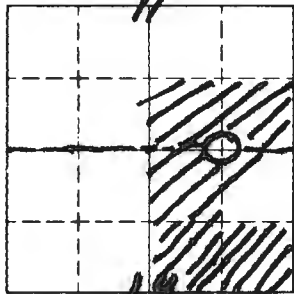

Sketch

○ Corner ▨ F.S. Land

Relation of Evidence to Record Features Along Section Lines

Section line to sections _____
 Object _____
 Record distance _____
 Measured distance _____

Other Evidence

Describe evidence of use and occupation such as roads, fences, clearings, timber cutting lines, plantations, etc.. Cite source of testimony if any. _____

At time of search:

1. Did you have the record description?

Yes _____ No _____

2. How was search area located?

Pacing, chaining, photos, maps,
 etc. _____

3. Man hours spent in search _____

4. Do you think additional search might
 recover evidence? Yes _____ No _____

5. Signature _____

Perpetuation Record

Monument and accessories established. Include brief description of area.

*I put up a K.S.L.P. on the South Side of a
 7" Balsam marking approx 1/16 Cor. Old plow
 line running East & West. I painted blue
 line South of cor.*

*4/11/76
 Ronald Olson*

Certified corner restoration certificate prepared: Yes _____ No _____

Filed in county records at _____ Date _____ County Document No. _____

Identified on aerial photo No. _____ Which is filed at _____

Index No. J-21
(Alphabetical-Numerical)LAND CORNER RECORD
(RECTANGULAR SURVEYS)R9-7150-4 (Rev. 6/13/67)
GPO 808-924T. 149N R. 25W 5th Mer. N.F. Chippewa County Itasca State MINN
Section Corner common to sections 11, 12, 13 and 14

EXISTING SURVEYS

Original Government Survey

Year surveyed 1875
Original monument Wood Post
(wood post, stone, pile of stones, pipe, etc.)

Bearing Trees

Species	Tamarack	Tamarack	Cedar	Cedar
Diameter	10"	8"	12"	8"
Bearing	S49°E	N55°E	S37°W	N43°W
Distance	1.98'	17.16'	8.58'	6.6'

Subsequent Corner Restoration

Year surveyed _____ By _____
Where filed or recorded _____
Monument _____
(Original, concrete post, iron rod, etc.)

Bearing Trees, Reference Objects

Species	_____	_____	_____
Diameter	_____	_____	_____
Bearing	_____	_____	_____
Distance	_____	_____	_____

Original Evidence Found

Year of search 1969 By R.H. McDonald
Monument found None

Original Bearing Trees Found

Species	_____	_____	_____
Diameter	_____	_____	_____
Bearing	_____	_____	_____
Distance	_____	_____	_____

Evidence of Subsequent Corner Restoration Found

Year of search _____ By _____

Bearing Trees, Reference Objects

Species	_____	_____	_____
Diameter	_____	_____	_____
Bearing	_____	_____	_____
Distance	_____	_____	_____

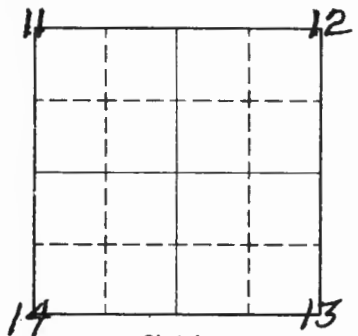

Sketch

○ Corner ▨ F.S. Land

Relation of Evidence to Record Features Along Section Lines

Section line to sections	_____	_____	_____
Object	_____	_____	_____
Record distance	_____	_____	_____
Measured distance	_____	_____	_____

Other Evidence

Describe evidence of use and occupation such as roads, fences, clearings, timber cutting lines, plantations, etc.. Cite source of testimony if any. Found F.S. metal location poster on a 12" cedar. - Put up in 1956 by Kaiser & Stewart says approx. corner. No evidence of orig. BTs was found.

I find this tag to be 5160' from Hwy #6 & believe the cor should be approx 120' west of that location 4/1/76 ^{found then}

Perpetuation Record

Monument and accessories established. Include brief description of area. _____

At time of search:

1. Did you have the record description?

Yes No _____

2. How was search area located?

Pacing, chaining, photos, maps,
etc. _____

3. Man hours spent in search 4

4. Do you think additional search might recover evidence? Yes _____ No

Certified corner restoration certificate prepared:

Yes _____ No _____

Filed in county records at _____ Date _____ County Document No. _____

5. Signature Robert H. McDonald

Identified on aerial photo No. _____ Which is filed at _____

Index No. J-23
(Alphabetical - Numerical)

LAND CORNER RECORD
(RECTANGULAR SURVEYS)

R9-7150-4 (Rev. 6/13/67)
 GPO 502-127

T. 149 N R. 25 W 5th Mer. N.F. Chippewa County Itasca State Minnesota
1/4 Corner common to sections 12, 13, and _____

EXISTING SURVEYS

Original Government Survey

Year surveyed _____
 Original monument Post
(Wood post, stone, pile of stones, pipe, etc.)

Bearing Trees

Species	<u>Cedar</u>	<u>Cedar</u>	_____
Diameter	<u>6"</u>	<u>8"</u>	_____
Bearing	<u>N39°E</u>	<u>S92°E</u>	_____
Distance	<u>61/2</u>	<u>11/2</u>	_____

Original Evidence Found

Year of search _____ By _____
 Monument found _____

Original Bearing Trees Found

Species	<u>None</u>	_____	_____
Diameter	_____	_____	_____
Bearing	_____	_____	_____
Distance	_____	_____	_____

Subsequent Corner Restoration

Year surveyed _____ By _____
 Where filed or recorded _____
 Monument _____
(Original, concrete post, iron rod, etc.)

Evidence of Subsequent Corner Restoration Found

Year of search _____ By _____

Bearing Trees, Reference Objects

Species	_____	_____	_____
Diameter	_____	_____	_____
Bearing	_____	_____	_____
Distance	_____	_____	_____

Bearing Trees, Reference Objects

Species	_____	_____	_____
Diameter	_____	_____	_____
Bearing	_____	_____	_____
Distance	_____	_____	_____

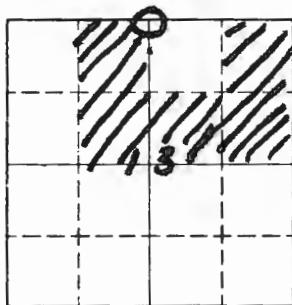

Sketch

○ Corner ▨ F.S. Land

Relation of Evidence to Record Features Along Section Lines

Section line to sections _____
 Object _____
 Record distance _____
 Measured distance _____

Other Evidence

Describe evidence of use and occupation such as roads, fences, clearings, timber cutting lines, plantations, etc.. Cite source of testimony if any.

At time of search:

1. Did you have the record description?

Yes _____ No _____

2. How was search area located?

Pacing, chaining, photos, maps,
 etc. _____

3. Man hours spent in search _____

4. Do you think additional search might
 recover evidence? Yes _____ No _____

5. Signature _____

Perpetuation Record

Monument and accessories established. Include brief description of area.

*I set up a F.S. L.P. on the west side of a
 4th Balsam marking approx 1/4th cor. I
 painted blue line south of cor.*

4/1/76

Ronald Olson

Certified corner restoration certificate prepared: Yes _____ No _____

Filed in county records at _____ Date _____ County Document No. _____

Identified on aerial photo No. _____ Which is filed at _____

Index No. J-25
(Alphabetical - Numerical)

LAND CORNER RECORD
(RECTANGULAR SURVEYS)

T. 149 N R25W Mer. N.F. 57th Chippewa County Stacia State MINNESOTA
J-25 Corner common to sections 12 and 13

EXISTING SURVEYS

Original Government Survey

Year surveyed _____
Original monument _____
(Wood post, stone, pile of stones, pipe, etc.)

Bearing Trees

Species _____
Diameter _____
Bearing _____
Distance _____

Subsequent Corner Restoration

Year surveyed _____ By _____
Where filed or recorded _____
Monument _____
(Original, concrete post, iron rod, etc.)

Bearing Trees, Reference Objects

Species _____
Diameter _____
Bearing _____
Distance _____

Original Evidence Found

Year of search _____ By _____
Monument found _____

Original Bearing Trees Found

Species _____
Diameter _____
Bearing _____
Distance _____

Evidence of Subsequent Corner Restoration Found

Year of search _____ By _____

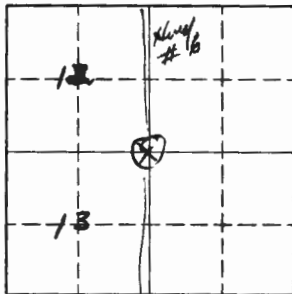

Sketch

○ Corner F.S. Land

Relation of Evidence to Record Features Along Section Lines

Section line to sections _____
 Object _____
 Record distance _____
 Measured distance _____

Other Evidence

Describe evidence of use and occupation such as roads, fences, clearings, timber cutting lines, plantations, etc.. Cite source of testimony if any. _____

*Concrete broken up by some heavy equipment contained brass cap.
 west side of road. So. End of D. Davis field.*

At time of search:

1. Did you have the record description?

Yes _____ No _____

2. How was search area located?

Pacing, chaining, photos, maps,
 etc. _____

3. Man hours spent in search _____

4. Do you think additional search might
 recover evidence? Yes _____ No _____

5. Signature *Shelton K. Krasin* 11/19/63

Perpetuation Record

Monument and accessories established. Include brief description of area. _____

Certified corner restoration certificate prepared: Yes _____ No _____

Filed in county records at _____ Date _____ County Document No. _____

Identified on aerial photo No. _____ Which is filed at _____

Index No. K-20
(Alphabetical - Numerical)LAND CORNER RECORD
(RECTANGULAR SURVEYS)R9-7150-4 (Rev. 6/13/67)
GPO 802-127T. 149 N. R. 25 W.
N.E. 1/16Mer. N.F. 5TH Chippewa County Itasca State Minnesota
Corner common to sections 14 and _____

EXISTING SURVEYS

Original Government Survey

Year surveyed _____

Original monument _____
(Wood post, stone, pile of stones, pipe, etc.)

Bearing Trees

Species _____

Diameter _____

Bearing _____

Distance _____

Subsequent Corner Restoration

Year surveyed _____ By _____

Where filed or recorded _____

Monument _____
(Original, concrete post, iron rod, etc.)

Bearing Trees, Reference Objects

Species _____

Diameter _____

Bearing _____

Distance _____

Original Evidence Found

Year of search _____ By _____

Monument found _____

Original Bearing Trees Found

Species _____

Diameter _____

Bearing _____

Distance _____

Evidence of Subsequent Corner Restoration Found

Year of search _____ By _____

Bearing Trees, Reference Objects

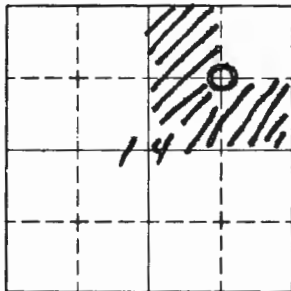

Sketch

○ Corner ▨ F.S. Land

Relation of Evidence to Record Features Along Section Lines

Section line to sections _____
 Object _____
 Record distance _____
 Measured distance _____

Other Evidence

Describe evidence of use and occupation such as roads, fences, clearings, timber cutting lines, plantations, etc.. Cite source of testimony if any.

At time of search:

1. Did you have the record description?

Yes _____ No _____

2. How was search area located?

Pacing, chaining, photos, maps,
 etc. _____

3. Man hours spent in search _____

4. Do you think additional search might

recover evidence? Yes _____ No _____

5. Signature _____

Perpetuation Record

Monument and accessories established. Include brief description of area.

*I put up a F.S. L.P. on the South West Side of a
 8" Balsam marking Approx. 1/6 cor. I Painted
 blue line North of cor.*

4/1/76

Donald Abner

Certified corner restoration certificate prepared: Yes _____ No _____

Filed in county records at _____ Date _____ County Document No. _____

Identified on aerial photo No. _____ Which is filed at _____

Index No. K-23
(Alphabetical - Numerical)LAND CORNER RECORD
(RECTANGULAR SURVEYS)

R9-7150-4 (Rev. 6/13/67)

GPO 902-127

T. 149 N. R. 25W
Center North 1/16Mer. N.F. 5th Chippewa County Itasca State Minnesota
Corner common to sections 13 and _____

EXISTING SURVEYS

Original Government Survey

Year surveyed _____

Original monument _____
(Wood post, stone, pile of stones, pipe, etc.)

Bearing Trees

Species _____

Diameter _____

Bearing _____

Distance _____

Subsequent Corner Restoration

Year surveyed _____ By _____

Where filed or recorded _____

Monument _____
(Original, concrete post, iron rod, etc.)

Bearing Trees, Reference Objects

Species _____

Diameter _____

Bearing _____

Distance _____

Original Evidence Found

Year of search _____ By _____

Monument found _____

Original Bearing Trees Found

Species _____

Diameter _____

Bearing _____

Distance _____

Evidence of Subsequent Corner Restoration Found

Year of search _____ By _____

Bearing Trees, Reference Objects

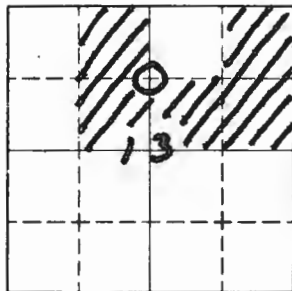

Sketch

○ Corner ▨ F.S. Land

Relation of Evidence to Record Features Along Section Lines

Section line to sections _____
 Object _____
 Record distance _____
 Measured distance _____

Other Evidence

Describe evidence of use and occupation such as roads, fences, clearings, timber cutting lines, plantations, etc.. Cite source of testimony if any. _____

At time of search:

1. Did you have the record description?

Yes _____ No _____

2. How was search area located?

Pacing, chaining, photos, maps, etc. _____

3. Man hours spent in search _____

4. Do you think additional search might recover evidence? Yes _____ No _____

5. Signature _____

Perpetuation Record

Monument and accessories established. Include brief description of area. _____

I put up F.S. L.P. on the west side of a 10" Aspen marking Approx 1/16 cor. I painted blue lines North & East of cor

*4/1/76
 Rod Olson*

Certified corner restoration certificate prepared: Yes _____ No _____

Filed in county records at _____ Date _____ County Document No. _____

Identified on aerial photo No. _____ Which is filed at _____

Index No. K-24
(Alphabetical - Numerical)LAND CORNER RECORD
(RECTANGULAR SURVEYS)

R9-7150-4 (Rev. 6/13/67)

GPO 802-127

T. 149 N R. 25 W
N.E. 1/16Mer. N.F. 5th Chippewa County Ellsworth State Minnesota
Corner common to sections 73 and _____

EXISTING SURVEYS

Original Government Survey

Year surveyed _____

Original monument _____
(Wood post, stone, pile of stones, pipe, etc.)

Bearing Trees

Species _____

Diameter _____

Bearing _____

Distance _____

Subsequent Corner Restoration

Year surveyed _____ By _____

Where filed or recorded _____

Monument _____
(Original, concrete post, iron rod, etc.)

Bearing Trees, Reference Objects

Species _____

Diameter _____

Bearing _____

Distance _____

Original Evidence Found

Year of search _____ By _____

Monument found _____

Original Bearing Trees Found

Species _____

Diameter _____

Bearing _____

Distance _____

Evidence of Subsequent Corner Restoration Found

Year of search _____ By _____

Bearing Trees, Reference Objects



Sketch

○ Corner ▨ F.S. Land

Relation of Evidence to Record Features Along Section Lines

Section line to sections _____
 Object _____
 Record distance _____
 Measured distance _____

Other Evidence

Describe evidence of use and occupation such as roads, fences, clearings, timber cutting lines, plantations, etc.. Cite source of testimony if any.

At time of search:

1. Did you have the record description?

Yes _____ No _____

2. How was search area located?

Pacing, chaining, photos, maps,
 etc. _____

3. Man hours spent in search _____

4. Do you think additional search might
 recover evidence? Yes _____ No _____

5. Signature _____

Perpetuation Record

Monument and accessories established. Include brief description of area.

*I put up a F.S. M.P. on the East side of a
 3" Ash marking approx 1/16 Cor blue line
 painted west of Cor*

*4/11/76
 Ronald Chen*

Certified corner restoration certificate prepared:

Yes _____ No _____

Filed in county records at _____ Date _____

County Document No. _____

Identified on aerial photo No. _____

Which is filed at _____

Index No. L-1
(Alphabetical - Numerical)

LAND CORNER RECORD
(RECTANGULAR SURVEYS)

RS-5680-11 (8/12/84)

T. 149 N R. 25-26 W 5th Mer. N.F. Chippewa County Itasca State MINN.
Quarter Corner common to sections 18, 13 and

EXISTING SURVEYS

Original Government Survey

Year surveyed 1875
Original monument Wood Post
(Wood post, stone, pile of stones, pipe, etc.)

Bearing Trees

Species White Birch Tamarack
Diameter 3" 10"
Bearing East N74°W
Distance 14.52' 11.22'

Subsequent Corner Restoration

Year surveyed _____ By _____
Where filed or recorded _____
Monument _____
(Original, concrete post, iron rod, etc.)

Bearing Trees, Reference Objects

Species _____
Diameter _____
Bearing _____
Distance _____

Original Evidence Found

Year of search 1969 By RH McDonald
Monument found None

Original Bearing Trees Found

Species _____
Diameter _____
Bearing _____
Distance _____

Evidence of Subsequent Corner Restoration Found

Year of search _____ By _____

Relation of Evidence to Record Features Along Section Lines

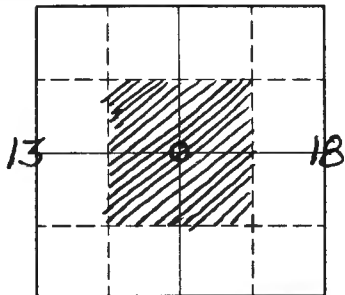

Sketch

○ Corner ▨ F.S. Land

Section line to sections _____
 Object _____
 Record distance _____
 Measured distance _____

Other Evidence

Describe evidence of use and occupation such as roads, fences, clearings, timber cutting lines, plantations, etc.. Cite source of testimony if any. Found F.S. metal location poster put up by J. H. Gelhaus in 1935. Found a decayed Tam. Stp at record bearing & distance.

At time of search:

1. Did you have the record description?

Yes No _____

2. How was search area located?

Pacing, chaining, photos, maps, etc. Chaining

3. Man hours spent in search 2

4. Do you think additional search might recover evidence? Yes No _____

5. Signatur G. M. Donald

Perpetuation Record

Monument and accessories established. Include brief description of area. _____

Certified corner restoration certificate prepared: Yes _____ No _____

Filed in county records at _____ Date _____ County Document No. _____

Identified on aerial photo No. _____ Which is filed at _____

T. 149 N R. 25 W 5th Mer. N.F. Chippewa County Itasca State Minnesota
C 1/4 Corner common to sections 18 and _____

EXISTING SURVEYS

Original Government Survey

Year surveyed _____
Original monument _____
(Wood post, stone, pile of stones, pipe, etc.)

Bearing Trees

Species _____
Diameter _____
Bearing _____
Distance _____

Subsequent Corner Restoration

Year surveyed _____ By _____
Where filed or recorded _____
Monument _____
(Original, concrete post, iron rod, etc.)

Bearing Trees, Reference Objects

Species _____
Diameter _____
Bearing _____
Distance _____

Original Evidence Found

Year of search _____ By _____
Monument found _____

Original Bearing Trees Found

Species _____
Diameter _____
Bearing _____
Distance _____

Evidence of Subsequent Corner Restoration Found

Year of search _____ By _____

Bearing Trees, Reference Objects

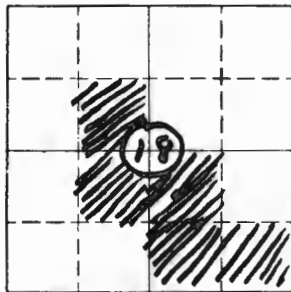

Sketch

○ Corner ▨ F.S. Land

Relation of Evidence to Record Features Along Section Lines

Section line to sections _____
 Object _____
 Record distance _____
 Measured distance _____

Other Evidence

Describe evidence of use and occupation such as roads, fences, clearings, timber cutting lines, plantations, etc.. Cite source of testimony if any.

At time of search:

1. Did you have the record description?

Yes _____ No _____

2. How was search area located?

Pacing, chaining, photos, maps, etc. _____

3. Man hours spent in search _____

4. Do you think additional search might recover evidence? Yes _____ No _____

5. Signature _____

Perpetuation Record

Monument and accessories established. Include brief description of area.

I put up F.S. L.P. on the North side of a 4" Ash marking Approx Center 1/4 Cor. blue line running North & East of Cor.

*1-75
 Ronald Olson*

Certified corner restoration certificate prepared: Yes _____ No _____

Filed in county records at _____ Date _____ County Document No. _____

Identified on aerial photo No. _____ Which is filed at _____

T. 149 N R. 25 W 5th Mer. N.F. Chippewa County Itasca State Minnesota
E 1116 Corner common to sections 18 and _____

EXISTING SURVEYS

Original Government Survey

Year surveyed _____

Original monument _____
(Wood post, stone, pile of stones, pipe, etc.)

Bearing Trees

Species _____

Diameter _____

Bearing _____

Distance _____

Original Evidence Found

Year of search _____ By _____

Monument found _____

Original Bearing Trees Found

Species _____

Diameter _____

Bearing _____

Distance _____

Subsequent Corner Restoration

Year surveyed _____ By _____

Where filed or recorded _____

Monument _____
(Original, concrete post, iron rod, etc.)

Evidence of Subsequent Corner Restoration Found

Year of search _____ By _____

Bearing Trees, Reference Objects

Species _____

Diameter _____

Bearing _____

Distance _____

Bearing Trees, Reference Objects

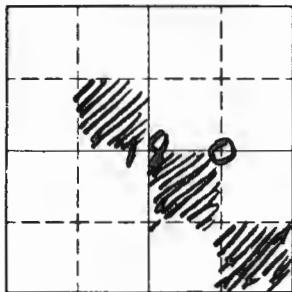

Sketch

○ Corner ▨ F.S. Land

Relation of Evidence to Record Features Along Section Lines

Section line to sections _____
 Object _____
 Record distance _____
 Measured distance _____

Other Evidence

Describe evidence of use and occupation such as roads, fences, clearings, timber cutting lines, plantations, etc.. Cite source of testimony if any. _____

At time of search:

1. Did you have the record description?

Yes _____ No _____

2. How was search area located?

Pacing, chaining, photos, maps, etc. _____

3. Man hours spent in search _____

4. Do you think additional search might recover evidence? Yes _____ No _____

5. Signature _____

Perpetuation Record

Monument and accessories established. Include brief description of area.

I put up F.S.L.P. on the North Side of 12" Cedar marking approx 1/16 cor blue line running South & West of cor

*1-75
 Ronald Olson*

Certified corner restoration certificate prepared: Yes _____ No _____

Filed in county records at _____ Date _____ County Document No. _____

Identified on aerial photo No. _____ Which is filed at _____

Index No. L-5
(Alphabetical - Numerical)

LAND CORNER RECORD
(RECTANGULAR SURVEYS)

RD-7150-4 (Rev. 6/13/67)
 GPO 808-924

T. 149N R. 25W 5th Mer. N.F. Chippewa County Itasca State MINN.
Quarter Corner common to sections 17, 18, and _____

EXISTING SURVEYS

Original Government Survey

Year surveyed 1875
 Original monument Wood Post
(Wood post, stone, pile of stones, pipe, etc.)

Bearing Trees

Species Tamarack Tamarack
 Diameter 6" 6"
 Bearing S83°E N34°W
 Distance 4.62' 14.52'

Subsequent Corner Restoration

Year surveyed _____ By _____
 Where filed or recorded _____
 Monument _____
(Original, concrete post, iron rod, etc.)

Bearing Trees, Reference Objects

Species _____
 Diameter _____
 Bearing _____
 Distance _____

Original Evidence Found

Year of search 1967 By R.H. McDonald
 Monument found None

Original Bearing Trees Found

Species _____
 Diameter _____
 Bearing _____
 Distance _____

Evidence of Subsequent Corner Restoration Found

Year of search _____ By _____

Bearing Trees, Reference Objects

Species _____
 Diameter _____
 Bearing _____
 Distance _____

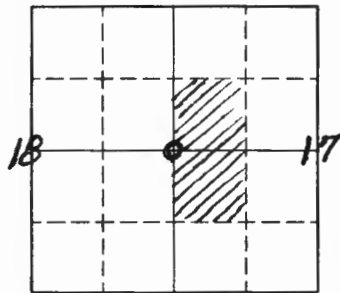

Sketch

○ Corner ▨ F.S. Land

Relation of Evidence to Record Features Along Section Lines

Section line to sections 17-18
 Object Creek
 Record distance 363' North
 Measured distance _____

Other Evidence

Describe evidence of use and occupation such as roads, fences, clearings, timber cutting lines, plantations, etc.. Cite source of testimony if any.

* Area was partly flooded and ice covered when search was made - possibly in a dry year this corner could be located.

At time of search:

1. Did you have the record description?

Yes No _____

2. How was search area located?

Pacing, chaining, photos, maps,

etc. Photos & chaining to natural features

3. Man hours spent in search 4

4. Do you think additional search might recover evidence? Yes No _____

5. Signature AM Donald

Perpetuation Record

Monument and accessories established. Include brief description of area.

Certified corner restoration certificate prepared: Yes _____ No _____

Filed in county records at _____ Date _____ County Document No. _____

Identified on aerial photo No. _____ Which is filed at _____

Index No. L-9
(Alphabetical - Numerical)LAND CORNER RECORD
(RECTANGULAR SURVEYS)R9-7150-4 (Rev. 6/13/67)
GPO 806-924T. 149 N R. 25 W 5th Mer. N.F. Chippewa County Itasca State MINN.
Quarter Corner common to sections 16 17 and _____

EXISTING SURVEYS

Original Government Survey

Year surveyed 1875
Original monument Wood post
(Wood post, stone, pile of stones, pipe, etc.)

Bearing Trees

Species Maple Fir
Diameter 8" 6"
Bearing S13°W S85°E
Distance 10.56 15.89

Subsequent Corner Restoration

Year surveyed _____ By _____
Where filed or recorded _____
Monument _____
(Original, concrete post, iron rod, etc.)

Bearing Trees, Reference Objects

Species _____
Diameter _____
Bearing _____
Distance _____

Original Evidence Found

Year of search 1968 By RH McDonald
Monument found NONE

Original Bearing Trees Found

Species _____
Diameter _____
Bearing _____
Distance _____

Evidence of Subsequent Corner Restoration Found

Year of search _____ By _____

Bearing Trees, Reference Objects

Species _____
Diameter _____
Bearing _____
Distance _____

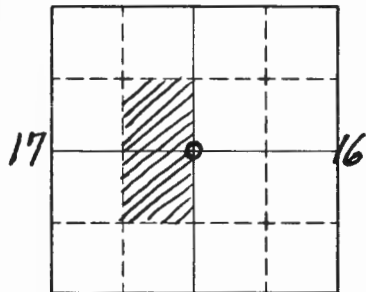

Sketch

○ Corner ▨ F.S. Land

Relation of Evidence to Record Features Along Section Lines

Section line to sections _____
 Object _____
 Record distance _____
 Measured distance _____

Other Evidence

Describe evidence of use and occupation such as roads, fences, clearings, timber cutting lines, plantations, etc.. Cite source of testimony if any. State Forest Service
has sheared this area and has destroyed corners
Shearing has been done several hundred feet
over on FS land.

At time of search:

1. Did you have the record description?

Yes No _____

2. How was search area located?

Pacing, chaining, photos, maps,
 etc. _____

3. Man hours spent in search 1

4. Do you think additional search might
 recover evidence? Yes _____ No

5. Signature [Handwritten Signature]

Perpetuation Record

Monument and accessories established. Include brief description of area. _____

Certified corner restoration certificate prepared: Yes _____ No _____
 Filed in county records at _____ Date _____ County Document No. _____
 Identified on aerial photo No. _____ Which is filed at _____

Index No. L-21
(Alphabetical - Numerical)

LAND CORNER RECORD
(RECTANGULAR SURVEYS)

R9-7150-4 (Rev. 6/13/67)
GPO 806-924

T. 149 N R. 25 W 5th Mer. N.F. Chippewa County Itasca State Minn.
Quarter Corner common to sections 13 14 and _____

EXISTING SURVEYS

Original Government Survey

Year surveyed 1875
Original monument Wood post
(Wood post, stone, pile of stones, pipe, etc.)

Bearing Trees

Species W. Birch Spruce
Diameter 8" 8"
Bearing N72°E N29°
Distance 5.58 90

Subsequent Corner Restoration

Year surveyed _____ By _____
Where filed or recorded _____
Monument _____
(Original, concrete post, iron rod, etc.)

Bearing Trees, Reference Objects

Species _____
Diameter _____
Bearing _____
Distance _____

Original Evidence Found

Year of search 1969 By R.H. McDonald
Monument found _____

Original Bearing Trees Found

Species _____
Diameter _____
Bearing _____
Distance _____

Evidence of Subsequent Corner Restoration Found

Year of search _____ By _____

Bearing Trees, Reference Objects

Species _____
Diameter _____
Bearing _____
Distance _____

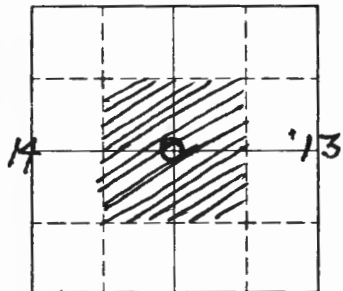

Sketch

○ Corner ▨ F.S. Land

Relation of Evidence to Record Features Along Section Lines

Section line to sections _____
 Object _____
 Record distance _____
 Measured distance _____

Other Evidence

Describe evidence of use and occupation such as roads, fences, clearings, timber cutting lines, plantations, etc.. Cite source of testimony if any. _____

At time of search:

1. Did you have the record description?

Yes No _____

2. How was search area located?

Pacing, chaining, photos, maps,
 etc. _____

3. Man hours spent in search _____

4. Do you think additional search might
 recover evidence? Yes _____ No

5. Signature

R.H.M. Donald

Perpetuation Record

Monument and accessories established. Include brief description of area. _____

Certified corner restoration certificate prepared: Yes _____ No _____

Filed in county records at _____ Date _____ County Document No. _____

Identified on aerial photo No. _____ Which is filed at _____

T. 149 N. R. 25 W. 5 Mer. N.F. Chippewa County Itasca State Minn.
Mc. North Shore #4 Corner common to sections 14 15 and Lac-A-Roy

EXISTING SURVEYS

Original Government Survey

Year surveyed 1875 GLO

Original monument Post
(Wood post, stake, pile of stones, pipe, etc.)

Bearing Trees

Species	<u>D. Pine</u>	<u>Y. Pine</u>
Diameter	<u>2 1/2"</u>	<u>8"</u>
Bearing	<u>N13E</u>	<u>N23W</u>
Distance	<u>56 lbs</u>	<u>28 lbs</u>

Original Evidence Found

Year of search _____ By _____

Monument found _____

Original Bearing Trees Found

Species	_____	_____
Diameter	_____	_____
Bearing	_____	_____
Distance	_____	_____

Subsequent Corner Restoration

Year surveyed 1977 By Roy Olesen & Krauss

Where filed or recorded _____

Monument Set 2" x 4" x 5' driftwood post in place
(Original, concrete post, iron rod, etc.)
of found post top in sand of Lac-A-Roy
28 lbs

Evidence of Subsequent Corner Restoration Found

Year of search 1987 By Kesenko & White

Set 3/4" x 3/8" alum rod monument
flush with ground in place of 2x4x5'
post

Bearing Trees, Reference Objects

Species	_____
Diameter	_____
Bearing	_____
Distance	_____

Bearing Trees, Reference Objects

<u>W Birch</u>	<u>Birch</u>	<u>W Birch</u>	<u>Sign Post</u>
<u>6.2"</u>	<u>8.5"</u>	<u>6.8"</u>	<u>1'5"</u>
<u>N13E</u>	<u>N43 1/2 W</u>	<u>N71 1/2 W</u>	
<u>45.60'</u>	<u>24.70'</u>	<u>34.80'</u>	

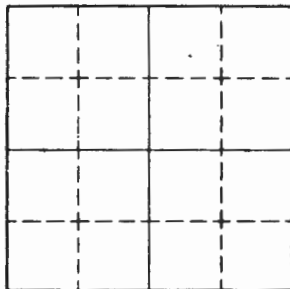

Sketch

Corner F.S. Land

Relation of Evidence to Record Features Along Section Lines

Section line to sections _____

Object _____

Record distance _____

Measured distance _____

Other Evidence

Describe evidence of use and occupation such as roads, fences, clearings, timber cutting lines, plantations, etc.. Cite source of testimony if any.

At time of search:

1. Did you have the record description?
Yes _____ No _____

2. How was search area located?
Pacing, chaining, photos, maps,
etc. _____

3. Man hours spent in search _____

4. Do you think additional search might
recover evidence? _____

Perpetuation Record

Monument and accessories established. Include brief description of area.

monument is 3.0 feet into line

CERTIFICATE FILED

Restoration certificate prepared: Keith White Yes _____ No _____

Filed in _____ records at St. Johns Date 12/4/82 County Document No. 355065

Identified on aerial photo No. _____ Which is filed at _____

5. Signature _____

Index No. L.M-17
(Alphabetical - Numerical)LAND CORNER RECORD
(RECTANGULAR SURVEYS)

R9-7150-4 (Rev. 6/13/67)

GPO 808-924

T. 149 N R. 25 W 5th Mer. N.F. Chippewa County Tasca State MINN.
M.C. Corner common to sections 14 15 and _____

EXISTING SURVEYS

Original Government Survey

Year surveyed 1875
Original monument Wood post
(Wood post, stone, pile of stones, pipe, etc.)

Bearing Trees

Species Norway Pine Norway Pine
Diameter 24" 8"
Bearing N13°E N23°W
Distance 36.96' 18.48'

Subsequent Corner Restoration

Year surveyed _____ By _____
Where filed or recorded _____
Monument _____
(Original, concrete post, iron rod, etc.)

Bearing Trees, Reference Objects

Species _____
Diameter _____
Bearing _____
Distance _____

Original Evidence Found

Year of search 1967 By R.H. McDonald
Monument found _____

Original Bearing Trees Found

Species _____
Diameter _____
Bearing _____
Distance _____

Evidence of Subsequent Corner Restoration Found

Year of search _____ By _____

Bearing Trees, Reference Objects

Species _____
Diameter _____
Bearing _____
Distance _____

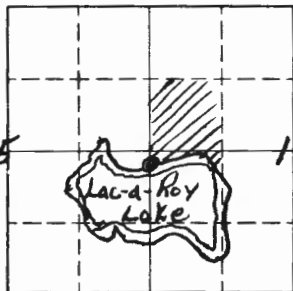

Sketch

○ Corner ▨ F.S. Land

Relation of Evidence to Record Features Along Section Lines

Section line to sections 14-15
 Object Quarter Coy
 Record distance 10.1 chains
 Measured distance _____

Other Evidence

Describe evidence of use and occupation such as roads, fences, clearings, timber cutting lines, plantations, etc.. Cite source of testimony if any.

At time of search:

1. Did you have the record description?

Yes No _____

2. How was search area located?

Pacing, chaining, photos, maps,
 etc. _____

3. Man hours spent in search 2

4. Do you think additional search might
 recover evidence? Yes _____ No

Perpetuation Record

Monument and accessories established. Include brief description of area.

Certified corner restoration certificate prepared: Yes _____ No _____

Filed in county records at _____ Date _____ County Document No. _____

Identified on aerial photo No. _____ Which is filed at _____

5. Signature Robert W. Donald

T. 149 N R. 25 W 5th Mer. N.F. Chippewa County Itasca State Minnesota
South 1/16 Corner common to sections 18 & 13 and _____

EXISTING SURVEYS

Original Government Survey

Year surveyed _____

Original monument _____
(Wood post, stone, pile of stones, pipe, etc.)

Bearing Trees

Species _____

Diameter _____

Bearing _____

Distance _____

Subsequent Corner Restoration

Year surveyed _____

By _____

Where filed or recorded _____

Monument _____
(Original, concrete post, iron rod, etc.)

Bearing Trees, Reference Objects

Species _____

Diameter _____

Bearing _____

Distance _____

Original Evidence Found

Year of search _____

By _____

Monument found _____

Original Bearing Trees Found

Species _____

Diameter _____

Bearing _____

Distance _____

Evidence of Subsequent Corner Restoration Found

Year of search _____

By _____

Bearing Trees, Reference Objects

Species _____

Diameter _____

Bearing _____

Distance _____

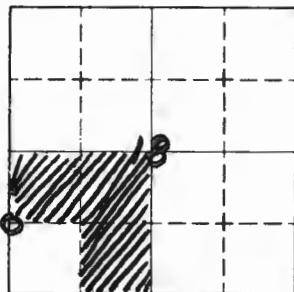

Sketch

○ Corner ▨ F.S. Land

Relation of Evidence to Record Features Along Section Lines

Section line to sections _____
 Object _____
 Record distance _____
 Measured distance _____

Other Evidence

Describe evidence of use and occupation such as roads, fences, clearings, timber cutting lines, plantations, etc.. Cite source of testimony if any.

At time of search:

1. Did you have the record description?

Yes _____ No _____

2. How was search area located?

Pacing, chaining, photos, maps,
 etc. _____

3. Man hours spent in search _____

4. Do you think additional search might
 recover evidence? Yes _____ No _____

5. Signature _____

Perpetuation Record

Monument and accessories established. Include brief description of area.

*I put up F.S. L.P. on North Side of 12" Aspen
 marking approx 1/16 cor.
 blue line running South + East of cor*

*1-75
 Ronald Olson*

Certified corner restoration certificate prepared: Yes _____ No _____

Filed in county records at _____ Date _____ County Document No. _____

Identified on aerial photo No. _____ Which is filed at _____

T. 149 N R. 25 W 5th Mer. N.F. Chippewa County Flasch State Minnesota
S.W. 1/16 Corner common to sections 18 and _____

EXISTING SURVEYS

Original Government Survey	Original Evidence Found
Year surveyed _____	Year of search _____ By _____
Original monument _____ <small>(Wood post, stone, pile of stones, pipe, etc.)</small>	Monument found _____
Bearing Trees	Original Bearing Trees Found
Species _____	Species _____
Diameter _____	Diameter _____
Bearing _____	Bearing _____
Distance _____	Distance _____
Subsequent Corner Restoration	Evidence of Subsequent Corner Restoration Found
Year surveyed _____ By _____	Year of search _____ By _____
Where filed or recorded _____	_____
Monument _____ <small>(Original, concrete post, iron rod, etc.)</small>	_____
_____	_____
_____	_____
Bearing Trees, Reference Objects	Bearing Trees, Reference Objects
Species _____	_____
Diameter _____	_____
Bearing _____	_____
Distance _____	_____

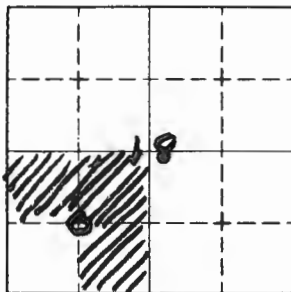

Sketch

○ Corner ▨ F.S. Land

Relation of Evidence to Record Features Along Section Lines

Section line to sections _____
 Object _____
 Record distance _____
 Measured distance _____

Other Evidence

Describe evidence of use and occupation such as roads, fences, clearings, timber cutting lines, plantations, etc.. Cite source of testimony if any.

At time of search:

1. Did you have the record description?

Yes _____ No _____

2. How was search area located?

Pacing, chaining, photos, maps,
 etc. _____

3. Man hours spent in search _____

4. Do you think additional search might
 recover evidence? Yes _____ No _____

5. Signature _____

Perpetuation Record

Monument and accessories established. Include brief description of area.

I put up F.S. LP on the North Side of 10" Aspen marking Approx 11/6 cor blue line running South & west of cor

*1-75
 Ronald Olson*

Certified corner restoration certificate prepared: Yes _____ No _____

Filed in county records at _____ Date _____ County Document No. _____

Identified on aerial photo No. _____ Which is filed at _____

T. 149 N R. 25 W 5th Mer. N.F. Chippewa County Itasca State Minnesota
S.E. 1/16 Corner common to sections 18 and _____

EXISTING SURVEYS

Original Government Survey	Original Evidence Found
Year surveyed _____	Year of search _____ By _____
Original monument _____ <small>(Wood post, stone, pile of stones, pipe, etc.)</small>	Monument found _____
Bearing Trees	Original Bearing Trees Found
Species _____	Species _____
Diameter _____	Diameter _____
Bearing _____	Bearing _____
Distance _____	Distance _____
Subsequent Corner Restoration	Evidence of Subsequent Corner Restoration Found
Year surveyed _____ By _____	Year of search _____ By _____
Where filed or recorded _____	_____
Monument _____ <small>(Original, concrete post, iron rod, etc.)</small>	_____
_____	_____
_____	_____
Bearing Trees, Reference Objects	Bearing Trees, Reference Objects
Species _____	_____
Diameter _____	_____
Bearing _____	_____
Distance _____	_____

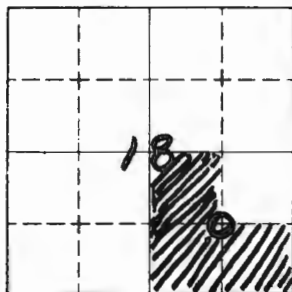

Sketch

○ Corner ▨ F.S. Land

Relation of Evidence to Record Features Along Section Lines

Section line to sections _____
 Object _____
 Record distance _____
 Measured distance _____

Other Evidence

Describe evidence of use and occupation such as roads, fences, clearings, timber cutting lines, plantations, etc.. Cite source of testimony if any. _____

At time of search:

1. Did you have the record description?

Yes _____ No _____

2. How was search area located?

Pacing, chaining, photos, maps, etc. _____

3. Man hours spent in search _____

4. Do you think additional search might recover evidence? Yes _____ No _____

5. Signature _____

Perpetuation Record

Monument and accessories established. Include brief description of area.

I put up F.S.L.P. on the South side of 6" Balsam marking Approx Cor. blue line running North & East of cor

*1-75
 Ronald Olson*

Certified corner restoration certificate prepared: Yes _____ No _____

Filed in county records at _____ Date _____ County Document No. _____

Identified on aerial photo No. _____ Which is filed at _____

Index No. M-5
(Alphabetical - Numerical)

LAND CORNER RECORD
(RECTANGULAR SURVEYS)

R9-7150-4 (Rev. 6/13/67)
GPO 502-127

T. 149 N R. 25 W 5th Mer. N.F. Chippewa County Itasca State Minnesota
5/1/16 Corner common to sections 18 & 17 and _____

EXISTING SURVEYS

Original Government Survey

Year surveyed _____

Original monument _____
(Wood post, stone, pile of stones, pipe, etc.)

Bearing Trees

Species _____

Diameter _____

Bearing _____

Distance _____

Original Evidence Found

Year of search _____ By _____

Monument found _____

Original Bearing Trees Found

Species _____

Diameter _____

Bearing _____

Distance _____

Subsequent Corner Restoration

Year surveyed _____ By _____

Where filed or recorded _____

Monument _____
(Original, concrete post, iron rod, etc.)

Evidence of Subsequent Corner Restoration Found

Year of search _____ By _____

Bearing Trees, Reference Objects

Species _____

Diameter _____

Bearing _____

Distance _____

Bearing Trees, Reference Objects

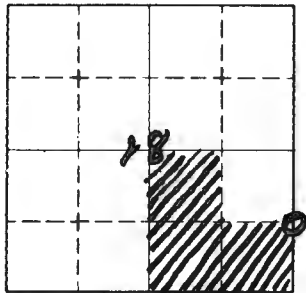

Sketch

○ Corner ▨ F.S. Land

Relation of Evidence to Record Features Along Section Lines

Section line to sections _____
 Object _____
 Record distance _____
 Measured distance _____

Other Evidence

Describe evidence of use and occupation such as roads, fences, clearings, timber cutting lines, plantations, etc.. Cite source of testimony if any.

At time of search:

1. Did you have the record description?

Yes _____ No _____

2. How was search area located?

Pacing, chaining, photos, maps,
 etc. _____

3. Mon hours spent in search _____

4. Do you think additional search might
 recover evidence? Yes _____ No _____

5. Signature _____

Perpetuation Record

Monument and accessories established. Include brief description of area.

*I put up F.S. L.P. on the North Side of
 of 4" Willow Clump, marking approx. Corn.
 blue line running west of Corn.*

*1-25
 Road Clean*

Certified corner restoration certificate prepared: Yes _____ No _____

Filed in county records at _____ Date _____ County Document No. _____

Identified on aerial photo No. _____ Which is filed at _____

Index No. M-N-13
(Alphabetical-Numerical)

LAND CORNER RECORD
(RECTANGULAR SURVEYS)

R9-7150-4 (Rev. 6/13/67)
GPO 805-924

T. 149N R. 25W Mer. N.F. Chippewa County Itasca State MINN.
W.C.M.C. Corner common to sections 15 and 16

EXISTING SURVEYS

Original Government Survey

Year surveyed 1875
Original monument Wood post
(Wood post, stone, pile of stones, pipe, etc.)

Bearing Trees

Species Norway Pine
Diameter 14"
Bearing N2°W
Distance 25.08'

Subsequent Corner Restoration

Year surveyed _____ By _____
Where filed or recorded _____
Monument _____
(Original, concrete post, iron rod, etc.)

Bearing Trees, Reference Objects

Species _____
Diameter _____
Bearing _____
Distance _____

Original Evidence Found

Year of search 1968 By R.H. McDonald
Monument found _____

Original Bearing Trees Found

Species N. Pine Stump
Diameter 14"
Bearing N2°W
Distance 25.08'

Evidence of Subsequent Corner Restoration Found

Year of search _____ By _____
SEE CORNER AFFIDAVIT

Bearing Trees, Reference Objects

Species _____
Diameter _____
Bearing _____
Distance _____

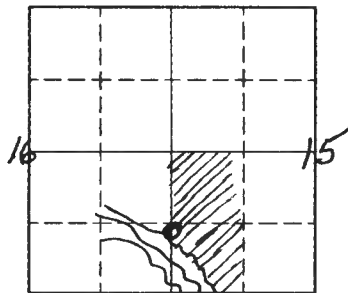

Sketch

○ Corner ▨ F.S. Land

Relation of Evidence to Record Features Along Section Lines

Section line to sections _____

Object _____

Record distance _____

Measured distance _____

Other Evidence

Describe evidence of use and occupation such as roads, fences, clearings, timber cutting lines, plantations, etc. Cite source of testimony if any.

Point for orig. M.C. falls in lake so I set a witness corner 30.0' North of this point.

At time of search:

1. Did you have the record description?

Yes No _____

2. How was search area located?

Pacing, chaining, photos, maps, etc. _____

3. Man hours spent in search _____

4. Do you think additional search might recover evidence? Yes _____ No _____

5. Signature

W. M. Donald

Perpetuation Record

Monument and accessories established. Include brief description of area.

Set a 2" ϕ steel pipe with brass cap MKD T149NR25W
 Oak 11" N15°W 66.5' MKD W.C. M.C. S16 BT
 Birch 9" S88 $\frac{1}{2}$ °E 13.3' MKD W.C. M.C. S15 BT
 Steel sign post w/ F.S. signs 54-? & 54-4 attached set North 5.0'

516 | 515
 W.C. M.C.
 1968
 RLS NO 6807

Certified corner restoration certificate prepared:

Yes No _____

Filed in county records at _____ Date _____ County Document No. _____

Identified on aerial photo No. _____ Which is filed at _____

Index No. M N-17
(Alphabetical - Numerical)LAND CORNER RECORD
(RECTANGULAR SURVEYS)R9-7150-4 (Rev. 6/15/67)
GPO 805-924T. 149N R. 25W Mer. N.F. Chippewa County Itasca State MINN.
M.C. Corner common to sections 14 15 and _____

EXISTING SURVEYS

Original Government Survey

Year surveyed 1875
Original monument Wood post
(Wood post, stone, pile, stones, pipe, etc.)

Bearing Trees

Species Aspen Ash
Diameter 6" 6"
Bearing S14°W S37°E
Distance 7.92 2612'

Subsequent Corner Restoration

Year surveyed _____ By _____
Where filed or recorded _____
Monument _____
(Original, concrete post, iron rod, etc.)

Bearing Trees, Reference Objects

Species _____
Diameter _____
Bearing _____
Distance _____

Original Evidence Found

Year of search 1967 By R.H. McDonald
Monument found None

Original Bearing Trees Found

Species _____
Diameter _____
Bearing _____
Distance _____

Evidence of Subsequent Corner Restoration Found

Year of search _____ By _____

Bearing Trees, Reference Objects

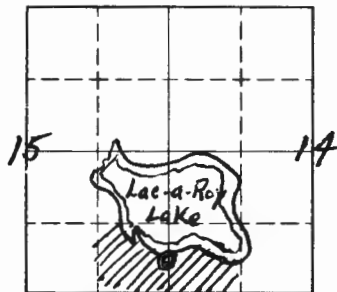

Sketch

○ Corner ▨ F.S. Land

At time of search:

1. Did you have the record description?

Yes No

2. How was search area located?

Pacing, chaining, photos, maps,
etc.

3. Man hours spent in search 2

4. Do you think additional search might
recover evidence? Yes No

5. Signature

Ronald

Relation of Evidence to Record Features Along Section Lines

Section line to sections _____
Object _____
Record distance _____
Measured distance _____

Other Evidence

Describe evidence of use and occupation such as roads, fences, clearings, timber cutting lines, plantations, etc.. Cite source of testimony if any.

Perpetuation Record

Monument and accessories established. Include brief description of area.

Certified corner restoration certificate prepared: Yes No

Filed in county records at _____ Date _____ County Document No. _____

Identified on aerial photo No. _____ Which is filed at _____

Index No. N-1
(Alphabetical - Numerical)

LAND CORNER RECORD
(RECTANGULAR SURVEYS)

R9-7150-4 (Rev. 6/13/67)
 GPO 806-924

T. 149N R. 25-26W 5th Mer. N.F. Chippewa County Itasca State MINN.
SECTION Corner common to sections 18, 19, 13 and 24

EXISTING SURVEYS

Original Government Survey

Year surveyed 1875
 Original monument wood post
(Wood post, stone, pile of stones, pipe, etc.)

Bearing Trees

Species	Tamarack	Tamarack	Cedar
Diameter	7"	10"	4"
Bearing	S 6° W	N 13° W	N 17° E
Distance	8.58'	13.86'	9.24'

Subsequent Corner Restoration

Year surveyed _____ By _____
 Where filed or recorded _____
 Monument _____
(Original, concrete post, iron rod, etc.)

Bearing Trees, Reference Objects

Species	_____	_____	_____
Diameter	_____	_____	_____
Bearing	_____	_____	_____
Distance	_____	_____	_____

Original Evidence Found

Year of search 1969 By R.H. McDonald
 Monument found wood post scribed

Original Bearing Trees Found

Species	Tam. Wood Fall	Tam. Stump	Decayed Cedar stp
Diameter	_____	_____	_____
Bearing	S 6° W	N 21° W	N 17° E
Distance	8.58'	18.4'	11.0'

Evidence of Subsequent Corner Restoration Found

Year of search _____ By _____
SEE CORNER AFFIDAVIT

Bearing Trees, Reference Objects

Species	_____	_____	_____
Diameter	_____	_____	_____
Bearing	_____	_____	_____
Distance	_____	_____	_____

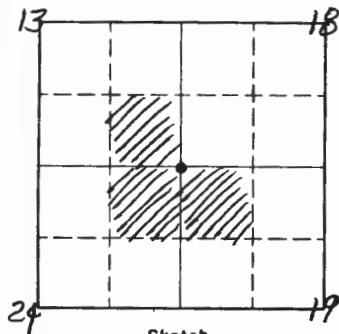

Sketch

○ Corner ▨ F.S. Land

Relation of Evidence to Record Features Along Section Lines

Section line to sections _____
 Object _____
 Record distance _____
 Measured distance _____

Other Evidence

Describe evidence of use and occupation such as roads, fences, clearings, timber cutting lines, plantations, etc. Cite source of testimony if any.

F.S. location poster on 9" Cedar N38°W 7.0'
 date 1935

At time of search:

1. Did you have the record description?

Yes No _____

2. How was search area located?

Pacing, chaining, photos, maps,
 etc. _____

3. Man hours spent in search _____

4. Do you think additional search might
 recover evidence? Yes _____ No _____

5. Signature

Sam Donald

Perpetuation Record

Monument and accessories established. Include brief description of area.

Set a 2" ϕ steel pipe w/ brass cap MKD T149N
 Cedar 5" N60°E 23.5' MKD S 18 BT R26W R25W
 Cedar 8" S20½°E 6.3' MKD S 19 BT 513 | 518
 Cedar 8" S31°W 11.0' MKD S 24 BT 524 | 519
 Cedar 9" N32°W 7.2' MKD S 13 BT 1969
 Steel sign post w/ F.S. signs 54-2 RLS NO 6807
 § 54-4 set East 5.0'

Certified corner restoration certificate prepared:

Yes No _____

Filed in county records at _____ Date _____ County Document No. _____

Identified on aerial photo No. _____ Which is filed at _____

Index No. N-3
(Alphabetical - Numerical)LAND CORNER RECORD
(RECTANGULAR SURVEYS)R9-7150-4 (Rev. 6/13/67)
GPO 806-924T. 149 N R. 25 W
QuarterMer. N.F. 5th Chippewa County Itasca State MINN.
Corner common to sections 18, 19, and _____

EXISTING SURVEYS

Original Government Survey

Year surveyed 1875
Original monument Wood post
(Wood post, stone, pile of stakes, pipe, etc.)

Bearing Trees

Species White Birch White Birch
Diameter 8" 10"
Bearing S 3° E North
Distance 7.26' 15.18'

Subsequent Corner Restoration

Year surveyed _____ By _____
Where filed or recorded _____
Monument _____
(Original, concrete post, iron rod, etc.)

Bearing Trees, Reference Objects

Species _____
Diameter _____
Bearing _____
Distance _____

Original Evidence Found

Year of search 1969 By Robert McDonald
Monument found None.

Original Bearing Trees Found

Species _____
Diameter _____
Bearing _____
Distance _____

Evidence of Subsequent Corner Restoration Found

Year of search _____ By _____

Bearing Trees, Reference Objects

Species _____
Diameter _____
Bearing _____
Distance _____

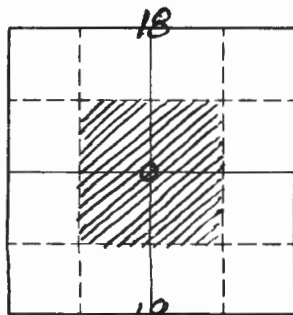

Sketch

○ Corner ▨ F.S. Land

Relation of Evidence to Record Features Along Section Lines

Section line to sections _____
 Object _____
 Record distance _____
 Measured distance _____

Other Evidence

Describe evidence of use and occupation such as roads, fences, clearings, timber cutting lines, plantations, etc.. Cite source of testimony if any. _____

Perpetuation Record

Monument and accessories established. Include brief description of prop.
Placed F.S. metal location poster on a 6" Birch at corner location.

Certified corner restoration certificate prepared: Yes _____ No _____
 Filled in county records at _____ Date _____ County Document No. _____
 Identified on aerial photo No. _____ Which is filed at _____

5. Signature

Arthur Donald

At time of search:

1. Did you have the record description?

Yes No _____

2. How was search area located?

Pacing, chaining, photos, mops, etc. _____

3. Man hours spent in search 2

4. Do you think additional search might recover evidence? Yes _____ No

Index No. N-5
(Alphabetical - Numerical)LAND CORNER RECORD
(RECTANGULAR SURVEYS)R9-7150-4 (Rev. 6/13/67)
GPO 808-924T. 149N R. 25W 5th Mer. N.F. Chippewa County Itasca State MINN.
Section Corner common to sections 17, 18, 19 and 20

EXISTING SURVEYS

Original Government Survey

Year surveyed 1875
Original monument Wood post
(Wood post, stone, pile of stones, pipe, etc.)

Bearing Trees

Species	<u>Spruce</u>	<u>Spruce</u>	<u>Spruce</u>	<u>Tamarack</u>
Diameter	<u>6"</u>	<u>8"</u>	<u>7"</u>	<u>8"</u>
Bearing	<u>S57°W</u>	<u>N16°W</u>	<u>N28°E</u>	<u>S50°E</u>
Distance	<u>17.16'</u>	<u>15.18'</u>	<u>7.92</u>	<u>31.68'</u>

Subsequent Corner Restoration

Year surveyed _____ By _____
Where filed or recorded _____
Monument _____
(Original, concrete post, iron rod, etc.)

Bearing Trees, Reference Objects

Species	_____	_____	_____
Diameter	_____	_____	_____
Bearing	_____	_____	_____
Distance	_____	_____	_____

Original Evidence Found

Year of search 1969 By Robert McDonald
Monument found Squared wood post

Original Bearing Trees Found

Species	_____	_____	_____
Diameter	_____	_____	_____
Bearing	_____	_____	_____
Distance	_____	_____	_____

Evidence of Subsequent Corner Restoration Found

Year of search _____ By _____

Bearing Trees, Reference Objects

Species	_____	_____	_____
Diameter	_____	_____	_____
Bearing	_____	_____	_____
Distance	_____	_____	_____

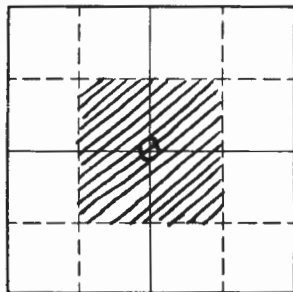

Sketch

○ Corner ▨ F.S. Land

Relation of Evidence to Record Features Along Section Lines

Section line to sections _____
 Object _____
 Record distance _____
 Measured distance _____

Other Evidence

Describe evidence of use and occupation such as roads, fences, clearings, timber cutting lines, plantations, etc.. Cite source of testimony if any. *Found a sq. post marking Cor. F.S. Form 874-9 date Dec. 9, 1935 by H. C. Norman - Placed F.S. metal location poster on 5" Cedar N23°E 21.3' (Now a fallen & decayed cedar w/ poster attached at record dist.) Cedar stp. 4" S12°E 12 1/2s (Now decayed stp S12°E.) Tam. stp. scribed BT N31°E 20 1/2s (Now decayed Tam. N31°E 13.2)*

At time of search:

1. Did you have the record description?

Yes No _____

2. How was search area located?

Pacing, chaining, photos, maps, etc. _____

3. Man hours spent in search 6

4. Do you think additional search might recover evidence? Yes _____ No

5. Signature *Ronald*

Perpetuation Record

Monument and accessories established. Include brief description of area.

I placed a F.S. metal location poster on a 11" Cedar N33°E 18.0 Ft.

Certified corner restoration certificate prepared: Yes _____ No _____

Filed in county records at _____ Date _____ County Document No. _____

Identified on aerial photo No. _____ Which is filed at _____

Index No. N-9
(Alphabetical & Numerical)LAND CORNER RECORD
(RECTANGULAR SURVEYS)R9-7150-4 (Rev. 6/13/67)
GPO 806-924T. 149 N R. 25 W Mer. N.F. Chippewa County Itasca State MINN.
SECTION Corner common to sections 16, 17, 20 and 21

EXISTING SURVEYS

Original Government Survey

Year surveyed 1875
Original monument Wood post
(Wood post, stone, pile of stones, pipe, etc.)

Bearing Trees

Species	Tamarack	Tamarack	Tamarack	Cedar
Diameter	12"	6"	14"	6"
Bearing	N67°W	S51°E	N59°E	S42°E
Distance	5.28'	9.9'	10.56'	9.24'

Subsequent Corner Restoration

Year surveyed _____ By _____
Where filed or recorded _____
Monument _____
(Original, concrete post, iron rod, etc.)

Bearing Trees, Reference Objects

Species	_____	_____	_____
Diameter	_____	_____	_____
Bearing	_____	_____	_____
Distance	_____	_____	_____

Original Evidence Found

Year of search 1967 By Robert McDonald
Monument found None

Original Bearing Trees Found

Species	_____	_____	_____	_____
Diameter	_____	_____	_____	_____
Bearing	_____	_____	_____	_____
Distance	_____	_____	_____	_____

Evidence of Subsequent Corner Restoration Found

Year of search _____ By _____

Bearing Trees, Reference Objects

Species	_____	_____	_____	_____
Diameter	_____	_____	_____	_____
Bearing	_____	_____	_____	_____
Distance	_____	_____	_____	_____

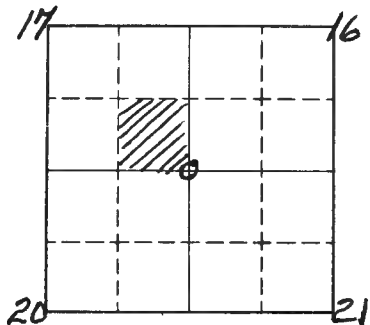

Sketch

○ Corner ▨ F.S. Land

Relation of Evidence to Record Features Along Section Lines

Section line to sections	<u>16-21</u>	<u>16-17</u>	_____	_____
Object	<u>Creek</u>	<u>Creek</u>	_____	_____
Record distance	<u>594'</u>	<u>264'</u>	_____	_____
Measured distance	<u>594'</u>	<u>264'</u>	_____	_____

Other Evidence

Describe evidence of use and occupation such as roads, fences, clearings, timber cutting lines, plantations, etc.. Cite source of testimony if any. _____

Perpetuation Record

Monument and accessories established. Include brief description of area. _____

Certified corner restoration certificate prepared: Yes _____ No _____

Filed in county records at _____ Date _____ County Document No. _____

Identified on aerial photo No. _____ Which is filed at _____

At time of search:

1. Did you have the record description?

Yes No _____

2. How was search area located?

Pacing, chaining, photos, maps,
etc. _____

3. Man hours spent in search 6

4. Do you think additional search might
recover evidence? Yes _____ No

5. Signature [Signature]

T. 149N R. 25W Mer. 5 N.F. Chippewa County Itasca State Minnesota
Meander Corner common to sections 16-21 and _____

EXISTING SURVEYS

Original Government Survey	Original Evidence Found								
Year surveyed _____ Original monument _____ <small>(Wood post, stone, pile of stones, pipe, etc.)</small>	Year of search <u>1966</u> By <u>Wm. H. Okerman</u> Monument found _____								
<p style="text-align: center;">Bearing Trees</p> Species <u>Cedar tree</u> Diameter _____ Bearing <u>N85°W</u> Distance <u>46 links</u>	<p style="text-align: center;">Original Bearing Trees Found</p> Species _____ Diameter _____ Bearing _____ Distance _____								
<p style="text-align: center;">Subsequent Corner Restoration</p>	<p style="text-align: center;">Evidence of Subsequent Corner Restoration Found</p>								
Year surveyed <u>1966</u> By <u>Okerman</u> Where filed or recorded _____ Monument <u>2" inside diameter, 5' long galvanized steel pipe filled with concrete & capped with 3" diameter bronze tablet</u> <small>(Original, concrete post, iron rod, etc.)</small>	Year of search _____ By _____ _____ _____ _____ _____								
<p style="text-align: center;">Bearing Trees, Reference Objects</p> <table border="0"> <tr> <td>Species <u>Birch</u></td> <td><u>Birch</u></td> </tr> <tr> <td>Diameter <u>7"</u></td> <td><u>6"</u></td> </tr> <tr> <td>Bearing <u>S74 W</u></td> <td><u>N72 W</u></td> </tr> <tr> <td>Distance <u>11.7'</u></td> <td><u>11.8'</u></td> </tr> </table>	Species <u>Birch</u>	<u>Birch</u>	Diameter <u>7"</u>	<u>6"</u>	Bearing <u>S74 W</u>	<u>N72 W</u>	Distance <u>11.7'</u>	<u>11.8'</u>	_____ _____ _____ _____ _____
Species <u>Birch</u>	<u>Birch</u>								
Diameter <u>7"</u>	<u>6"</u>								
Bearing <u>S74 W</u>	<u>N72 W</u>								
Distance <u>11.7'</u>	<u>11.8'</u>								

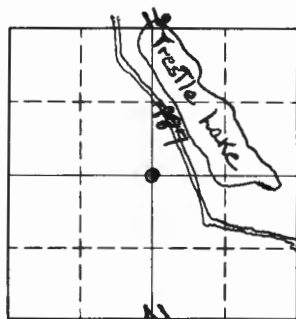

Sketch

○ Corner ▨ F.S. Land

Relation of Evidence to Record Features Along Section Lines

Section line to sections _____
 Object _____
 Record distance _____
 Measured distance _____

Other Evidence

Describe evidence of use and occupation such as roads, fences, clearings, timber cutting lines, plantations, etc.. Cite source of testimony if any. _____

At time of search:

1. Did you have the record description?

Yes _____ No _____

2. How was search area located?

Pacing, chaining, photos, maps,
 etc. _____

3. Man hours spent in search _____

4. Do you think additional search might
 recover evidence? Yes _____ No _____

5. Signature _____

Perpetuation Record

Monument and accessories established. Include brief description of area. _____

Certified corner restoration certificate prepared: Yes _____ No _____

Filed in county records at _____ Date _____ County Document No. _____

Identified on aerial photo No. _____ Which is filed at _____

Index No. N-12-13
(Alphabetical - Numerical)

LAND CORNER RECORD
(RECTANGULAR SURVEYS)

R9-7150-4 (Rev. 6/13/67)
GPO 806-924

T. 149 N R. 25 W Mer. N.F. Chippewa County Itasca State MINN.
Meander Corner common to sections 16 21 and _____

EXISTING SURVEYS

Original Government Survey

Year surveyed 1875
Original monument Post, wood
(Wood post, stone, pile of stones, pipe, etc.)

Bearing Trees

Species Cedar
Diameter 6
Bearing N85°W
Distance 30.36'

Subsequent Corner Restoration

Year surveyed _____ By _____
Where filed or recorded _____
Monument _____
(Original, concrete post, iron rod, etc.)

Bearing Trees, Reference Objects

Species _____
Diameter _____
Bearing _____
Distance _____

Original Evidence Found

Year of search 1966 By Bill Oxerman
Monument found _____

Original Bearing Trees Found

Species Cedar snag
Diameter _____
Bearing N85°W
Distance 30.36

Evidence of Subsequent Corner Restoration Found

Year of search _____ By _____
SEE CORNER AFFIDAVIT

Bearing Trees, Reference Objects

Species _____
Diameter _____
Bearing _____
Distance _____

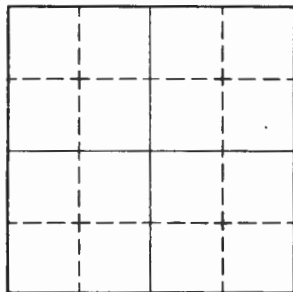

Sketch

○ Corner  F.S. Land

Relation of Evidence to Record Features Along Section Lines

Section line to sections _____

Object _____

Record distance _____

Measured distance _____

Other Evidence

Describe evidence of use and occupation such as roads, fences, clearings, timber cutting lines, plantations, etc.. Cite source of testimony if any. _____

At time of search:

1. Did you have the record description?

Yes _____ No _____

2. How was search area located?

Pacing, chaining, photos, maps, etc. _____

3. Man hours spent in search _____

4. Do you think additional search might recover evidence? Yes _____ No _____

5. Signature _____

Perpetuation Record

Monument and accessories established. Include brief description of area.

Set 2" ϕ , 5' long steel pipe w/ brass Cap MKD- T149NR256
S16 W.C. MC.

Birch 7" S74°W 11.7' MKD W.C. S21 BT S21

Birch 6" N72°W 11.8' MKD W.C. S16 BT 1966
RLS NO 6807

Witness Corner is set 58' west of point for original meander corner.

Certified corner restoration certificate prepared: Yes No _____

Filed in county records at _____ Date _____ County Document No. _____

Identified on aerial photo No. _____ Which is filed at _____

Index No. N-17
(Alphabetical - Numerical)LAND CORNER RECORD
(RECTANGULAR SURVEYS)R9-7 150-4 (Rev. 6/13/67)
GPO 808-924T. 149 N R. 25 W Mer. N.F. Chippewa County Itasca State MINN.
Section Corner common to sections 14, 15, 22 and 23

EXISTING SURVEYS

Original Government Survey

Year surveyed 1875
Original monument Wood post
(Wood post, stone, pile of stones, pipe, etc.)

Bearing Trees

Species Maple
Diameter 6"
Bearing N43°E
Distance 1.98'

Subsequent Corner Restoration

Year surveyed _____ By _____
Where filed or recorded _____
Monument _____
(Original, concrete post, iron rod, etc.)

Bearing Trees, Reference Objects

Species _____
Diameter _____
Bearing _____
Distance _____

Original Evidence Found

Year of search 1967 By R.H. McDonald
Monument found _____

Original Bearing Trees Found

Species Maple
Diameter 16"
Bearing N43°E
Distance 1.98'

Evidence of Subsequent Corner Restoration Found

Year of search _____ By _____
SEE CORNER AFFIDAVIT

Bearing Trees, Reference Objects

Species _____
Diameter _____
Bearing _____
Distance _____

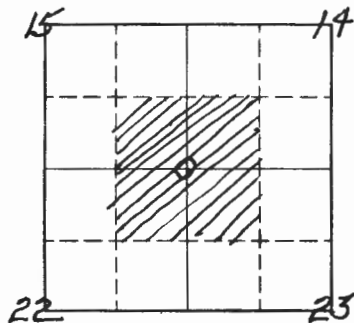

Sketch

○ Corner ▨ F.S. Land

Relation of Evidence to Record Features Along Section Lines

Section line to sections _____
 Object _____
 Record distance _____
 Measured distance _____

Other Evidence

Describe evidence of use and occupation such as roads, fences, clearings, timber cutting lines, plantations, etc.. Cite source of testimony if any. _____

At time of search:

1. Did you have the record description?

Yes No _____

2. How was search area located?

Pacing, chaining, photos, maps,
 etc. _____

3. Man hours spent in search _____

4. Do you think additional search might
 recover evidence? Yes _____ No _____

5. Signature *Robert H. McDonald*

Perpetuation Record

Monument and accessories established. Include brief description of area.
 Set a 2" ϕ steel pipe with brass cap MKD. T149N R25W
 Ash 5" S10°E 58.6' MKD S23 BT S15 | S14
 Maple 10" S65°W 62.5' MKD S22 BT S22 | S23
 Birch 5" N37°W 53.0' MKD S15 BT 1967
 Steel post with F.S. sign 54-4 RLS NO 6807
 set S77°E 7.0 feet.

Certified corner restoration certificate prepared: Yes No _____

Filed in county records at _____ Date _____ County Document No. _____

Identified on aerial photo No. _____ Which is filed at _____

Index No. N-17
(Alphabetical - Numerical)LAND CORNER RECORD
(RECTANGULAR SURVEYS)R9-7150-4 (Rev. 6/13/67)
GPO 802-127T. 149N R. 25W 5²P. Mer. N.F. Chippewa County Itasca State Minnesota
Section Corner common to sections 14 15 22 and 23

EXISTING SURVEYS

Original Government Survey

Year surveyed Oct 7 to 20, 1875 John P. Hinchelwood
Original monument 4in x 5in Maple Post
(Wood post, stone, pile of stones, pipe, etc.)

Bearing Trees

Species	<u>Maple</u>	<u>Maple</u>	<u>Maple</u>	<u>Aspen</u>
Diameter	<u>8in</u>	<u>10in</u>	<u>6in</u>	<u>20in</u>
Bearing	<u>N 25° W</u>	<u>S 42° E</u>	<u>N 43° E</u>	<u>S 46° W</u>
Distance	<u>6 lks</u>	<u>30 lks</u>	<u>3 lks</u>	<u>21 lks</u>
	<u>3.96 ft</u>	<u>19.80 ft</u>	<u>1.98 ft</u>	<u>13.86 ft</u>

Subsequent Corner Restoration

Year surveyed 1/30/36 By Gjelhaug, CCC
Where filed or recorded USFS 874
Monument Basswood post 40in above ground
(Original, concrete post, iron rod, etc.)

Bearing Trees, Reference Objects

Species	<u>W. Oak</u>		
Diameter	<u>14in</u>		
Bearing	<u>N 52° E</u>		
Distance	<u>25 lks</u>		

Original Evidence Found

Year of search 1/30/36 By J. A. Gjelhaug, CCC
Monument found none mentioned

Original Bearing Trees Found

Species	<u>Maple Stg</u>
Diameter	<u>12in</u>
Bearing	<u>S 70° E</u>
Distance	<u>15 lks</u>

Evidence of Subsequent Corner Restoration Found

Year of search 1967 By R. McDonald
See Book #1 Page 25

Bearing Trees, Reference Objects

Species			
Diameter			
Bearing			
Distance			

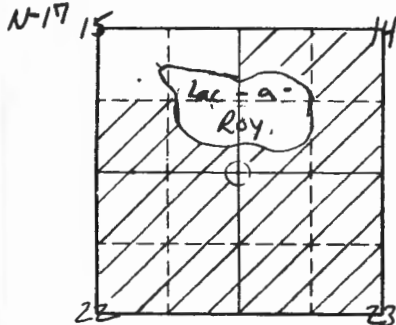

Sketch

○ Corner ▨ F.S. Land

Relation of Evidence to Record Features Along Section Lines

Section line to sections _____
 Object _____
 Record distance _____
 Measured distance _____

Other Evidence

Describe evidence of use and occupation such as roads, fences, clearings, timber cutting lines, plantations, etc.. Cite source of testimony if any. _____

At time of search:

1. Did you have the record description?

Yes X No _____

2. How was search area located?

Pacing, chaining, photos, maps,
 etc. previous monumentation

3. Man hours spent in search 4

4. Do you think additional search might recover evidence? Yes _____ No X

5. Signature [Signature] RLS

Perpetuation Record

Monument and accessories established. Include brief description of area. ¹⁰⁻⁴⁻⁸²

See page 3 of book # 3 Brass Cap stamped T.149 N, R.25 W.

					5.15	5.14
<u>Birch Stamp</u>	<u>R. Maple</u>	<u>R. Maple</u>	<u>Ash</u>	<u>New R. Maple</u>	5.22	5.23
<u>7.8 in</u>	<u>18.5 in</u>	<u>9.9 in</u>	<u>6.5 in</u>	<u>4.3 in</u>		
<u>N 10° W</u>	<u>N 76° E</u>	<u>S 56 1/2° W</u>	<u>S 33 1/2° E</u>	<u>N 7° W</u>		
<u>47.17 ft</u>	<u>25.00 ft</u>	<u>40.36 ft</u>	<u>63.00 ft</u>	<u>38.50 ft</u>		

1982
 RLS No. 14697

Certified corner restoration certificate prepared: Yes X No _____

Filed in county records at _____ Date 12-14-82 County Document No. 355058

Identified on aerial photo No. _____ Which is filed at _____

Index No. N-19
(Alphabetical - Numerical)LAND CORNER RECORD
(RECTANGULAR SURVEYS)R9-7150-4 (Rev. 6/13/67)
GPO 808-924T. 149N R. 25W
Quarter5thMer. N.F. Chippewa County ItascaState MinnesotaCorner common to sections 14, 23, and _____

EXISTING SURVEYS

Original Government Survey

Year surveyed 1875Original monument wood post
(Wood post, stone, pile of stones, pipe, etc.)

Bearing Trees

Species White birch CedarDiameter 8" 6"Bearing S24°W N53°WDistance 5.94' 7.26'

Original Evidence Found

Year of search 1969 By RH McDonald

Monument found _____

Original Bearing Trees Found

Species _____

Diameter _____

Bearing _____

Distance _____

Subsequent Corner Restoration

Year surveyed _____ By _____

Where filed or recorded _____

Monument _____
(Original, concrete post, iron rod, etc.)

Bearing Trees, Reference Objects

Species _____

Diameter _____

Bearing _____

Distance _____

Evidence of Subsequent Corner Restoration Found

Year of search _____ By _____

Bearing Trees, Reference Objects

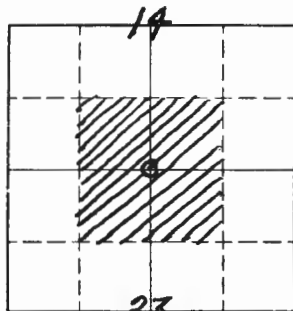

Sketch

○ Corner ▨ F.S. Land

Relation of Evidence to Record Features Along Section Lines

Section line to sections _____
 Object _____
 Record distance _____
 Measured distance _____

Other Evidence

Describe evidence of use and occupation such as roads, fences, clearings, timber cutting lines, plantations, etc.. Cite source of testimony if any. Chopped cast from Sec. corner and searched at record distance.

At time of search:

1. Did you have the record description?

Yes No _____

2. How was search area located?

Pacing, chaining, photos, maps, etc. _____

3. Man hours spent in search 3

4. Do you think additional search might recover evidence? Yes _____ No _____

5. Signature [Signature]

Perpetuation Record

Monument and accessories established. Include brief description of area. _____

Certified corner restoration certificate prepared: Yes _____ No _____

Filed in county records at _____ Date _____ County Document No. _____

Identified on aerial photo No. _____ Which is filed at _____

Index No. N-21
(Alphabetical - Numerical)

LAND CORNER RECORD
(RECTANGULAR SURVEYS)

RD-7150-4 (Rev. 6/13/67)
 GPO 808-924

T. 149N R. 25W 5th Mer. N.F. Chippewa County Itasca State Minn.
Section Corner common to sections 13, 14, 23 and 24

EXISTING SURVEYS

Original Government Survey

Year surveyed 1875
 Original monument Wood Post
(Wood post, stone, pile of stones, pipe, etc.)

Bearing Trees

Species	<u>Flr</u>	<u>White Pine</u>	<u>Tamarack</u>	<u>Spruce</u>
Diameter	<u>6"</u>	<u>7"</u>	<u>8"</u>	<u>10"</u>
Bearing	<u>N43°E</u>	<u>S54°E</u>	<u>S86°W</u>	<u>N21°W</u>
Distance	<u>4.62'</u>	<u>13.2'</u>	<u>14.52'</u>	<u>19.8'</u>

Subsequent Corner Restoration

Year surveyed _____ By _____
 Where filed or recorded _____
 Monument _____
(Original, concrete post, iron rod, etc.)

Bearing Trees, Reference Objects

Species _____
 Diameter _____
 Bearing _____
 Distance _____

Original Evidence Found

Year of search 1969 By R.H. McDonald
 Monument found None

Original Bearing Trees Found

Species _____
 Diameter _____
 Bearing _____
 Distance _____

Evidence of Subsequent Corner Restoration Found

Year of search _____ By _____

Bearing Trees, Reference Objects

Species _____
 Diameter _____
 Bearing _____
 Distance _____

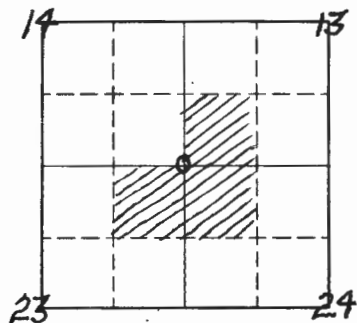

Sketch

○ Corner ▨ F.S. Land

Relation of Evidence to Record Features Along Section Lines

Section line to sections _____
 Object _____
 Record distance _____
 Measured distance _____

Other Evidence

Describe evidence of use and occupation such as roads, fences, clearings, timber cutting lines, plantations, etc.. Cite source of testimony if any. _____

At time of search:

1. Did you have the record description?

Yes No _____

2. How was search area located?

Pacing, chaining, photos, maps,
 etc. _____

3. Man hours spent in search 4

4. Do you think additional search might
 recover evidence? Yes No _____

Area is flooded now, may look
 when water is down.

5. Signature Robert M. Donald

Perpetuation Record

Monument and accessories established. Include brief description of area. _____

Certified corner restoration certificate prepared: Yes _____ No _____

Filed in county records at _____ Date _____ County Document No. _____

Identified on aerial photo No. _____ Which is filed at _____

Index No. N-23
(Alphabetical - Numerical)

LAND CORNER RECORD
(RECTANGULAR SURVEYS)

R9-7150-4 (Rev. 6/13/67)
GPO 805-924

T. 149 N R. 25 W 5th Mer. N.F. Chippewa County Itasca State MINN.
Quarter Corner common to sections 13 24 and _____

EXISTING SURVEYS

Original Government Survey

Year surveyed 1875
Original monument Wood post
(Wood post, stone, pile of stakes, pipe, etc.)

Bearing Trees

Species	Diameter	Bearing	Distance
<u>W. Birch</u>	<u>10"</u>	<u>N50°W</u>	<u>13.2</u>
<u>W. Birch</u>	<u>14"</u>	<u>S30°W</u>	<u>11.22</u>

Original Evidence Found

Year of search 1969 By R.H. McDonald
Monument found None

Original Bearing Trees Found

Species	Diameter	Bearing	Distance
_____	_____	_____	_____
_____	_____	_____	_____

Subsequent Corner Restoration

Year surveyed _____ By _____
Where filed or recorded _____
Monument _____
(Original, concrete post, iron rod, etc.)

Evidence of Subsequent Corner Restoration Found

Year of search _____ By _____

Bearing Trees, Reference Objects

Species	Diameter	Bearing	Distance
_____	_____	_____	_____
_____	_____	_____	_____

Bearing Trees, Reference Objects

Species	Diameter	Bearing	Distance
_____	_____	_____	_____
_____	_____	_____	_____

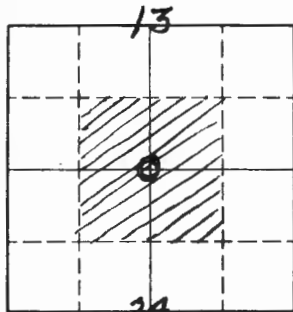

Sketch

○ Corner ▨ F.S. Land

Relation of Evidence to Record Features Along Section Lines

Section line to sections _____
 Object _____
 Record distance _____
 Measured distance _____

Other Evidence

Describe evidence of use and occupation such as roads, fences, clearings, timber cutting lines, plantations, etc.. Cite source of testimony if any. Found a cut out line up to lake (East-West) approx. 130' north of this is a blue paint line also E-W. No evidence of this corner was found.

At time of search:

1. Did you have the record description?

Yes No _____

2. How was search area located?

Pacing, chaining, photos, maps, etc. _____

3. Man hours spent in search 3

4. Do you think additional search might recover evidence? Yes _____ No

5. Signature John Donald

Perpetuation Record

Monument and accessories established. Include brief description of area. _____

Certified corner restoration certificate prepared: Yes _____ No _____

Filed in county records at _____ Date _____ County Document No. _____

Identified on aerial photo No. _____ Which is filed at _____

Index No. N-24
(Alphabetical - Numerical)

LAND CORNER RECORD
(RECTANGULAR SURVEYS)

R9-7150-4 (Rev. 6/13/67)
 GPO 802-127

T. 149 N R. 25 W 5th Mer. N.F. Chippewa County Itasca State Minnesota
East 1/16 Corner common to sections 13, 14, and _____

EXISTING SURVEYS

Original Government Survey

Year surveyed _____
 Original monument _____
(Wood post, stone, pile of stones, pipe, etc.)

Bearing Trees

Species _____
 Diameter _____
 Bearing _____
 Distance _____

Subsequent Corner Restoration

Year surveyed _____ By _____
 Where filed or recorded _____
 Monument _____
(Original, concrete post, iron rod, etc.)

Bearing Trees, Reference Objects

Species _____
 Diameter _____
 Bearing _____
 Distance _____

Original Evidence Found

Year of search _____ By _____
 Monument found _____

Original Bearing Trees Found

Species _____
 Diameter _____
 Bearing _____
 Distance _____

Evidence of Subsequent Corner Restoration Found

Year of search _____ By _____

Bearing Trees, Reference Objects

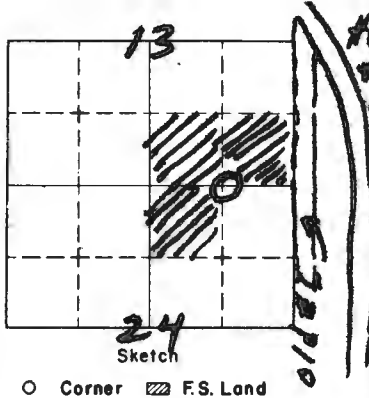

○ Corner ▨ F.S. Land

Sketch

Relation of Evidence to Record Features Along Section Lines

Section line to sections _____
 Object _____
 Record distance _____
 Measured distance _____

Other Evidence

Describe evidence of use and occupation such as roads, fences, clearings, timber cutting lines, plantations, etc.. Cite source of testimony if any. *I found a 10" Iron pipe with cap. which looks like an old pipe line valve. 1320' west of white post bisected to the Approx Syc cor. I believe this to be approx 1/16 cor. Cut out line going South to lake. I blue line East.*

*3/31/76
 small Olson*

Perpetuation Record

Monument and accessories established. Include brief description of area. _____

At time of search:

1. Did you have the record description?

Yes _____ No _____

2. How was search area located?

Pacing, chaining, photos, maps, etc. _____

3. Man hours spent in search _____

4. Do you think additional search might recover evidence? Yes _____ No _____

5. Signature _____

Certified corner restoration certificate prepared: Yes _____ No _____

Filed in county records at _____ Date _____ County Document No. _____

Identified on aerial photo No. _____ Which is filed at _____

Index No. N-25
(Alphabetical - Numerical)

LAND CORNER RECORD
(RECTANGULAR SURVEYS)

RD-7180-4 (Rev. 6/13/67)
GPO 802-127

T. 149 N R. 25 W
East Sec.

5th Mer. N.F. Chippewa County Itasca
Corner common to sections 12, 1, 24

State Minnesota
and _____

EXISTING SURVEYS

Original Government Survey

Year surveyed _____
Original monument _____
(Wood post, stone, pile of stones, pipe, etc.)

Bearing Trees

Species _____
Diameter _____
Bearing _____
Distance _____

Subsequent Corner Restoration

Year surveyed _____ By _____
Where filed or recorded _____
Monument _____
(Original, concrete post, iron rod, etc.)

Bearing Trees, Reference Objects

Species _____
Diameter _____
Bearing _____
Distance _____

Original Evidence Found

Year of search _____ By _____
Monument found _____

Original Bearing Trees Found

Species _____
Diameter _____
Bearing _____
Distance _____

Evidence of Subsequent Corner Restoration Found

Year of search _____ By _____

Bearing Trees, Reference Objects



○ Corner ▨ F.S. Land

Relation of Evidence to Record Features Along Section Lines

Section line to sections _____
 Object _____
 Record distance _____
 Measured distance _____

Other Evidence

Describe evidence of use and occupation such as roads, fences, clearings, timber cutting lines, plantations, etc.. Cite source of testimony if any. *Found a 8" white post on the West Edge of old #6 with a cut out blazed + a blue painted line going west from post. I believe this to be an approx 500 Corn*

8/21/96

R. Olson

Perpetuation Record

Monument and accessories established. Include brief description of area. _____

I painted New blue line west from this corner.

At time of search:

1. Did you have the record description?

Yes _____ No _____

2. How was search area located?

Pacing, chaining, photos, maps, etc. _____

3. Man hours spent in search _____

4. Do you think additional search might

recover evidence? Yes _____ No _____

5. Signature _____

Certified corner restoration certificate prepared: Yes _____ No _____

Filed in county records at _____ Date _____ County Document No. _____

Identified on aerial photo No. _____ Which is filed at _____

Index No. P-5
(Alphabetical - Numerical)

LAND CORNER RECORD
(RECTANGULAR SURVEYS)

RS-7 150-4 (Rev. 6/15/67)
 GPO 808-924

T. 149N R. 25W 5th Mer. N.F. Chippewa County Itasca State Minn.
Quarter Corner common to sections 19 20 and _____

EXISTING SURVEYS

Original Government Survey

Year surveyed 1875
 Original monument Wood post
(Wood post, stone, pile of stones, pipe, etc.)

Bearing Trees

Species White Birch White Birch
 Diameter 8" 8"
 Bearing N60°E N62°W
 Distance 3.3' 9.9'

Subsequent Corner Restoration

Year surveyed _____ By _____
 Where filed or recorded _____
 Monument _____
(Original, concrete post, iron rod, etc.)

Bearing Trees, Reference Objects

Species _____
 Diameter _____
 Bearing _____
 Distance _____

Original Evidence Found

Year of search 1969 By M.H. McDonald
 Monument found None

Original Bearing Trees Found

Species _____
 Diameter _____
 Bearing _____
 Distance _____

Evidence of Subsequent Corner Restoration Found

Year of search _____ By _____

Bearing Trees, Reference Objects

Species _____
 Diameter _____
 Bearing _____
 Distance _____

Relation of Evidence to Record Features Along Section Lines

Section line to sections _____
 Object _____
 Record distance _____
 Measured distance _____

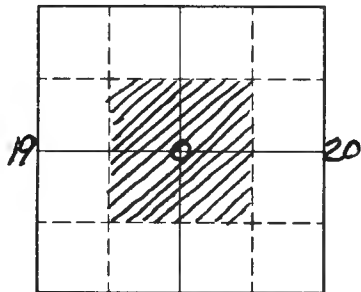

Sketch

○ Corner ▨ F.S. Land

Other Evidence

Describe evidence of use and occupation such as roads, fences, clearings, timber cutting lines, plantations, etc.. Cite source of testimony if any. *Area has been heavily burned - NO ORIGINAL EVIDENCE WAS FOUND.*

At time of search:

1. Did you have the record description?

Yes No _____

2. How was search area located?

Pacing, chaining, photos, maps, etc. _____

3. Man hours spent in search 1

4. Do you think additional search might recover evidence? Yes _____ No

5. Signature *[Handwritten Signature]*

Perpetuation Record

Monument and accessories established. Include brief description of area. _____

Certified corner restoration certificate prepared: Yes _____ No _____

Filed in county records at _____ Date _____ County Document No. _____

Identified on aerial photo No. _____ Which is filed at _____

Index No. P-9
(Alphabetical-Numerical)

LAND CORNER RECORD
(RECTANGULAR SURVEYS)

R9-7 150-4 (Rev. 6/13/67)
GPO 808-924

T. 149N R. 25W 5th Mer. N.F. Chippewa County Itasca State MINN.
Quarter Corner common to sections 20, 21, and _____

EXISTING SURVEYS

Original Government Survey

Year surveyed 1875
Original monument Wood post
(Wood post, stone, pile of stones, pipe, etc.)

Bearing Trees

Species Cedar Cedar _____
Diameter 10" 10" _____
Bearing S30°E West _____
Distance 13.2' 5.94' _____

Subsequent Corner Restoration

Year surveyed _____ By _____
Where filed or recorded _____
Monument _____
(Original, concrete post, iron rod, etc.)

Bearing Trees, Reference Objects

Species _____
Diameter _____
Bearing _____
Distance _____

Original Evidence Found

Year of search 1967 By Robert McDonald
Monument found None

Original Bearing Trees Found

Species _____
Diameter _____
Bearing _____
Distance _____

Evidence of Subsequent Corner Restoration Found

Year of search _____ By _____

Bearing Trees, Reference Objects

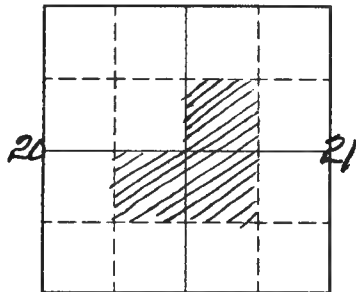

Sketch

○ Corner ▨ F.S. Land

Relation of Evidence to Record Features Along Section Lines

Section line to sections _____
 Object _____
 Record distance _____
 Measured distance _____

Other Evidence

Describe evidence of use and occupation such as roads, fences, clearings, timber cutting lines, plantations, etc.. Cite source of testimony if any. _____

At time of search:

1. Did you have the record description?

Yes No _____

2. How was search area located?

Pacing, chaining, photos, maps, etc. _____

3. Man hours spent in search 2

4. Do you think additional search might recover evidence? Yes _____ No

5. Signature Sam Donald

Perpetuation Record

Monument and accessories established. Include brief description of area. _____

Certified corner restoration certificate prepared: Yes _____ No _____

Filed in county records at _____ Date _____ County Document No. _____

Identified on aerial photo No. _____ Which is filed at _____

Index No. P-17
(Alphabetical - Numerical)LAND CORNER RECORD
(RECTANGULAR SURVEYS)R9-7 150-4 (Rev. 6/13/67)
GPO 808-924T. 149N R. 25W 5th Mer. N.F. Chippewa County Itasca State MINN.
Quarter Corner common to sections 22, 23, and _____

EXISTING SURVEYS

Original Government Survey

Year surveyed 1875
Original monument wood post
(Wood post, stone, pile of stones, pipe, etc.)~~As used~~ Bearing Trees
Species Linden White Birch
Diameter 12" 8"
Bearing East N85°W
Distance 9.9' 6.6'

Subsequent Corner Restoration

Year surveyed _____ By _____
Where filed or recorded _____
Monument _____
(Original, concrete post, iron rod, etc.)

Bearing Trees, Reference Objects

Species _____
Diameter _____
Bearing _____
Distance _____

Original Evidence Found

Year of search 1967 By R.H. McDonald
Monument found None

Original Bearing Trees Found

Species _____
Diameter _____
Bearing _____
Distance _____

Evidence of Subsequent Corner Restoration Found

Year of search _____ By _____

Bearing Trees, Reference Objects

Species _____
Diameter _____
Bearing _____
Distance _____

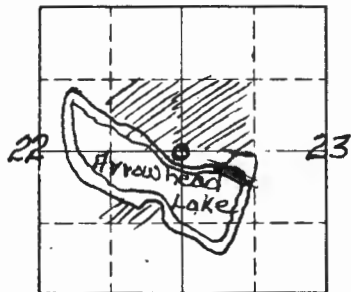

Sketch

O Corner ▨ F.S. Land

Relation of Evidence to Record Features Along Section Lines

Section line to sections _____
 Object _____
 Record distance _____
 Measured distance _____

Other Evidence

Describe evidence of use and occupation such as roads, fences, clearings, timber cutting lines, plantations, etc.. Cite source of testimony if any. I chained line from sec. cor. north and intersected Sec. Cor. South. At a record dist. of 236' North of arrowhead lake I found a decayed birch stump 6.6' west of line. Also found F.S. location poster dated 1956 40' ft. west of line - this states approx. corner.

Hung Tag on 8" line corner is South 6 1/2' c. Schultz 1976

Perpetuation Record

Monument and accessories established. Include brief description of area. _____

At time of search:

1. Did you have the record description?

Yes No _____

2. How was search area located?

Pacing, chaining, photos, maps, etc. _____

3. Man hours spent in search 3

4. Do you think additional search might recover evidence? Yes _____ No

5. Signature

Sam Donald

Certified corner restoration certificate prepared: Yes _____ No _____

Filed in county records at _____ Date _____ County Document No. _____

Identified on aerial photo No. _____ Which is filed at _____

Index No. P-22
(Alphabetical - Numerical)

LAND CORNER RECORD
(RECTANGULAR SURVEYS)

R9-7150-4 (Rev. 9/13/67)
GPO 802-127

T. 149 N R. 25 W 5th Mer. N.F. Chippewa County Itasca State Minnesota
West 1/16 Corner common to sections 24 and _____

EXISTING SURVEYS

Original Government Survey

Year surveyed _____
Original monument _____
(Wood post, stone, pile of stones, pipe, etc.)

Bearing Trees

Species _____
Diameter _____
Bearing _____
Distance _____

Subsequent Corner Restoration

Year surveyed _____ By _____
Where filed or recorded _____
Monument _____
(Original, concrete post, iron rod, etc.)

Bearing Trees, Reference Objects

Species _____
Diameter _____
Bearing _____
Distance _____

Original Evidence Found

Year of search _____ By _____
Monument found _____

Original Bearing Trees Found

Species _____
Diameter _____
Bearing _____
Distance _____

Evidence of Subsequent Corner Restoration Found

Year of search _____ By _____

Bearing Trees, Reference Objects

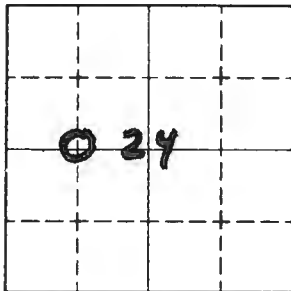

Sketch

○ Corner ▨ F.S. Land

Relation of Evidence to Record Features Along Section Lines

Section line to sections _____
 Object _____
 Record distance _____
 Measured distance _____

Other Evidence

Describe evidence of use and occupation such as roads, fences, clearings, timber cutting lines, plantations, etc.. Cite source of testimony if any. _____

At time of search:

1. Did you have the record description?

Yes _____ No _____

2. How was search area located?

Pacing, chaining, photos, maps,
 etc. _____

3. Man hours spent in search _____

4. Do you think additional search might
 recover evidence? Yes _____ No _____

5. Signature _____

Perpetuation Record

Monument and accessories established. Include brief description of area.

*I put up a F.S.L.P. on the North side of a
 7" Ash marking approx cor. 7 panted blue
 1m's East of cor.*

*4/14/75
 [Signature]*

Certified corner restoration certificate prepared: Yes _____ No _____

Filed in county records at _____ Date _____ County Document No. _____

Identified on aerial photo No. _____ Which is filed at _____

Index No. R-5
(Alphabetical - Numerical)

LAND CORNER RECORD
(RECTANGULAR SURVEYS)

R9-7 150-4 (Rev. 6/13/67)
GPO 805-924

T. 149 N. R. 25 W. Mer. N.F. 5th Chippewa County Itasca State MINN.
Section Corner common to sections 19, 20, 29 and 30

EXISTING SURVEYS

Original Government Survey

Year surveyed 1875
Original monument Wood Post
(Wood post, stone, pile of stones, pipe, etc.)

Bearing Trees

Species Tamarack
Diameter 7"
Bearing S51°W
Distance 25.08'

Subsequent Corner Restoration

Year surveyed _____ By _____
Where filed or recorded _____
Monument _____
(Original, concrete post, iron rod, etc.)

Bearing Trees, Reference Objects

Species _____
Diameter _____
Bearing _____
Distance _____

Original Evidence Found

Year of search 1969 By RH McDonald
Monument found old wood post marking
CORNER.

Original Bearing Trees Found

Species Tamarack stub
Diameter 10"
Bearing S51°W
Distance 25.08'

Evidence of Subsequent Corner Restoration Found

Year of search _____ By _____
SEE CORNER AFFIDAVIT

Bearing Trees, Reference Objects

Species _____
Diameter _____
Bearing _____
Distance _____

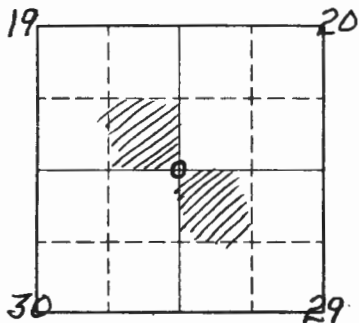

Sketch -

○ Corner ▨ F.S. Land

Relation of Evidence to Record Features Along Section Lines

Section line to sections _____
 Object _____
 Record distance _____
 Measured distance _____

Other Evidence

Describe evidence of use and occupation such as roads, fences, clearings, timber cutting lines, plantations, etc. Cite source of testimony if any.

Corner falls on south edge of old Tam. swamp

At time of search:

1. Did you have the record description?

Yes No _____

2. How was search area located?

Pacing, chaining, photos, maps, etc. _____

3. Man hours spent in search _____

4. Do you think additional search might recover evidence? Yes _____ No _____

5. Signature

[Handwritten Signature]

Perpetuation Record

Monument and accessories established. Include brief description of area.

Set a 2" ϕ steel pipe with brass cap MKD T149N R25W

S19 | S20

Cedar 11" S68°W 35.3' MKD S30 BT

S30 | S29

Cedar 10" S33°E 47.1' MKD S29 BT

1969

Cedar 12" N73½°E 54.5' MKD S20 BT

RLS NO 6807

Steel sign post with F.S. signs 54-2 & 54-4 attached set West 4.8'

Certified corner restoration certificate prepared:

Yes No _____

Filed in county records at _____ Date _____ County Document No. _____

Identified on aerial photo No. _____ Which is filed at _____

Index No. R-7
(Alphabetical - Numerical)LAND CORNER RECORD
(RECTANGULAR SURVEYS)R9-7 150-4 (Rev. 6/13/67)
GPO 805-924T. 149 R. 25 5th Mer. N.F. Chippewa County Itasca State MINN.
Quarter Corner common to sections 20, 29 and _____

EXISTING SURVEYS

Original Government Survey

Year surveyed 1875
Original monument Wood post
(Wood post, stone, pile of stones, pipe, etc.)

Bearing Trees

Species White Birch Fir _____
Diameter 10" 7" _____
Bearing S36°W N81°E _____
Distance 13.2' 3.3' _____

Subsequent Corner Restoration

Year surveyed _____ By _____
Where filed or recorded _____
Monument _____
(Original, concrete post, iron rod, etc.)

Bearing Trees, Reference Objects

Species _____
Diameter _____
Bearing _____
Distance _____

Original Evidence Found

Year of search 1967 By Robert McDonald
Monument found _____

Original Bearing Trees Found

Species _____
Diameter _____
Bearing _____
Distance _____

Evidence of Subsequent Corner Restoration Found

Year of search _____ By _____

Bearing Trees, Reference Objects

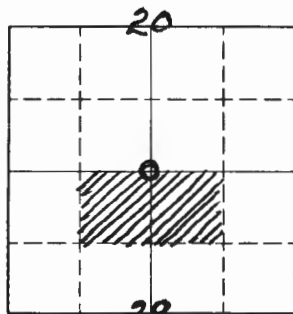

Sketch

○ Corner ▨ F.S. Land

Relation of Evidence to Record Features Along Section Lines

Section line to sections 20-29 20-29 _____
 Object Swamp Swamp _____
 Record distance 29.4 West of 470.6 East of Swamp _____
 Measured distance _____

Other Evidence

Describe evidence of use and occupation such as roads, fences, clearings, timber cutting lines, plantations, etc.. Cite source of testimony if any. _____

At time of search:

1. Did you have the record description?

Yes No _____

2. How was search area located?

Pacing, chaining, photos, maps,
 etc. _____

3. Man hours spent in search 1

4. Do you think additional search might
 recover evidence? Yes _____ No

5. Signature

Barth Donald

Perpetuation Record

Monument and accessories established. Include brief description of area. _____

Certified corner restoration certificate prepared: Yes _____ No _____

Filed in county records at _____ Date _____ County Document No. _____

Identified on aerial photo No. _____ Which is filed at _____

Index No. R-9
(Alphabetical - Numerical)

LAND CORNER RECORD
(RECTANGULAR SURVEYS)

R9-7150-4 (Rev. 6/13/67)
 GPO 806-924

T. 149 N. R. 25 W. Mer. N.F. Chippewa County Itasca State MINN.
Section Corner common to sections 20 21 28 and 29

EXISTING SURVEYS

Original Government Survey

Year surveyed 1875
 Original monument Wood post
(wood post, stone, sill of stones, pipe, etc.)

Bearing Trees

Species	White Pine	White Birch	Fir	Fir
Diameter	12"	14"	6"	6"
Bearing	S14°W	N22°E	S81°E	N47°W
Distance	10.56'	9.9'	13.2'	7.92'

Original Evidence Found

Year of search 1967 By Robert McDonald
 Monument found None

Original Bearing Trees Found

Species _____
 Diameter _____
 Bearing _____
 Distance _____

Subsequent Corner Restoration

Year surveyed _____ By _____
 Where filed or recorded _____
 Monument _____
(Original, concrete post, iron rod, etc.)

Evidence of Subsequent Corner Restoration Found

Year of search _____ By _____

Bearing Trees, Reference Objects

Species _____
 Diameter _____
 Bearing _____
 Distance _____

Bearing Trees, Reference Objects

Species _____
 Diameter _____
 Bearing _____
 Distance _____

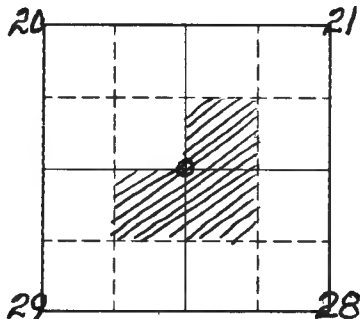

Sketch

○ Corner ▨ F.S. Land

Relation of Evidence to Record Features Along Section Lines

Section line to sections	<u>20-21</u>	<u>28-29</u>	<u>20-29</u>
Object	<u>Swamp</u>	<u>Pond</u>	<u>Swamp</u>
Record distance	<u>594'</u>	<u>565.6'</u>	<u>1601'</u>
Measured distance	<u>594'</u>	<u>565.6'</u>	<u>1601'</u>

Other Evidence

Describe evidence of use and occupation such as roads, fences, clearings, timber cutting lines, plantations, etc.. Cite source of testimony if any. old cut out line running East & West extends from swamp to corner.

At time of search:

1. Did you have the record description?

Yes No

2. How was search area located?

Pacing, chaining, photos, maps, etc.

3. Man hours spent in search 7

4. Do you think additional search might recover evidence? Yes No

5. Signature

[Handwritten Signature]

Perpetuation Record

Monument and accessories established. Include brief description of area.

Placed F.S. metal location post for on a 4" Aspen from which cor. bears East 81.0'

Certified corner restoration certificate prepared: Yes No

Filed in county records at _____ Date _____ County Document No. _____

Identified on aerial photo No. _____ Which is filed at _____

Index No. R-13
(Alphabetical-Numerical)LAND CORNER RECORD
(RECTANGULAR SURVEYS)

R9-7150-4 (Rev. 6/13/67)

GPO 806-924

T. 149N R. 25W5thMer. N.F. Chippewa County Itasca State MinnesotaSection 1

Corner common to sections

212227and 28

EXISTING SURVEYS

Original Government Survey

Year surveyed 1875
Original monument Wood post
(Wood post, stone, pile of stones, pipe, etc.)

Bearing Trees

Species Tamarack
Diameter 8"
Bearing N47°W
Distance 21.78'

Subsequent Corner Restoration

Year surveyed _____ By _____
Where filed or recorded _____
Monument _____
(Original, concrete post, iron rod, etc.)

Bearing Trees, Reference Objects

Species _____
Diameter _____
Bearing _____
Distance _____

Original Evidence Found

Year of search 1969 By G.A. McDonald
Monument found _____

Original Bearing Trees Found

Species Tam. stump
Diameter 12"
Bearing N47°W
Distance 21.78'

Evidence of Subsequent Corner Restoration Found

Year of search _____ By _____
SEE CORNER AFFIDAVIT

Bearing Trees, Reference Objects

Species _____
Diameter _____
Bearing _____
Distance _____

Index No. R-17
(Alphabetical - Numerical)LAND CORNER RECORD
(RECTANGULAR SURVEYS)R9-7 150-4 (Rev. 6/13/67)
GPO 808-924T. 149 N R. 25 W 5th Mer. N.F. Chippewa County Itasca State MINN.
Section _____ Corner common to sections 22, 23, 26 and 27

EXISTING SURVEYS

Original Government Survey

Year surveyed 1875
Original monument wood post
(wood post, stone, pile of stones, pipe, etc.)

Bearing Trees

Species Cedar Tamarack
Diameter 10" 14"
Bearing S44°W N49°W
Distance 5.28' 23.1'

Subsequent Corner Restoration

Year surveyed _____ By _____
Where filed or recorded _____
Monument _____
(Original, concrete post, iron rod, etc.)

Bearing Trees, Reference Objects

Species _____
Diameter _____
Bearing _____
Distance _____

Original Evidence Found

Year of search 1967 By R.H. McDonald
Monument found _____

Original Bearing Trees Found

Species Cedar stump Tamarack stump
Diameter 10" 16"
Bearing S46°W N49°W
Distance 5.28' 23.1'

Evidence of Subsequent Corner Restoration Found

Year of search _____ By _____
SEE CORNER AFFIDAVIT

Bearing Trees, Reference Objects

Species _____
Diameter _____
Bearing _____
Distance _____

Index No. R-19
(Alphabetical - Numerical)

LAND CORNER RECORD
(RECTANGULAR SURVEYS)

R9-7150-4 (Rev. 6/13/67)
GPO 808-924

T. 149 N R. 25 W 5th Mer. N.F. Chippewa County Itasca State MINN.
Quarter Corner common to sections 23 26 and _____

EXISTING SURVEYS

Original Government Survey

Year surveyed 1875
Original monument wood post
(wood post, stone, sig. of stones, pipe, etc.)

Bearing Trees

Species Aspen White pine
Diameter 20" 6"
Bearing N6°E S20°E
Distance 15.84' 15.84'

Subsequent Corner Restoration

Year surveyed _____ By _____
Where filed or recorded _____
Monument _____
(Original, concrete post, iron rod, etc.)

Bearing Trees, Reference Objects

Species _____
Diameter _____
Bearing _____
Distance _____

Original Evidence Found

Year of search 1969 By RH. McDonald
Monument found None

Original Bearing Trees Found

Species _____
Diameter _____
Bearing _____
Distance _____

Evidence of Subsequent Corner Restoration Found

Year of search _____ By _____

Bearing Trees, Reference Objects

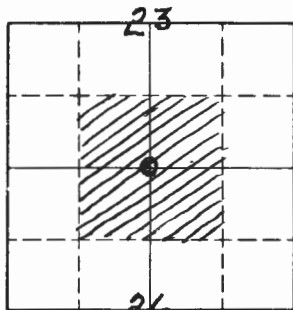

Sketch

○ Corner ▨ F.S. Land

Relation of Evidence to Record Features Along Section Lines

Section line to sections _____
 Object _____
 Record distance _____
 Measured distance _____

Other Evidence

Describe evidence of use and occupation such as roads, fences, clearings, timber cutting lines, plantations, etc.. Cite source of testimony if any. Found several burned pine stumps in this area but no evidence of orig. corner.

At time of search:

1. Did you have the record description?

Yes No _____

2. How was search area located?

Pacing, chaining, photos, maps, etc. _____

3. Mon hours spent in search 2

4. Do you think additional search might recover evidence? Yes _____ No

Perpetuation Record

Monument and accessories established. Include brief description of area. _____

Certified corner restoration certificate prepared: Yes _____ No _____

Filed in county records at _____ Date _____ County Document No. _____

5. Signature Robert H. M. [Signature] Identified on aerial photo No. _____ Which is filed at _____

Index No. T-1
(Alphabetical - Numerical)

LAND CORNER RECORD
(RECTANGULAR SURVEYS)

R9-7150-4 (Rev. 6/13/67)
GPO 905-924

T. 149 N R. 25-26 W 5th Mer. N.F. Chippewa County Itasca State MINN.
Quarter Corner common to sections 25, 30 and _____

EXISTING SURVEYS

Original Government Survey

Year surveyed 1875
Original monument Wood post
(wood post, stone, size of stones, pipe, etc.)

Bearing Trees

Species	Diameter	Bearing	Distance
<u>Cedar</u>	<u>8"</u>	<u>East</u>	<u>4.6'</u>
<u>Cedar</u>	<u>9"</u>	<u>S16°W</u>	<u>3.9'</u>

Subsequent Corner Restoration

Year surveyed _____ By _____
Where filed or recorded _____
Monument _____
(Original, concrete post, iron rod, etc.)

Bearing Trees, Reference Objects

Species	Diameter	Bearing	Distance
_____	_____	_____	_____
_____	_____	_____	_____
_____	_____	_____	_____
_____	_____	_____	_____

Original Evidence Found

Year of search 1968 By R.H. McDonald
Monument found wood post

Original Bearing Trees Found

Species	Diameter	Bearing	Distance
<u>Cedar windfall</u>	<u>10"</u>	<u>S67°E</u>	<u>4.6'</u>
<u>Cedar windfall</u>	_____	<u>S20°W</u>	<u>3.9</u>

Evidence of Subsequent Corner Restoration Found

Year of search _____ By _____
SEE CORNER AFFIDAVIT

Bearing Trees, Reference Objects

Species	Diameter	Bearing	Distance
_____	_____	_____	_____
_____	_____	_____	_____
_____	_____	_____	_____
_____	_____	_____	_____

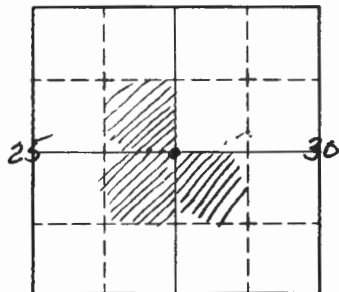

Sketch

○ Corner ▨ F.S. Land

Relation of Evidence to Record Features Along Section Lines

Section line to sections _____
 Object _____
 Record distance _____
 Measured distance _____

Other Evidence

Describe evidence of use and occupation such as roads, fences, clearings, timber cutting lines, plantations, etc.. Cite source of testimony if any.

F.S. metal location poster on orig. B.T. date 1935

At time of search:

1. Did you have the record description?

Yes No _____

2. How was search area located?

Pacing, chaining, photos, maps, etc. _____

3. Man hours spent in search _____

4. Do you think additional search might recover evidence? Yes _____ No _____

5. Signature

[Handwritten Signature]

Perpetuation Record

Monument and accessories established. Include brief description of area.

*Set a 2" φ, 5' long steel pipe w/ brass Cap MKD T149N
 R26W R25W
 Cedar 7" S59°E 19.9 Ft. MKD 1/4 S30 BT
 Cedar 12" N40E 12.8 Ft. MKD 1/4 S30 BT
 Steel sign post w/ F.S. signs 54-2
 54-4 set East
 525 1/4 530
 1968
 RLS NO 6807*

Certified corner restoration certificate prepared: Yes _____ No _____

Filed in county records at _____ Date _____ County Document No. _____

Identified on aerial photo No. _____ Which is filed at _____

Index No. T-9
(Alphabetical - Numerical)

LAND CORNER RECORD
(RECTANGULAR SURVEYS)

R9-7150-4 (Rev. 6/13/67)
 GPO 808-924

T. 149 N R. 25 W 5th Mer. N.F. Chippewa County Itasca State MINN.
Quarter Corner common to sections 28, 29 and _____

EXISTING SURVEYS

Original Government Survey

Year surveyed 1875
 Original monument Wood post
(Wood post, stone, pile of stones, pipe, etc.)

Bearing Trees

Species	<u>Maple</u>	<u>Maple</u>	_____
Diameter	<u>7"</u>	<u>6"</u>	_____
Bearing	<u>N24°W</u>	<u>S64°E</u>	_____
Distance	<u>9.9'</u>	<u>17.16'</u>	_____

Subsequent Corner Restoration

Year surveyed _____ By _____
 Where filed or recorded _____
 Monument _____
(Original, concrete post, iron rod, etc.)

Bearing Trees, Reference Objects

Species	_____	_____	_____
Diameter	_____	_____	_____
Bearing	_____	_____	_____
Distance	_____	_____	_____

Original Evidence Found

Year of search 1969 By Robert McDonald
 Monument found _____

Original Bearing Trees Found

Species	_____	_____	_____
Diameter	_____	_____	_____
Bearing	_____	_____	_____
Distance	_____	_____	_____

Evidence of Subsequent Corner Restoration Found

Year of search _____ By _____

Bearing Trees, Reference Objects

Species	_____	_____	_____
Diameter	_____	_____	_____
Bearing	_____	_____	_____
Distance	_____	_____	_____

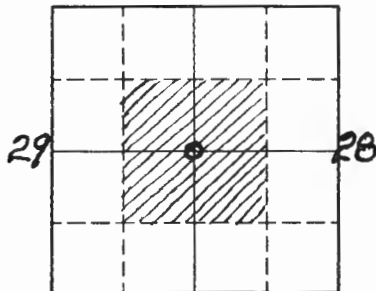

Sketch

○ Corner ▨ F.S. Land

Relation of Evidence to Record Features Along Section Lines

Section line to sections _____
 Object _____
 Record distance _____
 Measured distance _____

Other Evidence

Describe evidence of use and occupation such as roads, fences, clearings, timber cutting lines, plantations, etc.. Cite source of testimony if any. _____

At time of search:

1. Did you have the record description?
 Yes No _____

2. How was search area located?
 Pacing, chaining, photos, maps,
 etc. _____

3. Man hours spent in search 3

4. Do you think additional search might
 recover evidence? Yes _____ No

5. Signature AM Donald

Perpetuation Record

Monument and accessories established. Include brief description of area.
I placed F.S. meta location pester on a 18" maple
from which cor. bears West 17'

Certified corner restoration certificate prepared: Yes _____ No _____
 Filed in county records at _____ Date _____ County Document No. _____
 Identified on aerial photo No. _____ Which is filed at _____

Index No. T-13
(Alphabetical - Numerical)LAND CORNER RECORD
(RECTANGULAR SURVEYS)R9-7150-4 (Rev. 6/13/67)
GPO 808-924T. 149 N R. 25 W 5th Mer. N.F. Chippewa County Itasca State Minn.
Quarter Corner common to sections 27, 28, and _____

EXISTING SURVEYS

Original Government Survey

Year surveyed 1875
Original monument Wood post
(Wood post, stone, pile of stones, pipe, etc.)

Bearing Trees

Species Cedar White Birch
Diameter 10" 10"
Bearing S80°W N29°E
Distance 3.96' 17.82'

Subsequent Corner Restoration

Year surveyed _____ By _____
Where filed or recorded _____
Monument _____
(Original, concrete post, iron rod, etc.)

Bearing Trees, Reference Objects

Species _____
Diameter _____
Bearing _____
Distance _____

Original Evidence Found

Year of search 1967 By R.H. McDonald
Monument found None

Original Bearing Trees Found

Species _____
Diameter _____
Bearing _____
Distance _____

Evidence of Subsequent Corner Restoration Found

Year of search _____ By _____

Bearing Trees, Reference Objects

Species _____
Diameter _____
Bearing _____
Distance _____

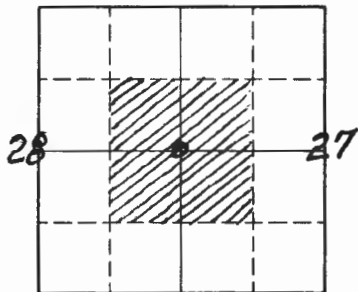

Sketch

○ Corner ▨ F.S. Land

Relation of Evidence to Record Features Along Section Lines

Section line to sections _____
 Object _____
 Record distance _____
 Measured distance _____

Other Evidence

Describe evidence of use and occupation such as roads, fences, clearings, timber cutting lines, plantations, etc.. Cite source of testimony if any. _____

At time of search:

1. Did you have the record description?

Yes No _____

2. How was search area located?

Pacing, chaining, photos, maps, etc. _____

3. Man hours spent in search 2

4. Do you think additional search might recover evidence? Yes _____ No

5. Signature W. M. Donald

Perpetuation Record

Monument and accessories established. Include brief description of area. _____

Certified corner restoration certificate prepared: Yes _____ No _____

Filed in county records at _____ Date _____ County Document No. _____

Identified on aerial photo No. _____ Which is filed at _____

Relation of Evidence to Record Features Along Section Lines

Section line to sections _____
 Object _____
 Record distance _____
 Measured distance _____

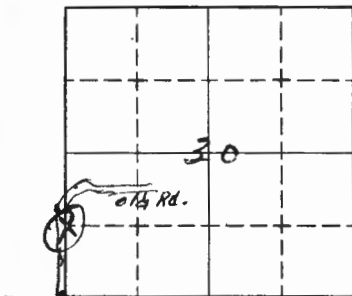

Co. Rd. Sketch

○ Corner F.S. Land

Other Evidence

Describe evidence of use and occupation such as roads, fences, clearings, timber cutting lines, plantations, etc.. Cite source of testimony if any. _____

*North of Co. Road on old trail. East side of trail in
 Balsam s. Spruce scribbled stroke.*

At time of search:

1. Did you have the record description?

Yes _____ No _____

2. How was search area located?

Pacing, chaining, photos, maps,
 etc. _____

3. Man hours spent in search _____

4. Do you think additional search might
 recover evidence? Yes _____ No _____

5. Signature *John E. Kincaid*

Perpetuation Record

Monument and accessories established. Include brief description of area. _____

Certified corner restoration certificate prepared: Yes _____ No _____

Filed in county records at _____ Date _____ County Document No. _____

Identified on aerial photo No. _____ Which is filed at _____

T. 149N R. 25W 5th Mer. N.F. Chippewa County Itasca State MINN.
Quarter Corner common to sections 29, 32, and _____

EXISTING SURVEYS

Original Government Survey

Year surveyed 1875
 Original monument Wood Post
(Wood post, stone, pile of stones, pipe, etc.)

Bearing Trees

Species Cedar Cedar
 Diameter 8" 9"
 Bearing S7°W N54°W
 Distance 7.92' 3.96'

Subsequent Corner Restoration

Year surveyed _____ By _____
 Where filed or recorded _____
 Monument _____
(Original, concrete post, iron rod, etc.)

Bearing Trees, Reference Objects

Species _____
 Diameter _____
 Bearing _____
 Distance _____

Original Evidence Found

Year of search 1967 By R.H. McDonald
 Monument found Sq. Wood post

Original Bearing Trees Found

Species Cedar (dead) Cedar stump
 Diameter _____
 Bearing S7°W N54°W
 Distance 7.92' 3.96'

Evidence of Subsequent Corner Restoration Found

Year of search _____ By _____
SEE CORNER AFFIDAVIT

Bearing Trees, Reference Objects

Species _____
 Diameter _____
 Bearing _____
 Distance _____

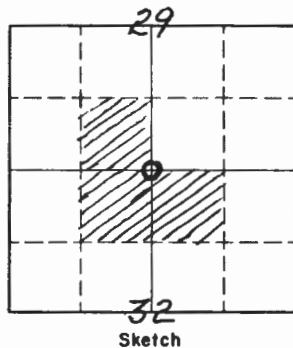

Sketch

○ Corner ▨ F.S. Land

Relation of Evidence to Record Features Along Section Lines

Section line to sections _____
 Object _____
 Record distance _____
 Measured distance _____

Other Evidence

Describe evidence of use and occupation such as roads, fences, clearings, timber cutting lines, plantations, etc.. Cite source of testimony if any. _____

At time of search:

1. Did you have the record description?
 Yes No _____

2. How was search area located?
 Pacing, chaining, photos, maps, etc. _____

3. Man hours spent in search _____

4. Do you think additional search might recover evidence? Yes _____ No _____

5. Signature *James Donald*

Perpetuation Record

Monument and accessories established. Include brief description of area.

Set a 2" φ steel pipe w/ brass cap MKD. T149NR25W
Cedar 8" N55°E 8.3' MKD 1/4 S29 BT *1 S29*
Cedar 9" S37°E 19.5' MKD 1/4 S32 BT *7 S32*
Cedar 6" S37°W 15.5' MKD 1/4 S32 BT *1967*
Steel sign post with F.S. signs 54-2
54-4 attached set East 4.45'

Certified corner restoration certificate prepared: Yes No _____

Filed in county records at _____ Date _____ County Document No. _____

Identified on aerial photo No. _____ Which is filed at _____

Index No. V-9
(Alphabetical - Numerical)

LAND CORNER RECORD
(RECTANGULAR SURVEYS)

R9-7 150-4 (Rev. 6/13/67)
 GPO 805-924

T. 149N R. 25W Mer. N.F. Chippewa County Itasca State MINN.
Section Corner common to sections 28, 29, 32 and 33

EXISTING SURVEYS

Original Government Survey

Year surveyed 1875
 Original monument Wood post
(Wood post, stone, pile of stones, pipe, etc.)

Bearing Trees

Species	White Pine	Cedar	Fir
Diameter	<u>20"</u>	<u>10"</u>	<u>6"</u>
Bearing	<u>N2°E</u>	<u>S21°W</u>	<u>N46°W</u>
Distance	<u>1.32'</u>	<u>14.52</u>	<u>9.24'</u>

Subsequent Corner Restoration

Year surveyed _____ By _____
 Where filed or recorded _____
 Monument _____
(Original, concrete post, iron rod, etc.)

Bearing Trees, Reference Objects

Species	_____
Diameter	_____
Bearing	_____
Distance	_____

Original Evidence Found

Year of search 1968 By Robert McDonald
 Monument found None.

Original Bearing Trees Found

Species	_____
Diameter	_____
Bearing	_____
Distance	_____

Evidence of Subsequent Corner Restoration Found

Year of search _____ By _____

Bearing Trees, Reference Objects

Species	_____
Diameter	_____
Bearing	_____
Distance	_____

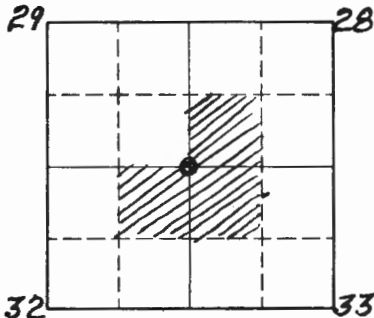

Sketch

○ Corner ▨ F.S. Land

Relation of Evidence to Record Features Along Section Lines

Section line to sections _____
 Object _____
 Record distance _____
 Measured distance _____

Other Evidence

Describe evidence of use and occupation such as roads, fences, clearings, timber cutting lines, plantations, etc.. Cite source of testimony if any. _____

At time of search:

1. Did you have the record description?
 Yes No _____

2. How was search area located?
 Pacing, chaining, photos, maps,
 etc. _____

3. Man hours spent in search 3

4. Do you think additional search might
 recover evidence? Yes _____ No

Perpetuation Record

Monument and accessories established. Include brief description of area. _____

Certified corner restoration certificate prepared: Yes _____ No _____

Filed in county records at _____ Date _____ County Document No. _____

Identified on aerial photo No. _____ Which is filed at _____

5. Signature [Handwritten Signature]

Index No. V-11
(Alphabetical-Numerical)

LAND CORNER RECORD
(RECTANGULAR SURVEYS)

R9-7150-4 (Rev. 6/13/67)
 GPO 806-924

T. 149N R. 250 Mer. N.F. Chippewa County Itasca State Minn.
Quarter Corner common to sections 28, 33 and _____

EXISTING SURVEYS

Original Government Survey

Year surveyed 1875
 Original monument Wood post
(Wood post, stone, pile of stones, pipe, etc.)

Bearing Trees

Species Maple Maple
 Diameter 7" 7"
 Bearing N12°W S86°E
 Distance 9.24' 1.9A

Subsequent Corner Restoration

Year surveyed _____ By _____
 Where filed or recorded _____
 Monument _____
(Original, concrete post, iron rod, etc.)

Bearing Trees, Reference Objects

Species _____
 Diameter _____
 Bearing _____
 Distance _____

Original Evidence Found

Year of search 1969 By Robert McDonald
 Monument found None

Original Bearing Trees Found

Species _____
 Diameter _____
 Bearing _____
 Distance _____

Evidence of Subsequent Corner Restoration Found

Year of search _____ By _____

Bearing Trees, Reference Objects

Species _____
 Diameter _____
 Bearing _____
 Distance _____

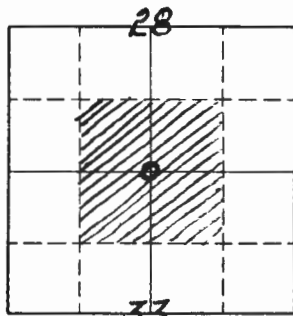

Sketch

○ Corner ▨ F.S. Land

Relation of Evidence to Record Features Along Section Lines

Section line to sections _____
 Object _____
 Record distance _____
 Measured distance _____

Other Evidence

Describe evidence of use and occupation such as roads, fences, clearings, timber cutting lines, plantations, etc.. Cite source of testimony if any. _____

At time of search:

1. Did you have the record description?

Yes No _____

2. How was search area located?

Pacing, chaining, photos, maps, etc. _____

3. Man hours spent in search 2

4. Do you think additional search might recover evidence? Yes _____ No

5. Signature [Signature]

Perpetuation Record

Monument and accessories established. Include brief description of area. _____

Certified corner restoration certificate prepared: Yes _____ No _____

Filed in county records at _____ Date _____ County Document No. _____

Identified on aerial photo No. _____ Which is filed at _____

Index No. V-13
(Alphabetical - Numerical)

LAND CORNER RECORD
(RECTANGULAR SURVEYS)

R9-7150-4 (Rev. 6/13/67)
 GPO 806-924

T. 149N R. 25W Mer. N.F. Chippewa County Itasca State Minn.
5th Section Corner common to sections 27, 28, 33 and 34

EXISTING SURVEYS \

Original Government Survey

Year surveyed 1875
 Original monument Wood post
(wood post, stone, pile of stones, pipe, etc.)

Bearing Trees

Species	Maple	Linden	Aspen	Fir
Diameter	8"	7"	14"	8"
Bearing	S21°W	N40°W	S52°E	N36°E
Distance	10.56'	9.9'	3.3'	36.96'

Subsequent Corner Restoration

Year surveyed _____ By _____
 Where filed or recorded _____
 Monument _____
(Original, concrete post, iron rod, etc.)

Bearing Trees, Reference Objects

Species	_____	_____	_____
Diameter	_____	_____	_____
Bearing	_____	_____	_____
Distance	_____	_____	_____

Original Evidence Found

Year of search 1969 By R.H. McDonald
 Monument found _____

Original Bearing Trees Found

Species	_____	_____	_____
Diameter	_____	_____	_____
Bearing	_____	_____	_____
Distance	_____	_____	_____

Evidence of Subsequent Corner Restoration Found

Year of search _____ By _____

Bearing Trees, Reference Objects

Species	_____	_____	_____
Diameter	_____	_____	_____
Bearing	_____	_____	_____
Distance	_____	_____	_____

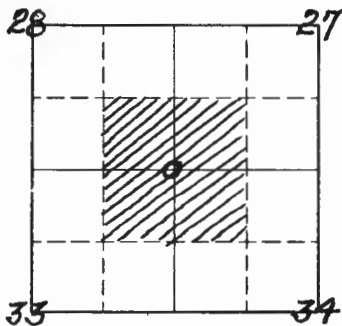

Sketch

○ Corner ▨ F.S. Land

Relation of Evidence to Record Features Along Section Lines

Section line to sections _____
 Object _____
 Record distance _____
 Measured distance _____

Other Evidence

Describe evidence of use and occupation such as roads, fences, clearings, timber cutting lines, plantations, etc.. Cite source of testimony if any. _____

At time of search:

1. Did you have the record description?

Yes No _____

2. How was search area located?

Pacing, chaining, photos, maps, etc. _____

3. Man hours spent in search 2

4. Do you think additional search might recover evidence? Yes _____ No

5. Signature R. M. Donald

Perpetuation Record

Monument and accessories established. Include brief description of area. _____

Certified corner restoration certificate prepared: Yes _____ No _____

Filed in county records at _____ Date _____ County Document No. _____

Identified on aerial photo No. _____ Which is filed at _____

Index No. V-W-17
(Alphabetical - Numerical)

LAND CORNER RECORD
(RECTANGULAR SURVEYS)

R9-7150-4 (Rev. 6/13/67)
 GPO 805-924

T. 149 N R. 25 W 5th Mer. N.F. Chippewa County Itasca State Minn.
 Witness Corner - Sec. Corner common to sections 26, 27, B4 and 35

EXISTING SURVEYS

Original Government Survey

Year surveyed 1875
 Original monument wood post
(Wood post, stone, pile of stones, pipe, etc.)

Bearing Trees

Species Aspen Aspen
 Diameter 10" 6"
 Bearing N 36° E N 63° W
 Distance 33.66' 21.12'

Subsequent Corner Restoration

Year surveyed _____ By _____
 Where filed or recorded _____
 Monument _____
(Original, concrete post, iron rod, etc.)

Bearing Trees, Reference Objects

Species _____
 Diameter _____
 Bearing _____
 Distance _____

Original Evidence Found

Year of search 1969 By RH McDonald
 Monument found None

Original Bearing Trees Found

Species _____
 Diameter _____
 Bearing _____
 Distance _____

Evidence of Subsequent Corner Restoration Found

Year of search _____ By _____

Bearing Trees, Reference Objects

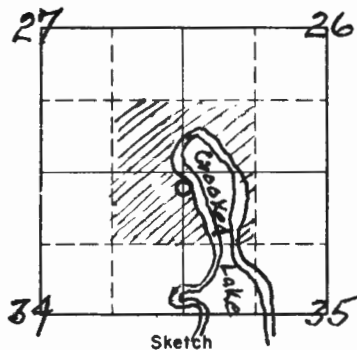

○ Corner ▨ F.S. Land

Relation of Evidence to Record Features Along Section Lines

Section line to sections _____

Object _____

Record distance _____

Measured distance _____

Other Evidence

Describe evidence of use and occupation such as roads, fences, clearings, timber cutting lines, plantations, etc.. Cite source of testimony if any. _____

Perpetuation Record

Monument and accessories established. Include brief description of area. _____

Certified corner restoration certificate prepared: Yes _____ No _____

Filed in county records at _____ Date _____ County Document No. _____

Identified on aerial photo No. _____ Which is filed at _____

- At time of search:
1. Did you have the record description?
Yes No _____

 2. How was search area located?
Pacing, chaining, photos, maps,
etc. _____

 3. Man hours spent in search 2

 4. Do you think additional search might
recover evidence? Yes _____ No

 5. Signature [Handwritten Signature]

Index No. X-13
(Alphabetical-Numerical)

LAND CORNER RECORD
(RECTANGULAR SURVEYS)

R9-7150-4 (Rev. 6/13/67)
 GPO 808-924

T. 149N R. 25W 5th Mer. N.F. Chippewa County Itasca State MINN.
Quarter Corner common to sections 33 34 and _____

EXISTING SURVEYS

Original Government Survey

Year surveyed 1875
 Original monument Wood Post
(Wood post, stone, pile of stones, pipe, etc.)

Bearing Trees

Species White pine White pine
 Diameter 8" 6"
 Bearing S43°W S47°E
 Distance 5.94 1.98'

Subsequent Corner Restoration

Year surveyed _____ By _____
 Where filed or recorded _____
 Monument _____
(Original, concrete post, iron rod, etc.)

Bearing Trees, Reference Objects

Species _____
 Diameter _____
 Bearing _____
 Distance _____

Original Evidence Found

Year of search 1967 By RH McDonald
 Monument found None

Original Bearing Trees Found

Species _____
 Diameter _____
 Bearing _____
 Distance _____

Evidence of Subsequent Corner Restoration Found

Year of search _____ By _____

Bearing Trees, Reference Objects

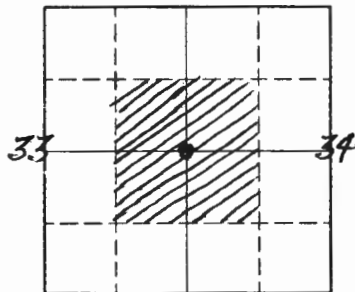

Sketch

○ Corner ▨ F.S. Lond

Relation of Evidence to Record Features Along Section Lines

Section line to sections _____
 Object _____
 Record distance _____
 Measured distance _____

Other Evidence

Describe evidence of use and occupation such as roads, fences, clearings, timber cutting lines, plantations, etc.. Cite source of testimony if any. _____

At time of search:

1. Did you have the record description?

Yes No _____

2. How was search area located?

Pacing, chaining, photos, maps, etc. _____

3. Man hours spent in search 2

4. Do you think additional search might recover evidence? Yes _____ No

5. Signature [Signature]

Perpetuation Record

Monument and accessories established. Include brief description of area. _____

Certified corner restoration certificate prepared: Yes _____ No _____

Filed in county records at _____ Date _____ County Document No. _____

Identified on aerial photo No. _____ Which is filed at _____

Index No. Z-3
(Alphabetical - Numerical)

LAND CORNER RECORD
(RECTANGULAR SURVEYS)

RS-5680-11 (5/12/81)

T. 149 R. 25 Mer. N.F. Chippewa County Itasca State Minnesota
Quarter Corner common to sections 31 end

EXISTING SURVEYS

Original Government Survey

Year surveyed _____
 Original monument _____
(Wood post, stone, pile of stones, pipe, etc.)

Bearing Trees

Species _____
 Diameter _____
 Bearing _____
 Distance _____

Subsequent Corner Restoration

Year surveyed _____ By _____
 Where filed or recorded _____
 Monument _____
(Original, concrete post, iron rod, etc.)

Bearing Trees, Reference Objects

Species _____
 Diameter _____
 Bearing _____
 Distance _____

Original Evidence Found

Year of search _____ By _____
 Monument found _____

Original Bearing Trees Found

Species _____
 Diameter _____
 Bearing _____
 Distance _____

Evidence of Subsequent Corner Restoration Found

Year of search _____ By _____

See Corner Affidavit

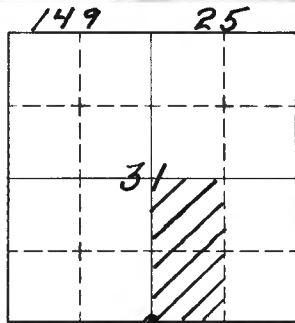

Sketch

○ Corner ▨ F.S. Land

Relation of Evidence to Record Features Along Section Lines

Section line to sections _____
 Object _____
 Record distance _____
 Measured distance _____

Other Evidence

Describe evidence of use and occupation such as roads, fences, clearings, timber cutting lines, plantations, etc.. Cite source of testimony if any. _____

At time of search:

1. Did you have the record description?

Yes _____ No _____

2. How was search area located?

Pacing, chaining, photos, maps, etc. _____

3. Man hours spent in search _____

4. Do you think additional search might recover evidence? Yes _____ No _____

5. Signature _____

Perpetuation Record

Monument and accessories established. Include brief description of area. Set a 2" inside dia. 5' Long gal. wrought iron pipe Filled w/ Concrete & Capped w/a 3" dia bronze tablet stamped

<u>ELM</u>	<u>ELM</u>	<u>T149 N R 25 W</u>
<u>4"</u>	<u>7"</u>	<u>S.C.</u>
<u>N18°E</u>	<u>N34½W</u>	<u>¼ S 31</u>
<u>23.77'</u>	<u>34.9'</u>	<u>1961</u>
		<u>RLS. No. 3628</u>

Certified corner restoration certificate prepared: Yes No _____

Filed in county records at Itasca Date 1961 County Document No. _____

Identified on aerial photo No. _____ Which is filed at _____

Index No. Z-5
(Alphabetical - Numerical)

LAND CORNER RECORD
(RECTANGULAR SURVEYS)

RS-660-11 (6/12/61)

T. 149 R. 25 Mer. N.F. Chippewa County Itasca State Minnesota
SE Corner common to sections 31 and 32
Quarter

EXISTING SURVEYS

Original Government Survey

Year surveyed _____

Original monument _____
(Wood post, stone, pile of stones, pipe, etc.)

Bearing Trees

Species _____

Diameter _____

Bearing _____

Distance _____

Subsequent Corner Restoration

Year surveyed _____ By _____

Where filed or recorded _____

Monument _____
(Original, concrete post, iron rod, etc.)

Bearing Trees, Reference Objects

Species _____

Diameter _____

Bearing _____

Distance _____

Original Evidence Found

Year of search _____ By _____

Monument found _____

Original Bearing Trees Found

Species _____

Diameter _____

Bearing _____

Distance _____

Evidence of Subsequent Corner Restoration Found

Year of search _____ By _____

See CORNER AFFIDAVIT

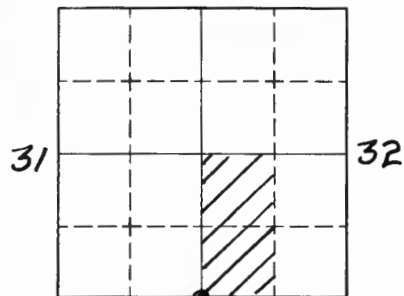

Sketch

○ Corner ▨ F.S. Land

Relation of Evidence to Record Features Along Section Lines

Section line to sections _____
 Object _____
 Record distance _____
 Measured distance _____

Other Evidence

Describe evidence of use and occupation such as roads, fences, clearings, timber cutting lines, plantations, etc.. Cite source of testimony if any. _____

At time of search:

1. Did you have the record description?

Yes _____ No _____

2. How was search area located?

Pacing, chaining, photos, maps, etc. _____

3. Man hours spent in search _____

4. Do you think additional search might recover evidence? Yes _____ No _____

5. Signature _____

Perpetuation Record

Monument and accessories established. Include brief description of area. *Set a 6" dia. 5' Long cylindrical Concrete Monument w/a 3" dia bronze tablet stamped.*

			<i>T 149 N R 26 W</i>
<i>Rock</i>	<i>Cedar Post</i>	<i>Cedar Post</i>	<i>331 332</i>
<i>3' x 2' x 1'</i>	<i>East</i>	<i>West</i>	<i>S.C.</i>
<i>N 5° 6'</i>	<i>2.0'</i>	<i>2.0'</i>	<i>1961</i>
<i>17.4'</i>			<i>RLS NO. 3628</i>

Certified corner restoration certificate prepared: Yes No _____

Filed in county records at *Itasca* Date *1961* County Document No. _____

Identified on aerial photo No. _____ Which is filed at _____

Index No. Z-11
(Alphabetical-Numerical)

48 25 { Book #2
Page #34

LAND CORNER RECORD
(RECTANGULAR SURVEYS)

79-7150-4 (Rev. 6/13/67)
 GPO 508-127

T. 149 R. 25 Mer. N.F. Chippewa County Itasca State Minnesota
Standard 7/4 Corner common to sections 33 and _____

EXISTING SURVEYS

Original Government Survey

Year surveyed _____
 Original monument _____
(Wood post, stone, pile of stones, pipe, etc.)

Bearing Trees

Species Was: _____
 Diameter _____
 Bearing Allice Wood _____
 Distance _____

Subsequent Corner Restoration

Year surveyed 1967 By Itasca County
 Where filed or recorded Itasca County Court House
 Monument 1" Capped Iron pipe
(Original, concrete, wood, iron rod, etc.)

Bearing Trees, Reference Objects

Species	<u>Oak</u>	<u>Oak</u>
Diameter	<u>5"</u>	<u>4"</u>
Bearing	<u>N 81° W</u>	<u>N 27° E</u>
Distance	<u>12.85'</u>	<u>11.37'</u>

Original Evidence Found

Year of search _____ By _____
 Monument found _____

Original Bearing Trees Found

Species _____
 Diameter _____
 Bearing _____
 Distance _____

Evidence of Subsequent Corner Restoration Found

Year of search _____ By _____

Twin Maple

Bearing Trees, Reference Objects	<u>Oak</u>
Diameter	<u>7"</u>
Bearing	<u>N 75° W</u>
Distance	<u>12.85'</u>
Scraper visible	<u>Scraper visible</u>

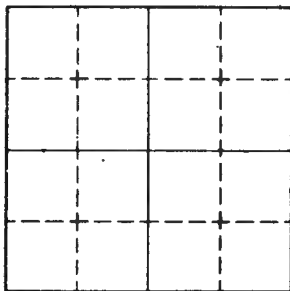

Sketch

Corner F.S. Land

Relation of Evidence to Record Features Along Section Lines

Section line to sections _____
Object _____
Record distance _____
Measured distance _____

Other Evidence

Describe evidence of use and occupation such as roads, fences, clearings, timber cutting lines, plantations, etc.. Cite source of testimony if any. _____

At time of search:

1. Did you have the record description?

Yes _____ No _____

2. How was search area located?

Pacing, chaining, photos, maps,
etc. _____

3. Man hours spent in search _____

4. Do you think additional search might
recover evidence? Yes _____ No _____

5. Signature _____

Perpetuation Record

Monument and accessories established. Include brief description of area. _____

Certified corner restoration certificate prepared: Yes _____ No _____

Filed in county records at _____ Date _____ County Document No. _____

Identified on aerial photo No. _____ Which is filed at _____

Index No. Z-13
(Alphabetical - Numerical)

LAND CORNER RECORD
(RECTANGULAR SURVEYS)

89-8880-11 (8/18/81)

T. 149 R. 25 5th Mer. N.F. Chippewa County Itasca State Minnesota
Std Quarter Corner common to sections 33, 34 and _____

EXISTING SURVEYS

Original Government Survey

Year surveyed _____
 Original monument _____
(Wood post, stone, pile of stones, pipe, etc.)

Bearing Trees

Species _____
 Diameter _____
 Bearing _____
 Distance _____

Subsequent Corner Restoration

Year surveyed _____ By _____
 Where filed or recorded _____
 Monument _____
(Original, concrete post, iron rod, etc.)

Bearing Trees, Reference Objects

Species _____
 Diameter _____
 Bearing _____
 Distance _____

Original Evidence Found

Year of search _____ By _____
 Monument found _____

Original Bearing Trees Found

Species _____
 Diameter _____
 Bearing _____
 Distance _____

Evidence of Subsequent Corner Restoration Found

Year of search _____ By _____

See Corner Affidavit

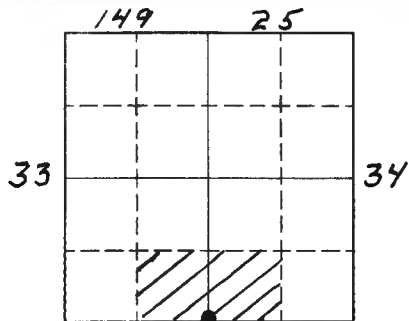

Sketch

○ Corner ▨ F.S. Land

Relation of Evidence to Record Features Along Section Lines

Section line to sections _____
 Object _____
 Record distance _____
 Measured distance _____

Other Evidence

Describe evidence of use and occupation such as roads, fences, clearings, timber cutting lines, plantations, etc.. Cite source of testimony if any.

At time of search:

1. Did you have the record description?

Yes _____ No _____

2. How was search area located?

Pacing, chaining, photos, maps, etc. _____

3. Man hours spent in search _____

4. Do you think additional search might recover evidence? Yes _____ No _____

5. Signature _____

Perpetuation Record

Monument and accessories established. Include brief description of area. *Set a 6" dia. 5' long cyl. concrete monument capped w/ a 3" dia. bronze tablet stamped.*

Birch Cedar Post
7" 4" x 4" x 6.5'
N40°E West
35.2' 4.0'

S.C.
T149N R25W
S33 | S34
1961
R.L.S. NO. 362B

Certified corner restoration certificate prepared: Yes No _____

Filed in county records at *Itasca* Date *1961* County Document No. _____

Identified on aerial photo No. _____ Which is filed at _____

Index No. Z-15
(Alphabetical - Numerical)

LAND CORNER RECORD
(RECTANGULAR SURVEYS)

RG-5000-11 (2/12/61)

T. 149 R. 25 5th Mer. N.F. Chippewa County Itasca State Minnesota
Std. Quarter Corner common to sections 34 and _____

EXISTING SURVEYS

Original Government Survey	Original Evidence Found
Year surveyed _____ Original monument _____ <small>(Wood post, stone, pile of stones, pipe, etc.)</small>	Year of search _____ By _____ Monument found _____
<p style="text-align: center;">Bearing Trees</p> Species _____ Diameter _____ Bearing _____ Distance _____	<p style="text-align: center;">Original Bearing Trees Found</p> Species _____ Diameter _____ Bearing _____ Distance _____
<p style="text-align: center;">Subsequent Corner Restoration</p>	<p style="text-align: center;">Evidence of Subsequent Corner Restoration Found</p>
Year surveyed _____ By _____ Where filed or recorded _____ Monument _____ <small>(Original, concrete post, iron rod, etc.)</small>	Year of search _____ By _____ <u>See Corner Affidavit</u>
<p style="text-align: center;">Bearing Trees, Reference Objects</p> Species _____ Diameter _____ Bearing _____ Distance _____	_____ _____ _____ _____

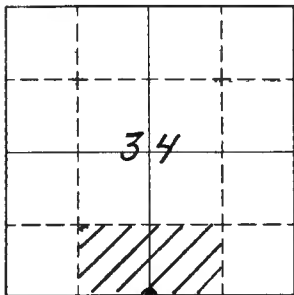

Sketch

○ Corner ▨ F.S. Land

Relation of Evidence to Record Features Along Section Lines

Section line to sections _____
 Object _____
 Record distance _____
 Measured distance _____

Other Evidence

Describe evidence of use and occupation such as roads, fences, clearings, timber cutting lines, plantations, etc.. Cite source of testimony if any. _____

At time of search:

1. Did you have the record description?

Yes _____ No _____

2. How was search area located?

Pacing, chaining, photos, maps, etc. _____

3. Man hours spent in search _____

4. Do you think additional search might recover evidence? Yes _____ No _____

5. Signature _____

Perpetuation Record

Monument and accessories established. Include brief description of area. Set a 6" dia. 5' Long Cylindrical Concrete Mon. Capped w/a 3" dia bronze tablet stamped

<u>Jack Pine</u>	<u>Cedar Post</u>	<u>T149N R26W</u>
<u>6"</u>	<u>4" x 4" x 6.5'</u>	<u>S.C.</u>
<u>N34°E</u>	<u>West</u>	<u>1/4 S34</u>
<u>92.3'</u>	<u>4.9'</u>	<u>1961</u>
		<u>R.L.S. NO. 362B</u>

Certified corner restoration certificate prepared: Yes No _____

Filed in county records at Itasca Date 1961 County Document No. _____

Identified on aerial photo No. _____ Which is filed at _____

T. 149 R. 25 Mer. N.F. Chippewa County Itasca State Minnesota
Std Cor Corner common to sections 34, 35 and _____

EXISTING SURVEYS

Original Government Survey

Year surveyed _____

Original monument _____
(Wood post, stone, pile of stones, pipe, etc.)

Bearing Trees

Species _____

Diameter _____

Bearing _____

Distance _____

Subsequent Corner Restoration

Year surveyed _____ By _____

Where filed or recorded _____

Monument _____
(Original, concrete post, iron rod, etc.)

Bearing Trees, Reference Objects

Species _____

Diameter _____

Bearing _____

Distance _____

Original Evidence Found

Year of search _____ By _____

Monument found _____

Original Bearing Trees Found

Species _____

Diameter _____

Bearing _____

Distance _____

Evidence of Subsequent Corner Restoration Found

Year of search _____ By _____

See Corner Affidavit

T149N R25W

Relation of Evidence to Record Features Along Section Lines

34

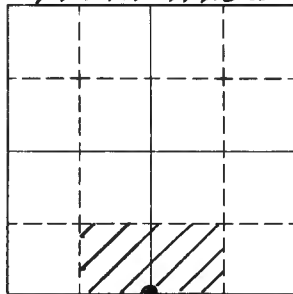

35

Sketch

○ Corner ▨ F.S. Land

Section line to sections _____
 Object _____
 Record distance _____
 Measured distance _____

Other Evidence

Describe evidence of use and occupation such as roads, fences, clearings, timber cutting lines, plantations, etc.. Cite source of testimony if any. _____

At time of search:

1. Did you have the record description?

Yes _____ No _____

2. How was search area located?

Pacing, chaining, photos, maps,
 etc. _____

3. Man hours spent in search _____

4. Do you think additional search might
 recover evidence? Yes _____ No _____

5. Signature _____

Perpetuation Record

Monument and accessories established. Include brief description of area. Set a 2"
inside dia. 5' Long gal. wrought iron pipe Filled w/
concrete & capped w/a 3" dia bronze tablet stamped

S.C.

<u>Maple</u>	<u>Birch</u>
<u>4"</u>	<u>6"</u>
<u>N 2 1/2° W</u>	<u>N 44° E,</u>
<u>29.4'</u>	<u>25.25'</u>

T149N R25W

S 34 | 335

1961

Certified corner restoration certificate prepared: Yes No _____

Filed in county records at Itasca Date 1961 County Document No. _____

Identified on aerial photo No. _____ Which is filed at _____

Index No. Z-23
(Alphabetical - Numerical)

62 Pg 28 of 14825

LAND CORNER RECORD
(RECTANGULAR SURVEYS)

RD-7150-4 (Rev. 6/13/67)
 GPO 802-127

T. 149 R. 25 S. Mer. N.F. CHIP County ITASCA State MINN.
QUARTER Corner common to sections 36 and _____

EXISTING SURVEYS

Original Government Survey

Year surveyed 1871

Original monument WOOD POST
(Wood post, stone, pile of stones, pipe, etc.)

Bearing Trees MAPLE

Species W. PINE SUGAR

Diameter 36 9

Bearing N76E N57W

Distance 27 45
17.8' 29.7'

Original Evidence Found

Year of search _____ By _____

Monument found _____

Original Bearing Trees Found

Species _____

Diameter _____

Bearing _____

Distance _____

Subsequent Corner Restoration

Year surveyed 1965 By ITASCA COUNTY

Where filed or recorded COURT HOUSE

Monument SET IRON PIPE W/ALUM. CAP
(Original, concrete post, iron rod, etc.)

Evidence of Subsequent Corner Restoration Found

Year of search 11-29-73 By CURT KRAUSE

FOUND IRON PIPE W/ALUM. CAP
18" ABOVE GROUND BOTH BT'S. OK
PUT BT TAGS ON TREES
CORNER IS ON HARDWOOD RIDGE
OLD BRUSH LINE IS 70' TO SOUTH

Bearing Trees, Reference Objects

Species BIRCH BASSWOOD

Diameter 5 10

Bearing N48W N26E

Distance 33.7 52.9'

Bearing Trees, Reference Objects

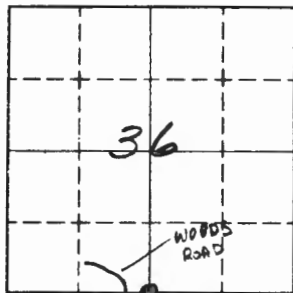

Sketch

○ Corner ▨ F.S. Land

Relation of Evidence to Record Features Along Section Lines

Section line to sections _____
 Object _____
 Record distance _____
 Measured distance _____

Other Evidence

Describe evidence of use and occupation such as roads, fences, clearings, timber cutting lines, plantations, etc.. Cite source of testimony if any. _____

At time of search:

1. Did you have the record description?

Yes No _____

2. How was search area located?

Pacing, chaining, photos, maps,
 etc. _____

3. Man hours spent in search 1/2

4. Do you think additional search might

recover evidence? Yes _____ No _____

5. Signature Carl Krause

Perpetuation Record

Monument and accessories established. Include brief description of area. _____

Certified corner restoration certificate prepared: Yes _____ No _____

Filed in county records at _____ Date _____ County Document No. _____

Identified on aerial photo No. _____ Which is filed at _____

Index File No. 2-23 CORNER RECORD (SEARCH) (Ref. FSM 7151.4) Tract or Survey No. _____ Cor. No. _____
 T 149 R. 25 R.D. Marcell County Itasca
 Merid. 5 N.F. Chip. State MN

CORNER DIAGRAM

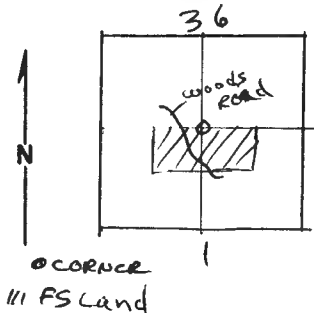

DESCRIBE CORNER MONUMENT FOUND 11-29-75 by CURT KRAUSE
 Found Itasca Co. IRON pipe w/ ALUM cap ~~flush w/ ground~~
 18" above ground

DESCRIBE BEARING TREES OR OTHER OFFICIAL ACCESSORIES FOUND

BIRCH	Basswood
5	10
N48W	N26E
33.7	52.9

PHOTO IDENTIFICATION DATA

Photo No. _____
 Filed At. _____
 Object Ident. _____
 Ident. By _____
Signature

DESCRIBE CORNER LOCATION RELATIVE TO NEAR-BY FEATURES, ALSO HOW TO REACH CORNER

BT's O.K.
 Corner is on Adwad Ridge - old brushed line 70' to south

PLANE COORDINATE POSITION DATA

State _____ Zone _____
 X _____
 Y _____
 Estab. By _____
Agency

CORNER RECORD (PERPETUATION)

MONUMENT: DESCRIBE NEW MONUMENT SET, OR WORK DONE TO PRESERVE EXISTING MONUMENT

9

ACCESSORIES : DESCRIBE NEW BT'S WITNESS OBJECTS ETC. ESTABLISHED, OR WORK DONE TO PRESERVE EXISTING EVIDENCE

10

Work Done By _____ Title _____ Date _____ State Registration No. or Agency _____

Certified Cor. Record Prepared ? Yes No Filed At: _____ Date _____

11

REMARKS

12

Index File No. T. R. M. Tract or Surv. No. Cor, 13