

LEGEND

○ = Corner having information on form 7100-52 in this file.

T148N R26W 5th PM

FILING INSTRUCTION

(Ref. FSM 7150)

File 7100-52 card record by letter and number coordinates behind the file guide for the township in which it falls.

File the 7100-52 card record by letter and then by number i.e., all A cards first, then B cards etc.

The first card behind the file guide (if data have been obtained and recorded) will be card A-1 for N.W. Township Corner, then card A-2 for 1/16 corner then card A-3 for 1/4 corner etc.

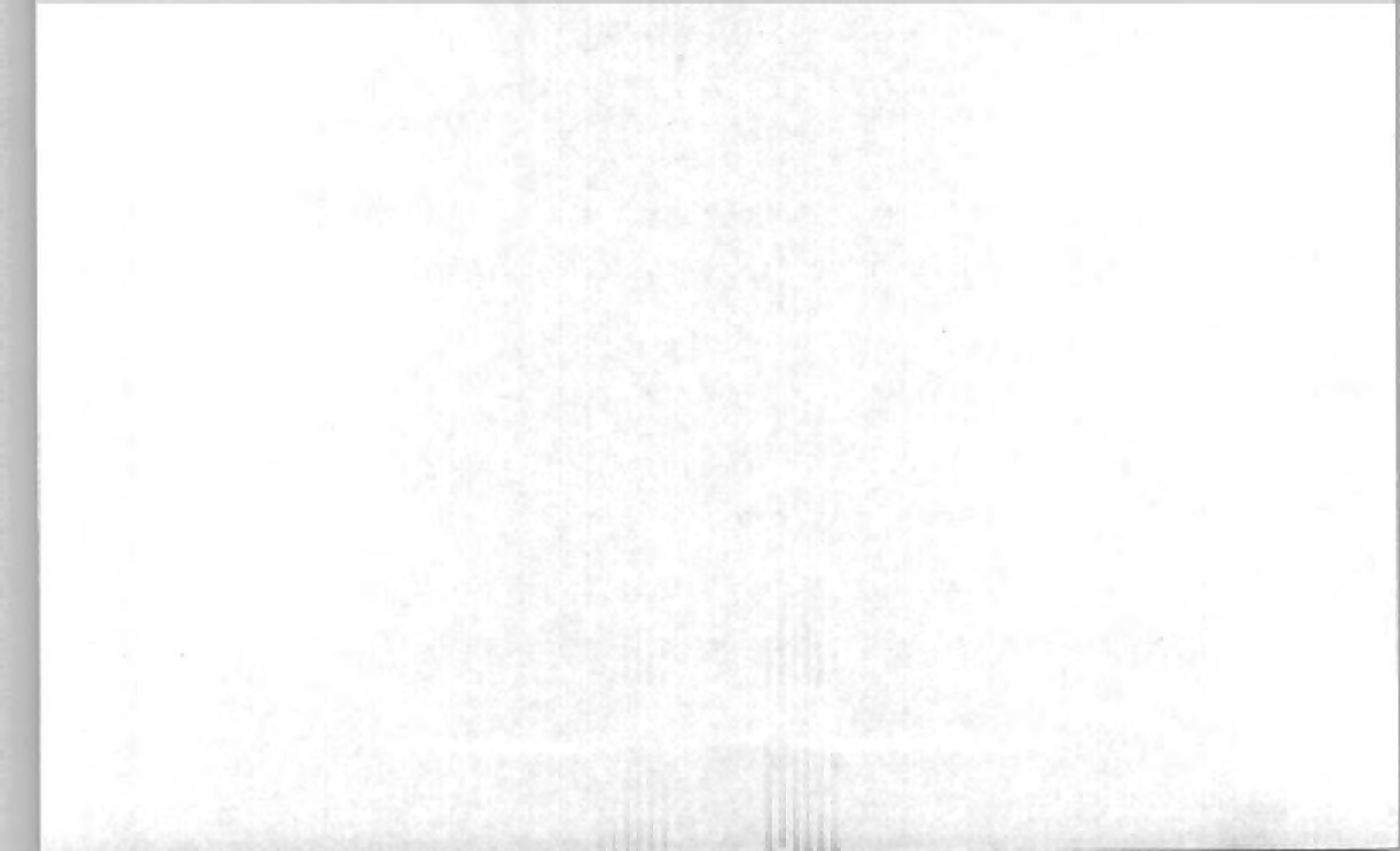

Index No. A-1
(Alphabetical - Numerical)

LAND CORNER RECORD
(RECTANGULAR SURVEYS)

R9-7150-4 (Rev. 6/13/67)
 GPO 802-127

T. 148 R. 26 Mer. N.F. CHIPPEWA County ITASCA State MN
CLOSING COR. Corner common to sections 1 and 6

EXISTING SURVEYS

Original Government Survey	
Year surveyed	<u>1875 B.C. BALDWIN</u>
Original monument	<u>WOOD POST</u> <small>(Wood post, stone, pile of stones, pipe, etc.)</small>
Bearing Trees	
Species	<u>TAM STUB</u> <u>TAM STUB</u>
Diameter	<u>12</u> <u>8</u>
Bearing	<u>S48W</u> <u>S75E</u>
Distance	<u>138 LKS.</u> <u>131 LKS.</u> <u>91.1'</u> <u>86.5'</u>

Subsequent Corner Restoration	
Year surveyed	By
Where filed or recorded	
Monument <small>(Original, concrete post, iron rod, etc.)</small>	

Bearing Trees, Reference Objects	
Species	
Diameter	
Bearing	
Distance	

Original Evidence Found	
Year of search	<u>1937</u> By <u>WALT HABERLE</u>
Monument found	<u>NONE FOUND</u> <u>EST. APPROX.</u>
Original Bearing Trees Found	
Species	<u>POT ESLP ON SPRUCE 10"</u>
Diameter	<u>N80W 4 LKS.</u>
Bearing	<u>OR</u>
Distance	<u>SPRUCE 8" N75W 7 LKS.</u>

Evidence of Subsequent Corner Restoration Found	
Year of search	<u>11/26/90</u> By <u>GF-AH-CK</u>
<u>CHAINED 890' WEST OF APPROX. LOCATION OF STA. TSP COR. - FALLS AT SW EDGE OF BLK. SPRUCE STAND TO N+NE - NO TAG FOUND - FD. SPRUCE STUB 10" DA, 40" HIGH WITH FLAT BLAZE AND AXE MARKS</u>	

Bearing Trees, Reference Objects	
<u>OVER</u>	
<u>SPRUCE STUB BLAZED AREA</u>	
<u>WOULD BE RIGHT HIEGHT FOR</u>	
<u>A BT ALSO FLAT ARED WOULD</u>	
<u>HOLD SCRIBE</u>	

T149N 36 31

R26W

T148N

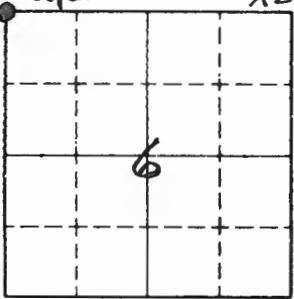

Sketch

○ Corner ▨ F.S. Land

Relation of Evidence to Record Features Along Section Lines

Section line to sections _____

Object _____

Record distance _____

Measured distance _____

Other Evidence

Describe evidence of use and occupation such as roads, fences, clearings, timber cutting lines, plantations, etc.. Cite source of testimony if any. _____

WHICH FACE SOUTH - BOTH ORIG. B.T.'S. WOULD FACE
 NE + NW - NO OTHER EVIDENCE WAS FOUND AT
 THIS TIME - SWAMP GRASS WITH MANY STUMPS CUTOFF
 AROUND AREA - ED. SOME OLD BLAZES ALONG LINE
 RUN WEST TO THIS LOCATION
 COULD CHAIN UP FROM SOUTH SOMETIME AND CHECK LOCATION

At time of search:

1. Did you have the record description?
Yes No _____

2. How was search area located?
Pacing, chaining, photos, maps,
etc. _____

3. Man hours spent in search 1 1/2 HRS.

4. Do you think additional search might
recover evidence? Yes _____ No _____

5. Signature Curt Kramer

Perpetuation Record

Monument and accessories established. Include brief description of area.
NO TAG PUT UP NOW

Certified corner restoration certificate prepared: Yes _____ No _____

Filed in county records at _____ Date _____ County Document No. _____

Identified on aerial photo No. _____ Which is filed at _____

Index No. A-1
(Alphabetical - Numerical)

LAND CORNER RECORD
(RECTANGULAR SURVEYS)

RS-7 150-4 (Rev. 6/13/67)
GPO 802-127

T. 148 R. 26 S. 5 Mer. N.F. CHIPPEWA County ITASCA State MN
CLOSING COR. Corner common to sections 1 and 6

EXISTING SURVEYS

Original Government Survey

Year surveyed 1875 B.C. BALDWIN
Original monument WOOD POST
(Wood post, stone, pile of stones, pipe, etc.)

Bearing Trees

Species	<u>TAM. STUB</u>	<u>TAM STUB</u>
Diameter	<u>12</u>	<u>8</u>
Bearing	<u>S48W</u>	<u>S75E</u>
Distance	<u>91.1'</u>	<u>131 LKS.</u>
	<u>138 LKS.</u>	<u>86.5'</u>

Subsequent Corner Restoration

Year surveyed _____ By _____
Where filed or recorded _____
Monument _____
(Original, concrete post, iron rod, etc.)

Bearing Trees, Reference Objects

Species	_____
Diameter	_____
Bearing	_____
Distance	_____

Original Evidence Found

Year of search _____ By _____
Monument found _____

Original Bearing Trees Found

Species	_____
Diameter	_____
Bearing	_____
Distance	_____

Evidence of Subsequent Corner Restoration Found

Year of search 11-28-90 By GF-MH-CK
CHAINED N2W FROM APPROX. WEST 1/4 COR.
(OLD TAG) TO CLOSING COR. LOCATION

Bearing Trees, Reference Objects

Species	_____
Diameter	_____
Bearing	_____
Distance	_____

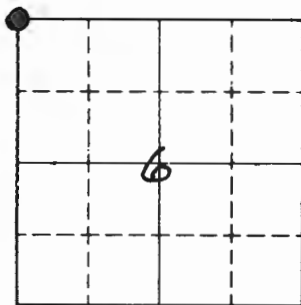

Sketch

○ Corner F.S. Land

Relation of Evidence to Record Features Along Section Lines

Section line to sections _____
 Object _____
 Record distance _____
 Measured distance _____

Other Evidence

Describe evidence of use and occupation such as roads, fences, clearings, timber cutting lines, plantations, etc.. Cite source of testimony if any. _____

RECORDED IN T148N R27W SEC. 1
 HABERLE 1937 SPRUCE 10 N80W 4 LKS. 2.64' WT.
 " " RECORDED IN T148N R26W SEC. 6
 SPRUCE 8 N75W 7 LKS. 4.62' WT.

At time of search:

1. Did you have the record description?

Yes _____ No _____

2. How was search area located?

Pacing, chaining, photos, maps,
 etc. _____

3. Man hours spent in search _____

4. Do you think additional search might
 recover evidence? Yes _____ No _____

5. Signature _____

Perpetuation Record

Monument and accessories established. Include brief description of area. _____

Certified corner restoration certificate prepared: Yes _____ No _____

Filed in county records of _____ Date _____ County Document No. _____

Identified on aerial photo No. _____ Which is filed at _____

T. 148 N R. 26 W Mer. N.F. Chippewa County Itasca State Minnesota
CC-302 Corner common to sections 1 / 2

EXISTING SURVEYS

Original Government Survey

Year surveyed _____
 Original monument _____
(Wood post, stone, pile of stones, pipe, etc.)

Bearing Trees

Species _____
 Diameter _____
 Bearing _____
 Distance _____

Subsequent Corner Restoration

Year surveyed 1962 By U.S.F.S.
 Where filed or recorded _____
 Monument 2" x 5" Iron pipe w/ Brass Cap.
(Original, concrete post, iron rod, etc.)

Bearing Trees, Reference Objects

Species	W. Spruce	Aspen	Steel Post
Diameter	9"	9"	6'
Bearing	S20W	S74E	East
Distance	119.2	15.2	4.68'

Original Evidence Found

Year of search _____ By _____
 Monument found _____

Original Bearing Trees Found

Species _____
 Diameter _____
 Bearing _____
 Distance _____

Evidence of Subsequent Corner Restoration Found

Year of search 1962 By A. J. Hanson
 Monument in place

Bearing Trees, Reference Objects

Species	W. Spruce	Aspen	Steel post
Diameter	10"	12"	6'
Bearing	S20W	S74E	East
Distance	119.2'	15.2'	4.68'

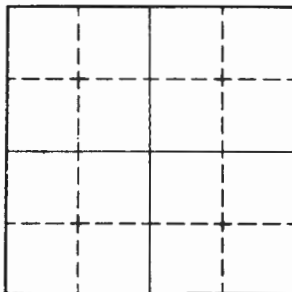

Sketch

Corner F.S. Land

Relation of Evidence to Record Features Along Section Lines

Section line to sections _____
Object _____
Record distance _____
Measured distance _____

Other Evidence

Describe evidence of use and occupation such as roads, fences, clearings, timber cutting lines, plantations, etc.. Cite source of testimony if any. _____

At time of search:

1. Did you have the record description?

Yes _____ No _____

2. How was search area located?

Pacing, chaining, photos, maps, etc. _____

3. Man hours spent in search _____

4. Do you think additional search might recover evidence? Yes _____ No _____

5. Signature _____

Perpetuation Record

Monument and accessories established. Include brief description of area. _____

Foot New BT
Birch steel post
4" 8"
S20E South
12.62 3.0'
SI BT

5/27/80
Monument

Certified corner restoration certificate prepared: Yes _____ No _____

Filed in county records at _____ Date _____ County Document No. _____

Identified on aerial photo No. _____ Which is filed at _____

T. 148 N. R. 26 W. Mer. N.F. Chippewa. County Itasca State Minnesota
West 1/4 Closing Corner common to sections 1 and _____

EXISTING SURVEYS

Original Government Survey

Year surveyed _____

Original monument _____
(Wood post, stone, pile of stones, pipe, etc.)

Bearing Trees

Species _____

Diameter _____

Bearing _____

Distance _____

Subsequent Corner Restoration

Year surveyed 1962 By U.S. F.S.

Where filed or recorded _____

Monument 2" X 5" Iron pipe w/ Brass Cap.
(Original, concrete post, iron rod, etc.)

Bearing Trees, Reference Objects

Species Birch Boulder Steel PostDiameter 8" 3.0 X 2.0 X 1.0" 6"Bearing S39 1/2 W S26 E N88 EDistance 9.45' 64.1' 4.3'

Original Evidence Found

Year of search _____ By _____

Monument found _____

Original Bearing Trees Found

Species _____

Diameter _____

Bearing _____

Distance _____

Evidence of Subsequent Corner Restoration Found

Year of search 1962 By U.S. F.S.Monument in place.

Bearing Trees, Reference Objects

Species Birch Boulder Steel PostDiameter 11" 3" X 2" X 1" 6"Bearing S39 1/2 W S26 E N88 EDistance 9.45' 64.1' 4.3'

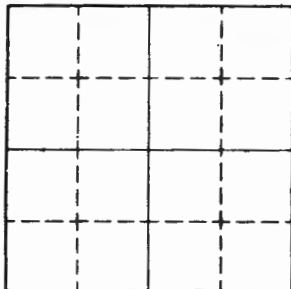

Sketch

Corner F.S. Land

Relation of Evidence to Record Features Along Section Lines

Section line to sections _____

Object _____

Record distance _____

Measured distance _____

Other Evidence

Describe evidence of use and occupation such as roads, fences, clearings, timber cutting lines, plantations, etc.. Cite source of testimony if any. _____

At time of search:

1. Did you have the record description?

Yes _____ No _____

2. How was search area located?

Pacing, chaining, photos, maps, etc. _____

3. Man hours spent in search _____

4. Do you think additional search might recover evidence? Yes _____ No _____

5. Signature _____

Perpetuation Record

Monument and accessories established. Include brief description of area. _____

To perpetuate this cov F cut New BT

*Birch
7"*

584E

27.1

11-5'

15'

5/27/40

Certified corner restoration certificate prepared: Yes _____ No _____

Filed in county records at _____ Date _____ County Document No. _____

Identified on aerial photo No. _____ Which is filed at _____

T. 148N R. 26W 5th Mer. N.F. Chippewa County Itasca State Minnesota
Closing 1/4 Corner common to sections 1 and _____

EXISTING SURVEYS

Original Government Survey

Year surveyed _____
 Original monument _____
(Wood post, stone, pile of stones, pipe, etc.)

Bearing Trees

Species _____
 Diameter _____
 Bearing _____
 Distance _____

Subsequent Corner Restoration

Year surveyed 1963 By U.S. F.S.
 Where filed or recorded _____
 Monument 2" x 5" Iron pipe w/ Brass Cap.
(Original, concrete post, iron rod, etc.)

Bearing Trees, Reference Objects

Species	<u>Cedar</u>	<u>Cedar</u>	<u>Steel Post</u>
Diameter	<u>6"</u>	<u>11"</u>	<u>6"</u>
Bearing	<u>S13E</u>	<u>S58W</u>	<u>West</u>
Distance	<u>38.8'</u>	<u>15.8'</u>	<u>4.7'</u>

Original Evidence Found

Year of search _____ By _____
 Monument found _____

Original Bearing Trees Found

Species _____
 Diameter _____
 Bearing _____
 Distance _____

Evidence of Subsequent Corner Restoration Found

Year of search 1980 By R. G. ...
2" Iron Monument w/ cap in place

Bearing Trees, Reference Objects

Species	<u>Cedar</u>	<u>Down Cedar</u>	<u>Steel post</u>
Diameter	<u>7"</u>	<u>12"</u>	<u>6"</u>
Bearing	<u>S13E</u>	<u>S58W</u>	<u>West</u>
Distance	<u>38.8'</u>	<u>15.8'</u>	<u>4.7'</u>

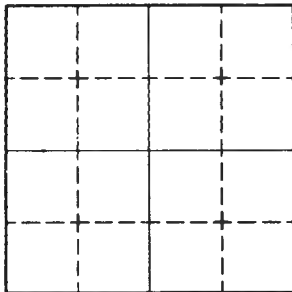

Sketch

○ Corner ▨ F.S. Land

Relation of Evidence to Record Features Along Section Lines

Section line to sections _____
 Object _____
 Record distance _____
 Measured distance _____

Other Evidence

Describe evidence of use and occupation such as roads, fences, clearings, timber cutting lines, plantations, etc.. Cite source of testimony if any. _____

At time of search:

1. Did you have the record description?
 Yes _____ No _____

2. How was search area located?
 Pacing, chaining, photos, maps,
 etc. _____

3. Man hours spent in search _____

4. Do you think additional search might
 recover evidence? Yes _____ No _____

5. Signature _____

Perpetuation Record

Monument and accessories established. Include brief description of area.

To perpetuate this Cor & cut New BT²

*Asd Ash
 4" 9"*

57E 56W

23.8 25.1

*1/4 S 1 1/4 S 1
 BT A*

Certified corner restoration certificate prepared: Yes _____ No _____

Filed in county records at _____ Date _____ County Document No. _____

Identified on aerial photo No. _____ Which is filed at _____

*5/27/80
 K
 H C*

Index No. A-24-25

LAND CORNER RECORD
(RECTANGULAR SURVEYS)

RD-7150-4 (Rev. 6/13/67)

5.0

GPO 502-122

T. 1 N. R. 26

5^{1/2}

Mer. N.F. Chippewa County Itasca

Minnesota

MC Westside Corner common to sections 36

EXISTING SURVEYS

Original Government Survey

Year surveyed _____

Original monument _____
(Wood post, stone, pile of stones, pipe, etc.)

Bearing Trees

Species _____

Diameter _____

Bearing _____

Distance _____

Original Evidence Found

Year of search _____ By _____

Monument found _____

Original Bearing Trees Found

Species _____

Diameter _____

Bearing _____

Distance _____

Subsequent Corner Restoration

Year surveyed 1921 By Itasca County

Where filed or recorded Itasca County Court House

Monument Iron Pipe
(Original, concrete post, iron rod, etc.)

Bearing Trees, Reference Objects

Species Balsam Poplar

Diameter 10" 8"

Bearing N24W S70°W

Distance 36.7' 11.5'

Evidence of Subsequent Corner Restoration Found

Year of search 1980 By R. Olson

found Iron in place by Running
lines to the point from Sec 36
18 the 1/2 & 5/8 of Clearing
1980

Bearing Trees, Reference Objects

Stump hole Batten Stump

N28W S76W

36.7' 11.5'

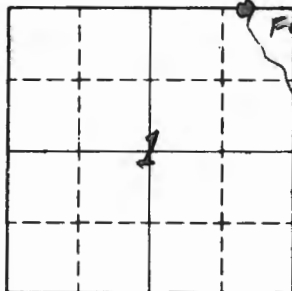

Sketch

○ Corner ▨ F.S. Land

Relation of Evidence to Record Features Along Section Lines

Section line to sections _____
 Object _____
 Record distance _____
 Measured distance _____

Other Evidence

Describe evidence of use and occupation such as roads, fences, clearings, timber cutting lines, plantations, etc.. Cite source of testimony if any. _____

At time of search:

1. Did you have the record description?

Yes _____ No _____

2. How was search area located?

Pacing, chaining, photos, maps, etc. _____

3. Man hours spent in search _____

4. Do you think additional search might recover evidence? Yes _____ No _____

5. Signature _____

3/27/80
 Ronald K. Olson

Perpetuation Record

Monument and accessories established. Include brief description of area.

To perpetuate this Cor. I set a 2" x 5" Long Gal Iron pipe with Brass Cap Marked from which bears

Birch	Ash	Ash	8' steel Post
9"	8"	9"	with sign
N63W	S89W	S58W	West
42.60'	13.2'	40.75'	6.2'
MCS38WT	MCS1RT	MCS1BT	

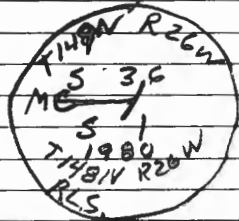

Certified corner restoration certificate prepared: Yes _____ No _____
 Filed in county records at _____ Date _____ County Document No. _____
 Identified on aerial photo No. _____ Which is filed at _____

Index No. B-1
(Alphabetical - Numerical)

LAND CORNER RECORD
(RECTANGULAR SURVEYS)

RD-7150-4 (Rev. 6/13/67)
 GPD 802-127

T. 148 R. 26 Mer. N.F. CHIPPEWA County ITASCA State MN.
NORTH 1/16 Corner common to sections 1 and 6
GOV'T LOTS #546

EXISTING SURVEYS

Original Government Survey	Original Evidence Found
Year surveyed _____	Year of search _____ By _____
Original monument _____ <small>(Wood post, stone, pile of stones, pipe, etc.)</small>	Monument found _____
Bearing Trees	Original Bearing Trees Found
Species _____	Species _____
Diameter _____	Diameter _____
Bearing _____	Bearing _____
Distance _____	Distance _____
Subsequent Corner Restoration	Evidence of Subsequent Corner Restoration Found
Year surveyed <u>1937</u> By <u>WALT HABERLE</u>	Year of search <u>11-28-90</u> By <u>GF-RM-CK</u>
Where filed or recorded <u>OLD CCC BK 148-2B # 196</u>	<u>CHAINED 1353' AT NZW FROM APPROX. W/4</u>
Monument <u>NONE STATED</u> <small>(Original, concrete post, iron rod, etc.)</small>	<u>SEC. 6 - OUR LINE IS APPROX. 40' EAST OF</u>
<u>20.50 CHS NORTH OF 1/4 COR. - 1353'</u>	<u>OLD TAG ON A 10" BASSWOOD BY CCC'S</u>
<u>PUT FSLP ON - WITNESS TREE</u>	<u>CONTINUE LINE NZW TO APPROX. C.C.</u>
Bearing Trees, Reference Objects	Bearing Trees, Reference Objects
Species <u>B. WOOD</u>	_____
Diameter <u>4</u>	_____
Bearing <u>N76W</u>	_____
Distance <u>3 LKS.</u>	_____
<u>1.98'</u>	_____

CCC'S DISTANCE
5346'

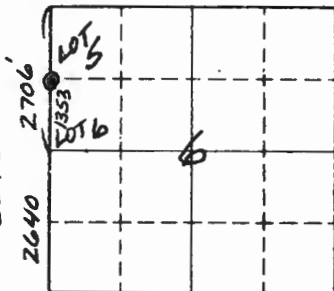

Sketch

○ Corner ▨ F.S. Land

Relation of Evidence to Record Features Along Section Lines

Section line to sections	_____	_____	_____	_____
Object	_____	_____	_____	_____
Record distance	_____	_____	_____	_____
Measured distance	_____	_____	_____	_____

Other Evidence

Describe evidence of use and occupation such as roads, fences, clearings, timber cutting lines, plantations, etc.. Cite source of testimony if any. _____

At time of search:

1. Did you have the record description?

Yes No _____

2. How was search area located?

Pacing, shaining photos, maps, etc. _____

3. Man hours spent in search _____

4. Do you think additional search might recover evidence? Yes _____ No _____

5. Signature Curt Krause

Perpetuation Record

Monument and accessories established. Include brief description of area. _____

Certified corner restoration certificate prepared: Yes _____ No _____

Filed in county records at _____ Date _____ County Document No. _____

Identified on aerial photo No. _____ Which is filed at _____

T. 148N R. 26W Mer. N.F. Chippewa County Itasca State Minnesota
North 1/16 Corner common to sections 1 & 2

EXISTING SURVEYS

Original Government Survey

Year surveyed _____

Original monument _____
(Wood post, stone, pile of stones, pipe, etc.)

Bearing Trees

Species _____

Diameter _____

Bearing _____

Distance _____

Subsequent Corner Restoration

Year surveyed 1962 By U.S.F.S.

Where filed or recorded _____

Monument 2" x 5" Iron pipe w/ Brass Cap
(Original, concrete post, iron rod, etc.)

Bearing Trees, Reference Objects

Species W. Spruce W. SpruceDiameter 8" 4"Bearing S15W N70WDistance 23.9' 42.0'

Original Evidence Found

Year of search _____ By _____

Monument found _____

Original Bearing Trees Found

Species _____

Diameter _____

Bearing _____

Distance _____

Evidence of Subsequent Corner Restoration Found

Year of search 1980 By R. OlesonMonument in place

Bearing Trees, Reference Objects

Species W. Spruce W. Spruce Steel postDiameter 9" 7" 6"Bearing S15W N70W EastDistance 23.9' 42.0' 4.6'

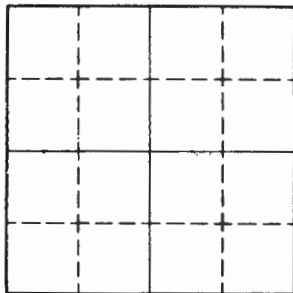

Sketch

○ Corner ▨ F.S. Land

Relation of Evidence to Record Features Along Section Lines

Section line to sections _____
 Object _____
 Record distance _____
 Measured distance _____

Other Evidence

Describe evidence of use and occupation such as roads, fences, clearings, timber cutting lines, plantations, etc.. Cite source of testimony if any. _____

At time of search:

1. Did you have the record description?

Yes _____ No _____

2. How was search area located?

Pacing, chaining, photos, maps,
 etc. _____

3. Man hours spent in search _____

4. Do you think additional search might
 recover evidence? Yes _____ No _____

5. Signature _____

Perpetuation Record

Monument and accessories established. Include brief description of area. _____

I cut New BT

Birch

6"

555 E

7.92

1/16 S1

BT

5/21/80
Handwritten signature

Certified corner restoration certificate prepared: Yes _____ No _____

Filed in county records at _____ Date _____ County Document No. _____

Identified on aerial photo No. _____ Which is filed at _____

Index No. B-22
(Alphabetical - Numerical)Leaf # 1
Page # 13LAND CORNER RECORD
(RECTANGULAR SURVEYS)R9-7150-4 (Rev. 6/13/67)
GPO 802-127

5.0.

T. 148 N R. 26 W 5th Mer. N.F. Chippewa County Itasca State Minnesota
North West 1/4 Corner common to sections 1 and _____

EXISTING SURVEYS

Original Government Survey

Year surveyed _____
Original monument _____
(Wood post, stone, pile of stones, pipe, etc.)

Bearing Trees

Species _____
Diameter _____
Bearing _____
Distance _____

Subsequent Corner Restoration

Year surveyed 1963 By U. S. F.S.
Where filed or recorded _____
Monument 2" x 3" Iron pipe w/ Brass Cap
(Original, concrete post, iron rod, etc.)

Bearing Trees, Reference Objects

Species Elm W. Spruce Boulder
Diameter 7" 2" 2' x 3'
Bearing S63E N49W N21W
Distance 51.5 48.6' 18.3

Original Evidence Found

Year of search _____ By _____
Monument found _____

Original Bearing Trees Found

Species _____
Diameter _____
Bearing _____
Distance _____

Evidence of Subsequent Corner Restoration Found

Year of search 1980 By M. V. S.
Monument in place

Bearing Trees, Reference Objects

Species Elm W. Spruce Boulder Steel post
Diameter 7" 8" 2' x 3' 6"
Bearing S63E N49W N21W West
Distance 51.5 48.6' 18.3' 4.8

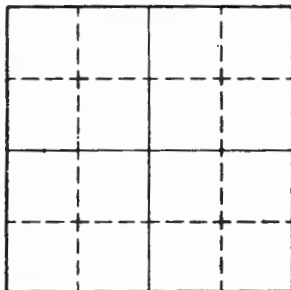

Sketch

Corner F.S. Land

Relation of Evidence to Record Features Along Section Lines

Section line to sections _____
Object _____
Record distance _____
Measured distance _____

Other Evidence

Describe evidence of use and occupation such as roads, fences, clearings, timber cutting lines, plantations, etc.. Cite source of testimony if any. _____

At time of search:

1. Did you have the record description?

Yes _____ No _____

2. How was search area located?

Pacing, chaining, photos, maps, etc. _____

3. Man hours spent in search _____

4. Do you think additional search might recover evidence? Yes _____ No _____

5. Signature _____

Perpetuation Record

Monument and accessories established. Include brief description of area. _____

set steel post 8' long South 2.4'
w/signs 54-2 & 54-4

5/27/80
final OK

Certified corner restoration certificate prepared: Yes _____ No _____

Filed in county records at _____ Date _____ County Document No. _____

Identified on aerial photo No. _____ Which is filed at _____

Index No. C-1
(Alphabetical - Numerical)

LAND CORNER RECORD
(RECTANGULAR SURVEYS)

RR-7150-4 (Rev. 6/13/67)
 GPO 802-127

T. 148 R. 26 5 Mer. N.F. CHIPPEWA County ITASCA State MN.
WEST 1/4 Corner common to sections _____ and 6

EXISTING SURVEYS

Original Government Survey

Year surveyed 1875 B. C. BALDWIN
 Original monument WOOD POST
(Wood post, stone, pile of stones, pipe, etc.)

Bearing Trees

Species	<u>TAM</u>	<u>TAM</u>
Diameter	<u>5</u>	<u>5</u>
Bearing	<u>N47E</u>	<u>S45W</u>
Distance	<u>12 LKS.</u>	<u>30 LKS.</u>
	<u>7.9'</u>	<u>19.8'</u>

Subsequent Corner Restoration

Year surveyed 6/25/35 By EMMERT
 Where filed or recorded _____
 Monument SET NEW POST
(Original, concrete post, iron rod, etc.)

FD. TAM 8" N85E 105 LKS. = 69.3'
MKD 1/4 S BT

FSLP Bearing Trees, Reference Objects OVER

Species	<u>SPRUCE</u>	<u>ANOTHER FSLP</u>
Diameter	<u>5</u>	
Bearing	<u>SIW</u>	
Distance	<u>21 LKS.</u>	
	<u>13.9'</u>	

Original Evidence Found

Year of search _____ By _____
 Monument found _____

Original Bearing Trees Found

Species	_____	_____
Diameter	_____	_____
Bearing	_____	_____
Distance	_____	_____

Evidence of Subsequent Corner Restoration Found

Year of search 11-28-90 By RM-GF-CK
CHAINED NORTH FROM SW COR. SEC. 6
2600' N - THEN 104' E TO OLD CCC TAG ON
SPRUCE SNAG 10' HIGH - TAG ON SOUTH SIDE
WE PULL DISTANCE OF 13.9' AT S6°W AND
SEARCH AREA FOR OLD POST

Bearing Trees, Reference Objects OVER

_____	_____	_____
_____	_____	_____
_____	_____	_____
_____	_____	_____

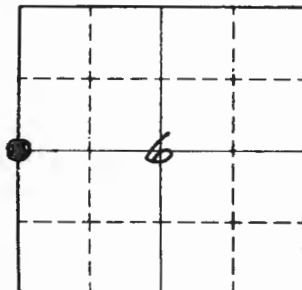

Sketch

○ Corner F.S. Land

Relation of Evidence to Record Features Along Section Lines

Section line to sections _____
 Object _____
 Record distance _____
 Measured distance _____

Other Evidence

Describe evidence of use and occupation such as roads, fences, clearings, timber cutting lines, plantations, etc.. Cite source of testimony if any. _____

874 By W. HABERLE

TAG ON TAM 6 N30W 11 LKS. = 7.26'

NO EVIDENCE COULD BE LOCATED AT THIS TIME

NO POST-NO BT'S.

CONTINUE LINE N2W

At time of search:

1. Did you have the record description?

Yes No _____

2. How was search area located?

Pacing chaining, photos, maps, etc. _____

3. Man hours spent in search _____

4. Do you think additional search might recover evidence? Yes _____ No _____

5. Signature Curt Krause

Perpetuation Record

Monument and accessories, established. Include brief description of area. _____

SET 2" X 5' TAM STAKE AS APPROX. COR.

SPRICE STUB 7" N6E 13.9'

CEDAR 4 S62E 33.75'

CEDAR 6 N14W 21.93'

TAM 3 S49W 14.34

SHOULD SEARCH IN SUMMER - ~~NO~~ NOW FROZEN

AND SNOW COVER

Certified corner restoration certificate prepared: Yes _____ No _____

Filed in county records at _____ Date _____ County Document No. _____

Identified on aerial photo No. _____ Which is filed at _____

T. 148N R. 26W Mer. N.F. Chippewa County Itasca State Minnesota
1/4 Corner common to sections 1 & 2 and _____

EXISTING SURVEYS

Original Government Survey

Year surveyed _____

Original monument _____
(Wood post, stone, pile of stones, pipe, etc.)

Bearing Trees

Species _____

Diameter _____

Bearing _____

Distance _____

Original Evidence Found

Year of search _____ By _____

Monument found _____

Original Bearing Trees Found

Species _____

Diameter _____

Bearing _____

Distance _____

Subsequent Corner Restoration

Year surveyed 1962 By U.S.F.S.

Where filed or recorded _____

Monument 2"x5" Iron pipe w/Brass Cap
(Original, concrete post, iron rod, etc.)

Evidence of Subsequent Corner Restoration Found

Year of search 1980 By R. Olson

Monument in place

Bearing Trees, Reference Objects

Species	<u>W. Spruce</u>	<u>W. Spruce</u>	<u>Steel Post</u>
Diameter	<u>4"</u>	<u>4"</u>	<u>6"</u>
Bearing	<u>N30E</u>	<u>S29W</u>	<u>W45E</u>
Distance	<u>12.5'</u>	<u>21.45'</u>	<u>3.9'</u>

Bearing Trees, Reference Objects

Species	<u>W. Spruce</u>	<u>W. Spruce</u>	<u>Steel post</u>
Diameter	<u>6"</u>	<u>10"</u>	<u>6"</u>
Bearing	<u>N30E</u>	<u>S29W</u>	<u>W45E</u>
Distance	<u>12.5'</u>	<u>21.45'</u>	<u>3.9'</u>

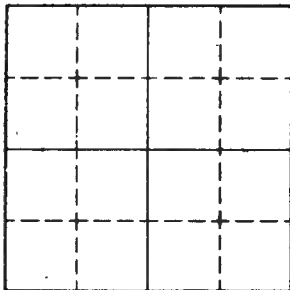

Sketch

Corner F.S. Land

Relation of Evidence to Record Features Along Section Lines

Section line to sections _____

Object _____

Record distance _____

Measured distance _____

Other Evidence

Describe evidence of use and occupation such as roads, fences, clearings, timber cutting lines, plantations, etc.. Cite source of testimony if any. _____

At time of search:

1. Did you have the record description?

Yes _____ No _____

2. How was search area located?

Pacing, chaining, photos, maps, etc. _____

3. Man hours spent in search _____

4. Do you think additional search might recover evidence? Yes _____ No _____

5. Signature _____

Perpetuation Record

Monument and accessories established. Include brief description of area. _____

ECUT New BT

*NSpruce Steel post
6" 8"*

*575E EAST
35.10' 10.6'*

*1/4 S1
BT*

*5/27/80
Revised*

Certified corner restoration certificate prepared: Yes _____ No _____

Filed in county records at _____ Date _____ County Document No. _____

Identified on aerial photo No. _____ Which is filed at _____

Index No. C-22
(Alphabetical - Numerical)Book #1
Page #14LAND CORNER RECORD
(RECTANGULAR SURVEYS)R9-7150-4 (Rev. 6/13/67)
GPO 802-127T. 148 N. R. 26 W 5th Mer. N.F. Chippewa County Itasca State Minnesota
Center West 1/16 Corner common to sections 11 and _____

EXISTING SURVEYS

Original Government Survey

Year surveyed _____

Original monument _____
(Wood post, stone, pile of stones, pipe, etc.)

Bearing Trees

Species _____

Diameter _____

Bearing _____

Distance _____

Subsequent Corner Restoration

Year surveyed 1963 By U.S. F.S.

Where filed or recorded _____

Monument 2" x 5" Iron pipe w/ Brass cap
(Original, concrete post, iron rod, etc.)

Bearing Trees, Reference Objects

Species Ash Ash Steel PostDiameter 6" 7" 6"Bearing N58E S9E WestDistance 17.9 24.3 5.3'

Original Evidence Found

Year of search _____ By _____

Monument found _____

Original Bearing Trees Found

Species _____

Diameter _____

Bearing _____

Distance _____

Evidence of Subsequent Corner Restoration Found

Year of search 1980 By _____

Where filed or recorded _____

Monument in place

Bearing Trees, Reference Objects

Species Ash Ash Steel postDiameter 8" 8" 6"Bearing N58E S9E WestDistance 17.9 24.3 5.3'

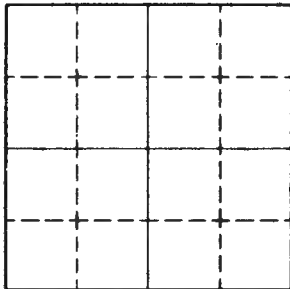

Sketch

○ Corner ▨ F.S. Land

Relation of Evidence to Record Features Along Section Lines

Section line to sections _____
 Object _____
 Record distance _____
 Measured distance _____

Other Evidence

Describe evidence of use and occupation such as roads, fences, clearings, timber cutting lines, plantations, etc.. Cite source of testimony if any. _____

At time of search:

1. Did you have the record description?

Yes _____ No _____

2. How was search area located?

Pacing, chaining, photos, maps, etc. _____

3. Man hours spent in search _____

4. Do you think additional search might recover evidence? Yes _____ No _____

5. Signature _____

Perpetuation Record

Monument and accessories established. Include brief description of area. _____

2' Cot now RT.

Casswood Steel post
4" 8"

N54W North
24.33 3.1'
CW 11651 W/S 945
RT 54-2954-4

5/27/80
Remnant C

Certified corner restoration certificate prepared: Yes _____ No _____

Filed in county records at _____ Date _____ County Document No. _____

Identified on aerial photo No. _____ Which is filed at _____

Index No. D-21
(Alphabetical-Numerical)

*Book #1
Page #167
5th*

LAND CORNER RECORD
(RECTANGULAR SURVEYS)

X9-7150-4 (Rev. 6/13/67)
GPO 502-127

T. 148 N R. 26 W
S 1/4

Mer. N.F. CHIPPewa County

State Mn

Corner common to sections 1 and 2

EXISTING SURVEYS

Original Government Survey

Year surveyed _____
Original monument _____
(Wood post, stone, pile of stones, pipe, etc.)

Bearing Trees

Species _____
Diameter _____
Bearing _____
Distance _____

Subsequent Corner Restoration

Year surveyed 1962 By D.S.P.S.
Where filed or recorded _____
Monument 2" x 5" Iron pipe w/ Brass cap
(Original, concrete post, iron rod, etc.)

Bearing Trees, Reference Objects

Species Cedar Cedar Steel post
Diameter 5" 6" 6"
Bearing S 72 1/2 E S 10 E West
Distance 19.45 38.0' 4.6'

Original Evidence Found

Year of search _____ By _____
Monument found _____

Original Bearing Trees Found

Species _____
Diameter _____
Bearing _____
Distance _____

Evidence of Subsequent Corner Restoration Found

Year of search 1979 By Jim Schoonover
Monument + ATs in
Good Condition

Bearing Trees, Reference Objects

CEGAR CEGAR
8" 9"
S 72 1/2 E S 10 E
19.35' 38.6'

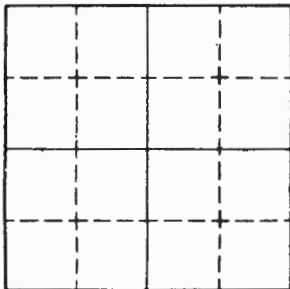

Sketch

Corner F.S. Land

Relation of Evidence to Record Features Along Section Lines

Section line to sections _____
Object _____
Record distance _____
Measured distance _____

Other Evidence

Describe evidence of use and occupation such as roads, fences, clearings, timber cutting lines, plantations, etc.. Cite source of testimony if any. _____

At time of search:

1. Did you have the record description?

Yes _____ No _____

2. How was search area located?

Pacing, chaining, photos, maps,
etc _____

3. Man hours spent in search _____

4. Do you think additional search might
recover evidence? Yes _____ No _____

Perpetuation Record

Monument and accessories established. Include brief description of area. _____

SET STBOL Post with Attention and Boundary
Signs 29' South of Monument

MADE 1BT
BLACK SPRUCE

220W, 29.13'

Certified corner restoration certificate prepared: Yes _____ No _____

Filed in county records at _____ Date _____ County Document No. _____

Identified on aerial photo No. _____ Which is filed at _____

5. Signature _____

Index No. D-27
(Alphabetical - Numerical)

LAND CORNER RECORD
(RECTANGULAR SURVEYS)

RD-7150-4 (Rev. 6/13/67)
GPO 802-127

T. 148 N R. 26 W
SW 1/16

15
5th

Mer. N.F. 141499999 County Itasca State Minnesota

Corner common to sections _____ and _____

County 125 S

EXISTING SURVEYS

Original Government Survey

Year surveyed _____
Original monument _____
(Wood post, iron pipe or stake, pipe, etc.)

Bearing Trees

Species _____
Diameter _____
Bearing _____
Distance _____

Subsequent Corner Restoration

Year surveyed 1924 By Itasca County
Where filed or recorded Itasca Co. Court House
Monument Iron pipe
(Original, concrete slab, etc.)

Bearing Trees, Reference Objects

Species R. Pine R. Pine
Diameter 24" 24"
Bearing S17W N38E
Distance 18.6' 11.3'

Original Evidence Found

Year of search _____ By _____
Monument found _____

Original Bearing Trees Found

Species _____
Diameter _____
Bearing _____
Distance _____

Evidence of Subsequent Corner Restoration Found

Year of search 1924 By R. Olson
found Iron pipe 1" x 24" in place

Bearing Trees, Reference Objects

Pine Stump Pine Stump
24" 24"
S23W N44E
18.6' 11.3'

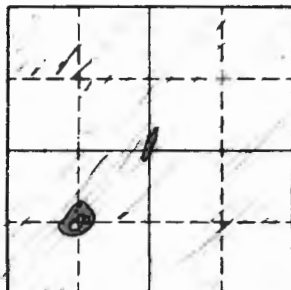

Sketch

○ Corner ▨ F.S. Land

Relation of Evidence to Record Features Along Section Lines

Section line to sections _____
 Object _____
 Record distance _____
 Measured distance _____

Other Evidence

Describe evidence of use and occupation such as roads, fences, clearings, timber cutting lines, plantations, etc.. Cite source of testimony if any. _____

At time of search:

1. Did you have the record description?

Yes _____ No _____

2. How was search area located?

Pacing, chaining, photos, maps, etc. _____

3. Man hours spent in search _____

4. Do you think additional search might recover evidence? Yes _____ No _____

5. Signature _____

Perpetuation Record

Monument and accessories established. Include brief description of area.

To perpetuate this corner I set a 2" x 5' long steel pipe with Brass Cap. Marked.

from which bearings

Elm	Elm	Birch	8' steep part	8' steep part
6°	6	9°		
N15W	S11E	N39E	East	South
23.78	54.73	29.95'	1.8'	1.8'

10/29
 Ronald [Signature]

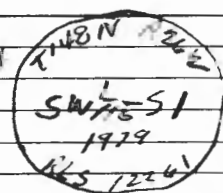

Certified corner restoration certificate prepared: Yes _____ No _____

Filed in county records at _____ Date _____ County Document No. _____

Identified on aerial photo No. _____ Which is filed at _____

Index No. N-23
(Alphabetical - Numerical)

Sheet # 16
Page # 5th

LAND CORNER RECORD
(RECTANGULAR SURVEYS)

RD-7150-4 (Rev. 6/13/67)
GPO 502-127

T. 148 R. 26 Mer. N.E. Chippewa County State MN
Corner common to sections 1 and _____

EXISTING SURVEYS

Original Government Survey

Year surveyed _____

Original monument _____
(Wood post, stone, pile of stones, pipe, etc.)

Bearing Trees

Species _____

Diameter _____

Bearing _____

Distance _____

Original Evidence Found

Year of search _____ By _____

Monument found _____

Original Bearing Trees Found

Species _____

Diameter _____

Bearing _____

Distance _____

Subsequent Corner Restoration

Year surveyed 1962 By U.S.F.S.

Where filed or recorded _____

Monument 2"x5" Iron w/ brass cap.
(Original, concrete post, iron rod, etc.)

Evidence of Subsequent Corner Restoration Found

Year of search 1979 By JIM SCHOENOVER

Monument + BT'S IN
GOOD Condition

Bearing Trees, Reference Objects			
Species	<u>R. Pine</u>	<u>Ash</u>	<u>Maple</u>
Diameter	<u>14"</u>	<u>9"</u>	<u>6"</u>
Bearing	<u>N73W</u>	<u>N70E</u>	<u>S26E</u>
Distance	<u>48.8'</u>	<u>34.85'</u>	<u>16.35'</u>

Bearing Trees, Reference Objects			
Species	<u>R. Pine</u>	<u>Maple</u>	<u>Ash</u>
Diameter	<u>17"</u>	<u>11"</u>	<u>10"</u>
Bearing	<u>N130W</u>	<u>S26E</u>	<u>N70E</u>
Distance	<u>43.8'</u>	<u>16.35'</u>	<u>34.85'</u>

T. 148 N R. 26 W 5th Mer. N.F. Chippewa County Itasca State Minnesota
Sec. 3 Corner common to sections 3, 4, 9 and 10

EXISTING SURVEYS

Original Government Survey

Year surveyed _____

Original monument _____
(Wood post, stone, pile of stones, pipe, etc.)

Bearing Trees

Species _____

Diameter _____

Bearing _____

Distance _____

Original Evidence Found

Year of search _____ By _____

Monument found _____

Original Bearing Trees Found

Species _____

Diameter _____

Bearing _____

Distance _____

Subsequent Corner Restoration

Year surveyed 1962 By U.S.F.S.

Where filed or recorded _____

Monument 2" Iron 5' Long w/ brass cap.
(Original, concrete post, iron rod, etc.)

Evidence of Subsequent Corner Restoration Found

Year of search 1979 By Jim Schaefer

Monument in place

Bearing Trees, Reference Objects

Species	<u>Birch</u>	<u>Cedar</u>	<u>stump</u>	<u>stump</u>
Diameter	<u>4"</u>	<u>8"</u>	<u>6'</u>	<u>6'</u>
Bearing	<u>N34W</u>	<u>S65W</u>	<u>South</u>	<u>East</u>
Distance	<u>18.9'</u>	<u>82.7'</u>	<u>3.55'</u>	<u>4.5'</u>

Bearing Trees, Reference Objects

Species	<u>Birch</u>	<u>Cedar</u>	<u>stump</u>	<u>stump</u>
Diameter	<u>5"</u>	<u>10"</u>	<u>6'</u>	<u>6'</u>
Bearing	<u>N34W</u>	<u>S55W</u>	<u>South</u>	<u>East</u>
Distance	<u>18.9</u>	<u>82.7'</u>	<u>3.2'</u>	<u>4.6'</u>

strips visible 54-2 54-4 54-2 - 54-4

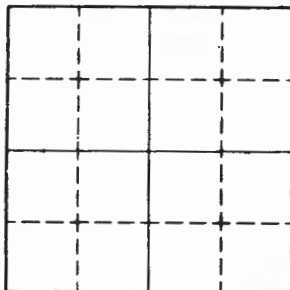

Sketch

Corner F.S. Land

Relation of Evidence to Record Features Along Section Lines

Section line to sections _____

Object _____

Record distance _____

Measured distance _____

Other Evidence

Describe evidence of use and occupation such as roads, fences, clearings, timber cutting lines, plantations, etc.. Cite source of testimony if any. _____

At time of search:

1. Did you have the record description?

Yes _____ No _____

2. How was search area located?

Pacing, chaining, photos, maps, etc. _____

3. Man hours spent in search _____

4. Do you think additional search might recover evidence? Yes _____ No _____

5. Signature _____

Perpetuation Record

Monument and accessories established. Include brief description of area.

*To Arroyo Corner to Standard I cut New
BT²*

<i>Birch</i>	<i>Spruce</i>
<i>4"</i>	<i>4"</i>
<i>N32E</i>	<i>S71E</i>
<i>11.9'</i>	<i>20.82'</i>

*12/4/79
Jim Schoonover
ASO*

Certified corner restoration certificate prepared: Yes _____ No _____

Filed in county records at _____ Date _____ County Document No. _____

Identified on aerial photo No. _____ Which is filed at _____

Index No. E-14
(Alphabetical - Numerical)

*Book #1
- Page #41*

LAND CORNER RECORD
(RECTANGULAR SURVEYS)

K9-7150-4 (Rev. 6/13/67)
GPO 502-127-50

T. 148 N R. 26 W Mer. N.F. CHIPPENAWA County ITASCA State MI
W 1/4 Corner common to sections 3, 10 and _____

EXISTING SURVEYS

Original Government Survey

Year surveyed _____

Original monument _____
(Wood post, stone, pile of stones, pipe, etc.)

Bearing Trees

Species _____

Diameter _____

Bearing _____

Distance _____

Original Evidence Found

Year of search _____ By _____

Monument found _____

Original Bearing Trees Found

Species _____

Diameter _____

Bearing _____

Distance _____

Subsequent Corner Restoration

Year surveyed 1968 By Oberman - U.S.F.S.

Where filed or recorded _____

Monument _____
(Original, concrete post, iron rod, etc.)

Evidence of Subsequent Corner Restoration Found

Year of search 6-28-79 By Jim Ahononen

Monument and BT's in
Good Condition.

Bearing Trees, Reference Objects

Species _____

Diameter _____

Bearing _____

Distance _____

Bearing Trees, Reference Objects

<u>BIRCH</u>	<u>MAPLES</u>	<u>MAPLES</u>
<u>17"</u>	<u>19"</u>	<u>12"</u>
<u>S 02° E</u>	<u>N 22° E</u>	<u>N 30° W</u>
<u>11.8'</u>	<u>12.95'</u>	<u>57.8'</u>

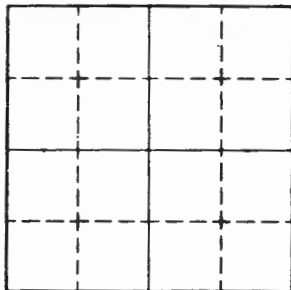

Sketch

○ Corner ▨ F.S. Land

Relation of Evidence to Record Features Along Section Lines

Section line to sections _____

Object _____

Record distance _____

Measured distance _____

Other Evidence

Describe evidence of use and occupation such as roads, fences, clearings, timber cutting lines, plantations, etc.. Cite source of testimony if any. _____

At time of search:

1. Did you have the record description?

Yes _____ No _____

2. How was search area located?

Pacing, chaining, photos, maps, etc. _____

3. Man hours spent in search _____

4. Do you think additional search might recover evidence? Yes _____ No _____

5. Signature _____

Perpetuation Record

Monument and accessories established. Include brief description of area. _____

Certified corner restoration certificate prepared: Yes _____ No _____

Filed in county records at _____ Date _____ County Document No. _____

Identified on aerial photo No. _____ Which is filed at _____

Index No. E-15
(Alphabetical - Numerical)

Book #1
Page #35

LAND CORNER RECORD
(RECTANGULAR SURVEYS)

RD-7150-4 (Rev. 6/13/67) 5.0
GPO 808-127

T. 48N R. 26W STH Mer. N.F. CHIPPewa County ITASCA State MN
Corner common to sections 3, 10 and _____

EXISTING SURVEYS

Original Government Survey

Year surveyed _____
Original monument _____
(Wood post, stone, pile of stones, pipe, etc.)

Bearing Trees

Species _____
Diameter _____
Bearing _____
Distance _____

Subsequent Corner Restoration

Year surveyed 1963 By Cherman - U.S.F.S.
Where filed or recorded _____
Monument _____
(Original, concrete post, iron rod, etc.)

Bearing Trees, Reference Objects

Species _____
Diameter _____
Bearing _____
Distance _____

Original Evidence Found

Year of search _____ By _____
Monument found _____

Original Bearing Trees Found

Species _____
Diameter _____
Bearing _____
Distance _____

Evidence of Subsequent Corner Restoration Found

Year at search 6-14-79 By Jim Schlooson
Found monument 3" ~~below~~
BELOW Road.

Bearing Trees, Reference Objects

Bearing Trees, Reference Objects	Bearing Trees, Reference Objects	Bearing Trees, Reference Objects
<u>MAPLE</u>	<u>Rock</u>	<u>oak</u>
<u>3"</u>	<u>2.0' x 1.5'</u>	<u>No EVIDENCE</u>
<u>N 49° 05'</u>	<u>S 56° E</u>	
<u>43.4'</u>	<u>46.4'</u>	

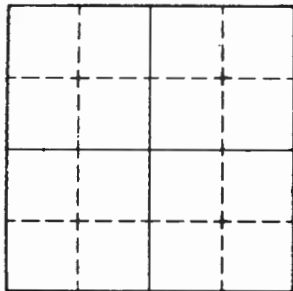

Sketch *

○ Corner ▨ F.S. Land

Relation of Evidence to Record Features Along Section Lines

Section line to sections _____

Object _____

Record distance _____

Measured distance _____

Other Evidence

Describe evidence of use and occupation such as roads, fences, clearings, timber cutting lines, plantations, etc.. Cite source of testimony if any. _____

At time of search:

1. Did you have the record description?

Yes _____ No _____

2. How was search area located?

Pacing, chaining, photos, maps, etc. _____

3. Man hours spent in search _____

4. Do you think additional search might recover evidence? Yes _____ No _____

5. Signature _____

Perpetuation Record

Monument and accessories established. Include brief description of area. _____

*SET STEEL POST WITH ATTENTION
SIGN 15' N. OF MONUMENT.*

Certified corner restoration certificate prepared: Yes _____ No _____

Filed in county records at _____ Date _____ County Document No. _____

Identified on aerial photo No. _____ Which is filed at _____

T. 148N R. 26W STH Mer. N.F. C HIPPEWA County ITASCA State MN
 E Y16 Corner common to sections 3, 10 and _____

EXISTING SURVEYS

Original Government Survey	Original Evidence Found								
Year surveyed _____ Original monument _____ <small>(Wood post, stone, pile of stones, pipe, etc.)</small>	Year of search _____ By _____ Monument found _____								
<p style="text-align: center;">Bearing Trees</p> Species _____ Diameter _____ Bearing _____ Distance _____	<p style="text-align: center;">Original Bearing Trees Found</p> Species _____ Diameter _____ Bearing _____ Distance _____								
<p style="text-align: center;">Subsequent Corner Restoration</p> Year surveyed <u>1963</u> By <u>Cherman - U.S.F.S.</u> Where filed or recorded _____ Monument _____ <small>(Original, concrete post, iron rod, etc.)</small>	<p style="text-align: center;">Evidence of Subsequent Corner Restoration Found</p> Year of search <u>6-20-79</u> By <u>Jim SCHONHAUER</u> <u>Monument and BTs in Good Condition</u>								
<p style="text-align: center;">Bearing Trees, Reference Objects</p> Species _____ Diameter _____ Bearing _____ Distance _____	<p style="text-align: center;">Bearing Trees, Reference Objects</p> <table border="0"> <tr> <td><u>Maple</u></td> <td><u>Maple</u></td> </tr> <tr> <td><u>8"</u></td> <td><u>13'</u></td> </tr> <tr> <td><u>S 75° E</u></td> <td><u>N 72° W</u></td> </tr> <tr> <td><u>31.3'</u></td> <td><u>73.2'</u></td> </tr> </table>	<u>Maple</u>	<u>Maple</u>	<u>8"</u>	<u>13'</u>	<u>S 75° E</u>	<u>N 72° W</u>	<u>31.3'</u>	<u>73.2'</u>
<u>Maple</u>	<u>Maple</u>								
<u>8"</u>	<u>13'</u>								
<u>S 75° E</u>	<u>N 72° W</u>								
<u>31.3'</u>	<u>73.2'</u>								

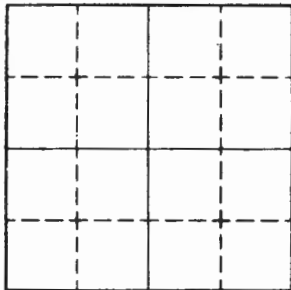

Sketch

○ Corner ▨ F.S. Land

Relation of Evidence to Record Features Along Section Lines

Section line to sections _____

Object _____

Record distance _____

Measured distance _____

Other Evidence

Describe evidence of use and occupation such as roads, fences, clearings, timber cutting lines, plantations, etc.. Cite source of testimony if any. _____

At time of search:

1. Did you have the record description?

Yes _____ No _____

2. How was search area located?

Pacing, chaining, photos, maps, etc. _____

3. Man hours spent in search _____

4. Do you think additional search might recover evidence? Yes _____ No _____

5. Signature _____

Perpetuation Record

Monument and accessories established. Include brief description of area. _____

SET STEEL POST WITH ATTENTION + BOUNDING SIGNS 2.5' EAST OF MONUMENT

Certified corner restoration certificate prepared: Yes _____ No _____

Filed in county records at _____ Date _____ County Document No. _____

Identified on aerial photo No. _____ Which is filed at _____

Index No. F-17
(Alphabetical - Numerical)T. 148 N R. 26 W
SECTIONBook #1
Page #34
5+NLAND CORNER RECORD
(RECTANGULAR SURVEYS)Mer. N.F. CLIPPOWA County ITASCA State MN
Corner common to sections 3, 2, 10 and 11R9-7150-4 (Rev. 6/13/67)
SPD 502-127

EXISTING SURVEYS

Original Government Survey
Year surveyed _____
Original monument _____ <small>(Wood post, stone, pile of stones, pipe, etc.)</small>
Bearing Trees
Species _____
Diameter _____
Bearing _____
Distance _____

Original Evidence Found
Year of search _____ By _____
Monument found _____
Original Bearing Trees Found
Species _____
Diameter _____
Bearing _____
Distance _____

Subsequent Corner Restoration
Year surveyed <u>1963</u> By <u>Okerman - U.S.F.S.</u>
Where filed or recorded _____
Monument _____ <small>(Original, concrete post, iron rod, etc.)</small>

Evidence of Subsequent Corner Restoration Found
Year of search <u>6-20-79</u> By <u>JIM SCHMIDT</u>
<u>Monument and BT's - Good condition.</u>

Bearing Trees, Reference Objects
Species _____
Diameter _____
Bearing _____
Distance _____

Bearing Trees, Reference Objects			
<u>MAPLE</u>	<u>Maple</u>	<u>Maple</u>	<u>Birch</u>
<u>7"</u>	<u>7"</u>	<u>7"</u>	<u>10"</u>
<u>S 75° E</u>	<u>N 9° E</u>	<u>S 64° W</u>	<u>N 52° W</u>
<u>33.1'</u>	<u>142.2'</u>	<u>43.0'</u>	<u>34.5'</u>

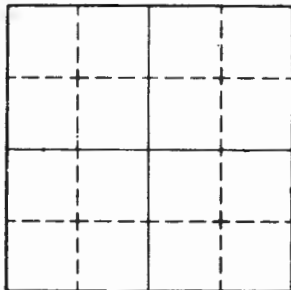

Sketch

○ Corner ▨ F.S. Land

Relation of Evidence to Record Features Along Section Lines

Section line to sections _____

Object _____

Record distance _____

Measured distance _____

Other Evidence

Describe evidence of use and occupation such as roads, fences, clearings, timber cutting lines, plantations, etc.. Cite source of testimony if any. _____

At time of search:

1. Did you have the record description?

Yes _____ No _____

2. How was search area located?

Pacing, chaining, photos, maps, etc. _____

3. Man hours spent in search _____

4. Do you think additional search might recover evidence? Yes _____ No _____

5. Signature _____

Perpetuation Record

Monument and accessories established. Include brief description of area. _____

Certified corner restoration certificate prepared: Yes _____ No _____

Filed in county records at _____ Date _____ County Document No. _____

Identified on aerial photo No. _____ Which is filed at _____

T. 148 N. R. 26 W. 5th Mer. N.F. Chippewa County _____ State _____
 Corner common to sections 2 1 11 and 12

EXISTING SURVEYS

Original Government Survey

Year surveyed _____

Original monument _____
(Wood post, stone, pile of stones, pipe, etc.)

Bearing Trees

Species _____

Diameter _____

Bearing _____

Distance _____

Subsequent Corner Restoration

Year surveyed _____ By _____

Where filed or recorded _____

Monument _____
(Original, concrete post, iron rod, etc.)

Bearing Trees, Reference Objects

Species _____

Diameter _____

Bearing _____

Distance _____

Original Evidence Found

Year of search _____ By _____

Monument found _____

Original Bearing Trees Found

Species _____

Diameter _____

Bearing _____

Distance _____

Evidence of Subsequent Corner Restoration Found

Year of search April, 1982 By USFSRecovered 1962 monument. Established
a metal fence post, north, 3.7 ft with
54/2 + 54-9

Bearing Trees, Reference Objects

<u>1962 Elm</u>	<u>1962 maple</u>	<u>1921 Boxwood</u>	<u>1921 maple</u>
<u>9.5"</u>	<u>13.8"</u>	<u>13.7"</u>	<u>12.5"</u>
<u>N 46° E</u>	<u>S 42° E</u>	<u>S 88° W</u>	<u>N 12° W</u>
<u>35.99'</u>	<u>28.83'</u>	<u>18.70'</u>	<u>22.91'</u>
<u>to 16d mile SE</u>	<u>to 16d mile SE</u>	<u>to 16d mile SE</u>	<u>to 16d mile SE</u>

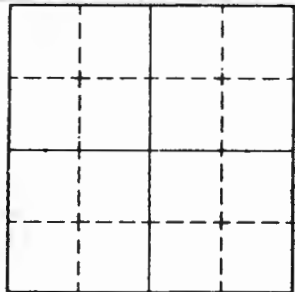

Sketch

O Corner ▨ F.S. Land

Section line to sections _____
 Object _____
 Record distance _____
 Measured distance _____

Other Evidence

Describe evidence of use and occupation such as roads, fences, clearings, timber cutting lines, plantations, etc.. Cite source of testimony if any. _____

At time of search:

1. Did you have the record description?
 Yes _____ No _____

2. How was search area located?
 Pacing, chaining, photos, maps, etc. _____

3. Man hours spent in search _____

4. Do you think additional search might recover evidence? Yes _____ No _____

5. Signature _____

Perpetuation Record

Monument and accessories established. Include brief description of area. _____

Certified corner restoration certificate prepared: Yes _____ No _____

Filed in county records at _____ Date _____ County Document No. _____

Identified on aerial photo No. _____ Which is filed at _____

148 R 26
Sec 1

Mer. N.F. CHIPPewa County

State MW
Corner common to sections 2, 1, 11 and 12

EXISTING SURVEYS

Original Government Survey

Year surveyed _____
Original monument _____
(Wood post, stone, pile of stones, pipe, etc.)

Bearing Trees

Species _____
Diameter _____
Bearing _____
Distance _____

Original Evidence Found

Year of search _____ By _____
Monument found _____

Original Bearing Trees Found

Species _____
Diameter _____
Bearing _____
Distance _____

Subsequent Corner Restoration

Year surveyed 1962 By U.S.F.S.

Where filed or recorded _____
Monument 2" x 5" Iron pipe w/ Brass cap.
(Original, concrete, steel, wood, etc.)

County Butte
Maple
20' N12W
23.3'
12.1'
Cedar
587W
18.0'

Bearing Trees, Reference Objects

Species	Maple	Maple	Elm	stake post
Diameter	12"	10"	9"	6"
Bearing	S44E	N13W	N48E	S61W
Distance	29.1'	23.3'	36.65'	7.5'

Evidence of Subsequent Corner Restoration Found

Year of search 1979 By Jim Sehouver

Monument + BTs in good condition

Bearing Trees, Reference Objects

ELM	Maple	Maple
N10"	12"	14"
N49°E	N13°W	S44°E
36.65'	23.3'	29.1'

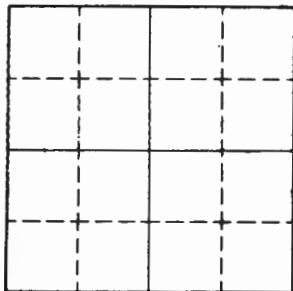

Sketch

Corner F.S. Land

At time of search:

1. Did you have the record description?

Yes _____ No _____

2. How was search area located?

Pacing, chaining, photos, maps,
etc. _____

3. Man hours spent in search _____

4. Do you think additional search might
recover evidence? Yes _____ No _____

5. Signature _____

Relation of Evidence to Record Features Along Section Lines

Section line to sections _____
Object _____
Record distance _____
Measured distance _____

Other Evidence

Describe evidence of use and occupation such as roads, fences, clearings, timber cutting lines, plantations, etc.. Cite source of testimony if any. _____

Perpetuation Record

Monument and accessories established. Include brief description of area. _____

SET STEEL POST WITH ATTENTION
+ BOUNDARY SIGNS 6.6' EAST OF MONUMENT

Certified corner restoration certificate prepared: Yes _____ No _____

Filed in county records at _____ Date _____ County Document No. _____

Identified on aerial photo No. _____ Which is filed at _____

Index No. E-22
(Alphabetical - Numerical)

Book #1
Page #9

LAND CORNER RECORD
(RECTANGULAR SURVEYS)

RP-7150-4 (Rev. 6/13/67)
 GPO 802-127

T. 148 N R. 26 W
West 1/4

Mer. N.F. Chippewa County Itasca
 Corner common to sections 1 8 12

State Minnesota
 and _____

EXISTING SURVEYS

Original Government Survey

Year surveyed _____
 Original monument _____
(Wood post, stone, pile of stones, pipe, etc.)

Bearing Trees

Species _____
 Diameter _____
 Bearing _____
 Distance _____

Subsequent Corner Restoration

Year surveyed 1962 By U.S.F.S
 Where filed or recorded _____
 Monument 24.25' P.D. w/ Brass cap
(Original, concrete post, iron rod, etc.)

Bearing Trees, Reference Objects

Species	<u>Koak</u>	<u>Rock</u>	<u>Birch</u>
Diameter	<u>2' x 2 1/2'</u>	<u>2' x 2 1/2' x 20'</u>	<u>8"</u>
Bearing	<u>N 35 E</u>	<u>S 45 E</u>	<u>S 26 W</u>
Distance	<u>14.5'</u>	<u>77.15'</u>	<u>2.5'</u>

Original Evidence Found

Year of search _____ By _____
 Monument found _____

Original Bearing Trees Found

Species _____
 Diameter _____
 Bearing _____
 Distance _____

Evidence of Subsequent Corner Restoration Found

Year of search 1980 By R. Olesen
Monument in good condition

Bearing Trees, Reference Objects

Species	<u>Rock</u>	<u>Rock</u>	<u>Birch</u>	<u>Steel post</u>
Diameter	<u>Disc</u>	<u>Disc</u>	<u>12"</u>	<u>1/2"</u>
Bearing	<u>Out</u>	<u>Out</u>	<u>S 26 W</u>	<u>West</u>
Distance			<u>7.3'</u>	<u>7.7'</u>

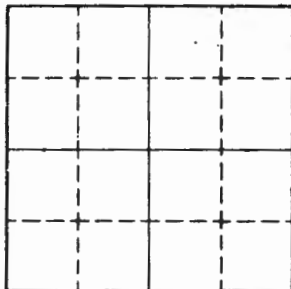

Sketch

○ Corner F.S. Land

Relation of Evidence to Record Features Along Section Lines

Section line to sections _____
 Object _____
 Record distance _____
 Measured distance _____

Other Evidence

Describe evidence of use and occupation such as roads, fences, clearings, timber cutting lines, plantations, etc.. Cite source of testimony if any. _____

At time of search:

1. Did you have the record description?
 Yes _____ No _____

2. How was search area located?
 Pacing, chaining, photos, maps,
 etc. _____

3. Man hours spent in search _____

4. Do you think additional search might
 recover evidence? Yes _____ No _____

5. Signature _____

Perpetuation Record

Monument and accessories established. Include brief description of area. _____

Iron + N. B.T.S.

<i>Birk</i>	<i>Birch</i>
<i>6"</i>	<i>8"</i>
<i>SSE</i>	<i>N20W</i>
<i>21.2'</i>	<i>43.92'</i>
<i>W 1/2 S12</i>	<i>W 1/2 S1</i>
<i>BT</i>	<i>B</i>

5/2

Certified corner restoration certificate prepared: Yes _____ No _____

Filed in county records at _____ Date _____ County Document No. _____

Identified on aerial photo No. _____ Which is filed at _____

Index No. F-23
(Alphabetical - Numerical)

LAND CORNER RECORD
(RECTANGULAR SURVEYS)

RD-7 150-4 (Rev. 6/13/67)
GPO 802-127

T. 148 N. R. 26 W. 5th Mer. N.F. Chippewa County _____ State _____
1/4 Corner common to sections _____, _____, _____ and 12

EXISTING SURVEYS

Original Government Survey	Original Evidence Found
Year surveyed _____	Year of search _____ By _____
Original monument _____ <small>(Wood post, stone, pile of stones, pipe, etc.)</small>	Monument found _____
Bearing Trees	Original Bearing Trees Found
Species _____	Species _____
Diameter _____	Diameter _____
Bearing _____	Bearing _____
Distance _____	Distance _____
Subsequent Corner Restoration	Evidence of Subsequent Corner Restoration Found
Year surveyed _____ By _____	Year of search _____ By _____
Where filed or recorded _____	_____
Monument _____ <small>(Original, concrete post, iron rod, etc.)</small>	_____
_____	_____
_____	_____
Bearing Trees, Reference Objects	Bearing Trees, Reference Objects
Species _____	_____
Diameter _____	_____
Bearing _____	_____
Distance _____	_____

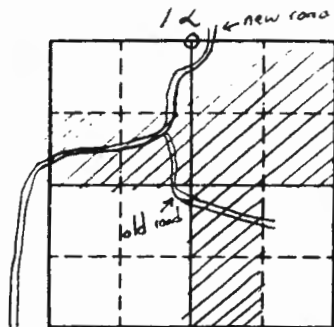

Sketch

○ Corner ▨ F.S. Land

Relation of Evidence to Record Features Along Section Lines

Section line to sections	_____	_____	_____	_____
Object	_____	_____	_____	_____
Record distance	_____	_____	_____	_____
Measured distance	_____	_____	_____	_____

Other Evidence

Describe evidence of use and occupation such as roads, fences, clearings, timber cutting lines, plantations, etc.. Cite source of testimony if any. *Corner is about 150 ft west of new road and about 250 ft North of same road. Red line runs N & S from corner*

At time of search:

1. Did you have the record description?

Yes _____ No _____

2. How was search area located?

Pacing, chaining, photos, maps, etc. _____

3. Man hours spent in search _____

4. Do you think additional search might recover evidence? Yes _____ No _____

Perpetuation Record

Monument and accessories established. Include brief description of area. *April 1962*
USFS recovered 1962 monument w/ 1" steel fence post, up 1.9 ft
From which bears:
 1979 Ash, 4.4", N42°E, 18.56' to 16d nail in NW face
 1962 Ash, 9.1", S44°W, 31.58' to 16d nail in SE face
 1962 Ash, 8.6", N31°W, 26.26' to 16d nail in SW face
 County Ash, 10.0", N27°W, 18.48' to 16d nail in SW face
 Metal fence post, north, 2.84", w/ 54-2, 54-4
 Metal fence post, south, 6.10", w/ 54-2, 54-4

Certified corner restoration certificate prepared: Yes _____ No _____

Filed in county records at _____ Date _____ County Document No. _____

T. 140 N. R. 26 W. S. 5th Mer. N.F. Chippewa County Itasca State Minnesota
1/4 Corner common to sections 1, 8, 12 end

EXISTING SURVEYS

Original Government Survey

Year surveyed _____
Original monument _____
(Wood post, stone, pile of stones, pipe, etc.)

Bearing Trees

Species _____
Diameter _____
Bearing _____
Distance _____

Subsequent Corner Restoration

Year surveyed: 1962 By U.S. F.S.
Where filed or recorded _____
Monument 2" x 5" Iron pipe with Brass Cap.
(Original, concrete post, iron rod, etc.)

Bearing Trees, Reference Objects

Species	<u>Ash</u>	<u>Ash</u>	<u>Stool post</u>
Diameter	<u>5"</u>	<u>6"</u>	<u>6"</u>
Bearing	<u>S 47° W</u>	<u>N 30° W</u>	<u>South</u>
Distance	<u>31.5'</u>	<u>26.3'</u>	<u>5.4'</u>

Original Evidence Found

Year of search _____ By _____
Monument found _____

Original Bearing Trees Found

Species _____
Diameter _____
Bearing _____
Distance _____

Evidence of Subsequent Corner Restoration Found

Year of search 1989 By R. Olson
Monument in place

Bearing Trees, Reference Objects

Species	<u>Ash</u>	<u>Ash</u>
Diameter	<u>8"</u>	<u>8"</u>
Bearing	<u>N 30° W</u>	<u>S 47° W</u>
Distance	<u>26.3'</u>	<u>31.5'</u>

E-23

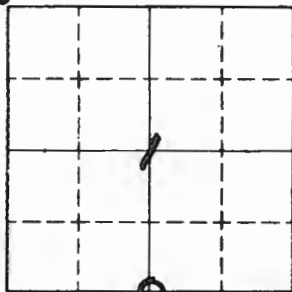

Sketch

○ Corner ▨ F.S. Land

Relation of Evidence to Record Features Along Section Lines

Section line to sections _____
 Object _____
 Record distance _____
 Measured distance _____

Other Evidence

Describe evidence of use and occupation such as roads, fences, clearings, timber cutting lines, plantations, etc.. Cite source of testimony if any. _____

At time of search:

1. Did you have the record description?

Yes _____ No _____

2. How was search area located?

Pacing, chaining, photos, maps, etc. _____

3. Man hours spent in search _____

4. Do you think additional search might recover evidence? Yes _____ No _____

5. Signature _____

Perpetuation Record

Monument and accessories established. Include brief description of area.

To bring this corner to standard I cut New
 B.T.

Ash stud Post

4" 8"

N43E North

18.5' 2.6'

R 07 54-2 54-4

11/79
 Ronald Olson

Certified corner restoration certificate prepared: Yes _____ No _____

Filed in county records at _____ Date _____ County Document No. _____

Identified an aerial photo No. _____ Which is filed at _____

Index No. E-25' E-25
(Alphabetical - Numerical)

LAND CORNER RECORD
(RECTANGULAR SURVEYS)

RD-7 150-4 (Rev. 6/13/67)
GPO 802-127

T. 148 R. 25 5TH Mer. N.F. CHIPPewa County ITASCA State MINN.
SEC. Corner common to sections 1 , 6 , 7 and 12

EXISTING SURVEYS

Original Government Survey

Year surveyed _____

Original monument _____
(Wood post, stone, pile of stones, pipe, etc.)

Bearing Trees

Species _____

Diameter SEE BOOK 2 Pg 19 (148-25)

Bearing ALSO Book 3 Pg 6 (148-26)

Distance _____

Subsequent Corner Restoration

Year surveyed _____ By _____

Where filed or recorded _____

Monument _____
(Original, concrete post, iron rod, etc.)

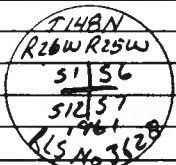

Bearing Trees, Reference Objects

Species _____

Diameter _____

Bearing _____

Distance _____

Original Evidence Found

Year of search _____ By _____

Monument found _____

Original Bearing Trees Found

Species _____

Diameter _____

Bearing _____

Distance _____

Evidence of Subsequent Corner Restoration Found

Year of search _____ By _____

Bearing Trees, Reference Objects

Species _____

Diameter _____

Bearing _____

Distance _____

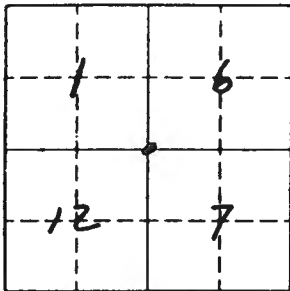

Sketch

Corner F.S. Land

Relation of Evidence to Record Features Along Section Lines

Section line to sections _____
 Object _____
 Record distance _____
 Measured distance _____

Other Evidence

Describe evidence of use and occupation such as roads, fences, clearings, timber cutting lines, plantations, etc.. Cite source of testimony if any. 7-21-83 B. AUSK
BRASS CAP OK SW & NW TREES OK G. ROBERTSON
NO EVIDENCE OF NE & SE TREES D. HARMAN

Red line runs south from corner

At time of search:

1. Did you have the record description?

Yes _____ No _____

2. How was search area located?

Pacing, chaining, photos, maps, etc. _____

3. Man hours spent in search _____

4. Do you think additional search might recover evidence? Yes _____ No _____

5. Signature _____

Perpetuation Record

Monument and accessories established. Include brief description of area. March, 1984
USFS recovered monument, up 1.8 ft

1961 Maple, 12.1", S78°W, 10.98' to nail in N. face

1961 Maple, 7.3", N46°W, 26.60' to nail in NE face

New Maple, 6.5", N58°E, 30.26' to nail in SE face

New Maple, 9.0", S84°E, 77.55' to nail in N. face

Note: face post, south, 3.0', with signs

All BT's & post painted red

5° declination

Certified corner restoration certificate prepared: Yes _____ No _____

Filed in county records at _____ Date _____ County Document No. _____

Identified on aerial photo No. _____ Which is filed at _____

T. 148 N. 26 Mer. N.F. CHIPPENAW County Itasca State Mn
N 716 Corner common to sections 9 and 10

EXISTING SURVEYS

Original Government Survey

Year surveyed _____
Original monument _____
(Wood post, stone, pile of stones, pipe, etc.)

Bearing Trees

Species _____
Diameter _____
Bearing _____
Distance _____

Subsequent Corner Restoration

Year surveyed 1962 By U.S. F.S.
Where filed or recorded _____
Monument 2" x 2" Iron w/ brass cap
(Original, concrete post, iron rod, etc.)

Bearing Trees, Reference Objects

Species	<u>Tam</u>	<u>Tam</u>	<u>Tam</u>	<u>steel post</u>
Diameter	<u>4"</u>	<u>7"</u>	<u>6"</u>	<u>6"</u>
Bearing	<u>S76°E</u>	<u>N25°E</u>	<u>N61°W</u>	<u>South</u>
Distance	<u>48.0'</u>	<u>15.8'</u>	<u>7.25'</u>	<u>4.85'</u>

Original Evidence Found

Year of search _____ By _____
Monument found _____

Original Bearing Trees Found

Species _____
Diameter _____
Bearing _____
Distance _____

Evidence of Subsequent Corner Restoration Found

Year of search 12-4-79 By Jim Schoonover
Monument AND BT's IN
GOOD CONDITION

Bearing Trees, Reference Objects

Species	<u>TAM.</u>	<u>TAM</u>	<u>TAM</u>	<u>steel post</u>
Diameter	<u>6"</u>	<u>6"</u>	<u>8"</u>	<u>6"</u>
Bearing	<u>S76 1/2°E</u>	<u>N61°W</u>	<u>N25°W</u>	<u>South</u>
Distance	<u>48.0'</u>	<u>7.25'</u>	<u>15.8'</u>	<u>4.85'</u>

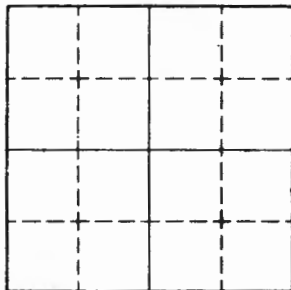

Sketch

Corner F.S. Land

Relation of Evidence to Record Features Along Section Lines

Section line to sections _____
Object _____
Record distance _____
Measured distance _____

Other Evidence

Describe evidence of use and occupation such as roads, fences, clearings, timber cutting lines, plantations, etc.. Cite source of testimony if any. _____

At time of search:

1. Did you have the record description?

Yes _____ No _____

2. How was search area located?

Pacing, chaining, photos, maps, etc. _____

3. Man hours spent in search _____

4. Do you think additional search might recover evidence? Yes _____ No _____

5. Signature _____

Perpetuation Record

Monument and accessories established. Include brief description of area. _____

*Set steel post 8' North 49.3'
w/ signs 54-2 & 54-4*

Certified corner restoration certificate prepared: Yes _____ No _____

Filed in county records at _____ Date _____ County Document No. _____

Identified on aerial photo No. _____ Which is filed at _____

Index No. F-15
(Alphabetical - Numerical)

Book - 1
Page 39

LAND CORNER RECORD
(RECTANGULAR SURVEYS)

R9-7150-4 (Rev. 6/13/67)
 GPO 502-127

T. 148 N, 26 W Mer. N.F. C. HIPPONIA County ITASCA State MINN
C N 1/4 Corner common to sections 10 and _____

EXISTING SURVEYS

Original Government Survey	Original Evidence Found
Year surveyed _____	Year of search _____ By _____
Original monument _____ <small>(Wood post, stone, pile of stones, pipe, etc.)</small>	Monument found _____
Bearing Trees	Original Bearing Trees Found
Species _____	Species _____
Diameter _____	Diameter _____
Bearing _____	Bearing _____
Distance _____	Distance _____
Subsequent Corner Restoration	Evidence of Subsequent Corner Restoration Found
Year surveyed <u>1963</u> By <u>Okerman - U.S.F.S.</u>	Year of search <u>7-13-79</u> By <u>Jim Schoonover</u>
Where filed or recorded _____	_____
Monument _____ <small>(Original, concrete post, iron rod, etc.)</small>	<u>Monument in good condition</u>
Bearing Trees, Reference Objects	Bearing Trees, Reference Objects
Species _____	<u>ASN</u> <u>Rock</u> <u>Rock</u>
Diameter _____	<u>8"</u> <u>3' x 2.5'</u> <u>3' x 2.5'</u>
Bearing _____	<u>S 88° E</u> <u>N 14° W</u> <u>S 48° W</u>
Distance _____	<u>79.1'</u> <u>75.5'</u> <u>8.8'</u>
	<u>X</u> <u>X</u>

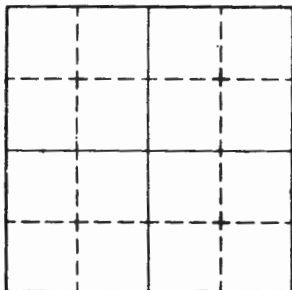

Sketch

○ Corner ▨ F.S. Land

Relation of Evidence to Record Features Along Section Lines

Section line to sections _____

Object _____

Record distance _____

Measured distance _____

Other Evidence

Describe evidence of use and occupation such as roads, fences, clearings, timber cutting lines, plantations, etc.. Cite source of testimony if any. _____

At time of search:

1. Did you have the record description?

Yes _____ No _____

2. How was search area located?

Pacing, chaining, photos, maps, etc. _____

3. Man hours spent in search _____

4. Do you think additional search might recover evidence? Yes _____ No _____

5. Signature _____

Perpetuation Record

Monument and accessories established. Include brief description of area. _____

Certified corner restoration certificate prepared: Yes _____ No _____

Filed in county records at _____ Date _____ County Document No. _____

Identified on aerial photo No. _____ Which is filed at _____

Index No. F-15
(Alphabetical - Numerical)

copy to Dec 1 R-^e
 Book #1
 Page 9

LAND CORNER RECORD
(RECTANGULAR SURVEYS)

RP-7150-4 (Rev. 6/13/67)
 GPO 802-127

T. 148 N. R. 26 W. 5th Mer. N.F. Chippewa County Itasca State Minnesota
Center North 1/4 Corner common to sections 10 and _____

EXISTING SURVEYS

Original Government Survey

Year surveyed _____
 Original monument _____
(Wood post, stone, pile of stones, pipe, etc.)

Bearing Trees

Species _____
 Diameter _____
 Bearing _____
 Distance _____

Subsequent Corner Restoration

Year surveyed 1963 By U C F S
 Where filed or recorded _____
 Monument 6" Concrete Monument with
Brass cap
(Original, concrete post, iron rod, etc.)

Bearing Trees, Reference Objects

Species	<u>Rock</u>	<u>Rock</u>	<u>Asb</u>
Diameter	<u>3x2 1/2</u>	<u>3x2 1/2</u>	<u>7"</u>
Bearing	<u>S48W</u>	<u>N14W</u>	<u>S8E</u>
Distance	<u>8.8'</u>	<u>75.5'</u>	<u>79.1'</u>

Original Evidence Found

Year of search _____ By _____
 Monument found _____

Original Bearing Trees Found

Species _____
 Diameter _____
 Bearing _____
 Distance _____

Evidence of Subsequent Corner Restoration Found

Year of search 1981 By R. Olesen
Monument in place and in good
condition

Bearing Trees, Reference Objects

All bearings in good condition
3/11/81
Ronald Olesen

Relation of Evidence to Record Features Along Section Lines

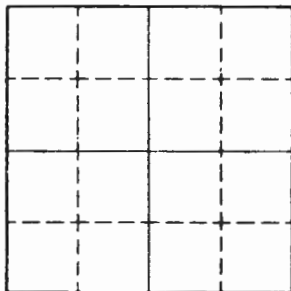

Sketch

○ Corner ▨ F.S. Land

Section line to sections _____

Object _____

Record distance _____

Measured distance _____

Other Evidence

Describe evidence of use and occupation such as roads, fences, clearings, timber cutting lines, plantations, etc.. Cite source of testimony if any. _____

At time of search:

1. Did you have the record description?

Yes _____ No _____

2. How was search area located?

Pacing, chaining, photos, maps, etc. _____

3. Man hours spent in search _____

4. Do you think additional search might

recover evidence? Yes _____ No _____

5. Signature _____

Perpetuation Record

Monument and accessories established. Include brief description of area. _____

Certified corner restoration certificate prepared: Yes _____ No _____

Filed in county records at _____ Date _____ County Document No. _____

Identified on aerial photo No. _____ Which is filed at _____

T. 148 R. 26 5th Mer. N.F. Chippewa County Itasca State Minn.
N 11/16 Corner common to sections 11 and 12

EXISTING SURVEYS

Original Government Survey

Year surveyed _____
Original monument _____
(Wood post, stone, pile of stones, pipe, etc.)

Bearing Trees

Species _____
Diameter _____
Bearing _____
Distance _____

Original Evidence Found

Year of search _____ By _____
Monument found _____

Original Bearing Trees Found

Species _____
Diameter _____
Bearing _____
Distance _____

Subsequent Corner Restoration

Year surveyed April, 1984 By USFS
Where filed or recorded Itasca County Court House
Monument Set to 5 ft. long in 2 1/2 in O.D.
(Original, concrete post, iron rod, etc.)
Circular filled galvanized iron pipe cap
1 1/2" 3 in dia brass cap stamped:
5° decl

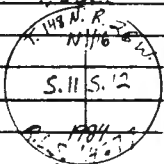

Bearing Trees, Reference Objects

Species	<u>W. Spruce</u>	<u>S. Maple</u>	<u>S. Maple</u>	<u>2 fence posts</u>
Diameter	<u>11.6"</u>	<u>6.1"</u>	<u>9.8"</u>	<u>1 east</u>
Bearing	<u>N 65° E</u>	<u>S 19° E</u>	<u>N 70° W</u>	<u>1 west</u>
Distance	<u>27.85'</u>	<u>46.55'</u>	<u>51.74'</u>	<u>3.0'</u>

Evidence of Subsequent Corner Restoration Found

Year of search _____ By _____

Bearing Trees, Reference Objects

Species	_____	_____	_____	_____
Diameter	_____	_____	_____	_____
Bearing	_____	_____	_____	_____
Distance	_____	_____	_____	_____

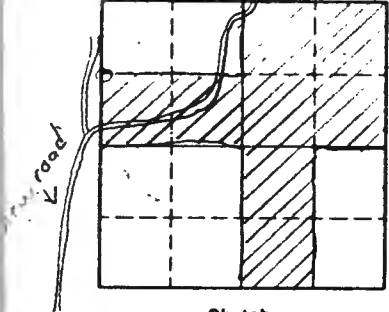

Sketch

O Corner ▨ F.S. Land

Section line to sections _____

Object _____

Record distance _____

Measured distance _____

Other Evidence

Describe evidence of use and occupation such as roads, fences, clearings, timber cutting lines, plantations, etc.. Cite source of testimony if any. Red line runs east from monument. See Bk 3 Pg 76

At time of search:

1. Did you have the record description?

Yes _____ No _____

2. How was search area located?

Pacing, chaining, photos, maps, etc. _____

3. Man hours spent in search _____

4. Do you think additional search might recover evidence? Yes _____ No _____

Signature _____

Perpetuation Record

Monument and accessories established. Include brief description of area. _____

Certified corner restoration certificate prepared: Yes _____ No _____

Filed in county records at _____ Date _____ County Document No. _____

Identified on aerial photo No. _____ Which is filed at _____

Index No. F-23
(Alphabetical - Numerical)LAND CORNER RECORD
(RECTANGULAR SURVEYS)R9-7150-4 (Rev. 6/13/67)
GPO 502-127T. 149 R. 26 5th Mer. N.F. Chippewa County Itasca State Ma
CN 1/16 Corner common to sections 12 and _____

EXISTING SURVEYS

Original Government Survey

Year surveyed _____
Original monument _____
(Wood post, stone, pile of stones, pipe, etc.)

Bearing Trees

Species _____
Diameter _____
Bearing _____
Distance _____

Subsequent Corner Restoration

Year surveyed Apr. 1, 1984 By USFS
Where filed or recorded Itasca County Courthouse
Monument Set a 10 ft. long by 3/4 in. O.D.
(Original, concrete post, iron rod, etc.)
aluminum rod monument up 18 inches
with a 3/4 in aluminum cap stamped:
5° decl

Bearing Trees, Reference Objects

Species B. Spruce Cedar Cedar 2 fence posts
Diameter 15.3" 15.7" 11.8" 1 north
Bearing N157°E S29°E S33°W 1 west
Distance 86.16' 59.47' 24.84' 3.0'

Original Evidence Found

Year of search _____ By _____
Monument found _____

Original Bearing Trees Found

Species _____
Diameter _____
Bearing _____
Distance _____

Evidence of Subsequent Corner Restoration Found

Year of search _____ By _____

Bearing Trees, Reference Objects

_____

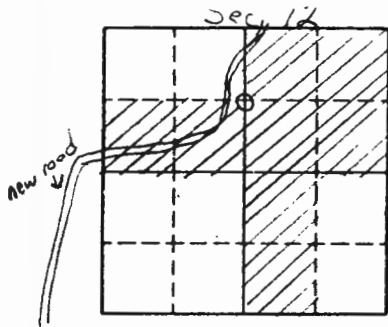

Sketch

○ Corner ▨ F.S. Land

Relation of Evidence to Record Features Along Section Lines

Section line to sections	_____	_____	_____	_____
Object	_____	_____	_____	_____
Record distance	_____	_____	_____	_____
Measured distance	_____	_____	_____	_____

Other Evidence

Describe evidence of use and occupation such as roads, fences, clearings, timber cutting lines, plantations, etc.. Cite source of testimony if any. *Red line runs N+W from monument. See BK 3 Pg 75*

At time of search:

1. Did you have the record description?

Yes _____ No _____

2. How was search area located?

Pacing, chaining, photos, maps, etc. _____

3. Man hours spent in search _____

4. Do you think additional search might recover evidence? Yes _____ No _____

5. Signature _____

Perpetuation Record

Monument and accessories established. Include brief description of area. _____

Certified corner restoration certificate prepared: Yes _____ No _____

Filed in county records of _____ Date _____ County Document No. _____

Identified on aerial photo No. _____ Which is filed at _____

T. 148 N. R. 26 W 5 Mer. N.F. Chippewa County Itasca State MN
N7E Corner common to sections 7 12 and 148-25 148-26

EXISTING SURVEYS

Original Government Survey

Year surveyed _____ By _____

Original monument _____
(Wood post, stone, pile of stones, pipe, etc.)

Bearing Trees

Species _____

Diameter _____

Bearing _____

Distance _____

Original Evidence Found

Year of search _____ By _____

Monument found _____

Original Bearing Trees Found

Species _____

Diameter _____

Bearing _____

Distance _____

Subsequent Corner Restoration

Year surveyed _____ By _____

Where filed or recorded _____

Monument _____
(Original, concrete post, iron rod, etc.)

Evidence of Subsequent Corner Restoration Found

Year of search _____ By _____

See Cert. 7148 NR 25 W

Bearing Trees, Reference Objects

Species _____

Diameter _____

Bearing _____

Distance _____

Bearing Trees, Reference Objects

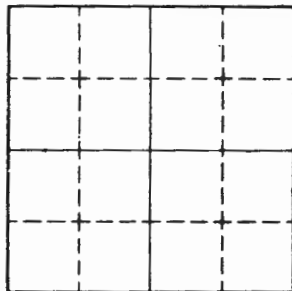

Sketch

Corner F.S. Land

Relation of Evidence to Record Features Along Section Lines

Section line to sections _____
Object _____
Record distance _____
Measured distance _____

Other Evidence

Describe evidence of use and occupation such as roads, fences, clearings, timber cutting lines, plantations, etc.. Cite source of testimony if any. _____

At time of search:

1. Did you have the record description?

Yes _____ No _____

2. How was search area located?

Pacing, chaining, photos, maps, etc. _____

3. Man hours spent in search _____

4. Do you think additional search might

recover evidence? Yes _____ No _____

5. Signature _____

Perpetuation Record

Monument and accessories established. Include brief description of area. _____

Certified corner restoration certificate prepared: Yes _____ No _____

Filed in county records at _____ Date _____ County Document No. _____

Identified on aerial photo No. _____ Which is filed at _____

T. 148 N. R. 26 W.
1/4

Mer. N.F. Chippewa County Itasca
Corner common to sections 9 & 10

State Minnesota

EXISTING SURVEYS

Original Government Survey

Year surveyed _____
Original monument _____
(Wood post, stone, pile of stones, pipe, etc.)

Bearing Trees

Species _____
Diameter _____
Bearing _____
Distance _____

Subsequent Corner Restoration

Year surveyed 1962 By U.S.F.S.
Where filed or recorded _____
Monument 2"x5" Iron w/ brass cap.
(Original, concrete post, iron rod, etc.)

Bearing Trees, Reference Objects

Species	<u>Twin Cedar</u>	<u>Cedar</u>	<u>Steel Post</u>
Diameter	<u>10"</u>	<u>4"</u>	<u>6"</u>
Bearing	<u>N53E</u>	<u>S43 1/2 W</u>	<u>North</u>
Distance	<u>24.9'</u>	<u>25.45'</u>	<u>5.05'</u>

Original Evidence Found

Year of search _____ By _____
Monument found _____

Original Bearing Trees Found

Species _____
Diameter _____
Bearing _____
Distance _____

Evidence of Subsequent Corner Restoration Found

Year of search 1980 By R. Oles
Monument in place.

Bearing Trees, Reference Objects

Species	<u>Twin Cedar</u>	<u>Cedar</u>	<u>Steel Post</u>
Diameter	<u>11"</u>	<u>7"</u>	<u>6"</u>
Bearing	<u>N52 1/2 E</u>	<u>S43 1/2 W</u>	<u>North</u>
Distance	<u>34.9'</u>	<u>25.45'</u>	<u>5.05'</u>

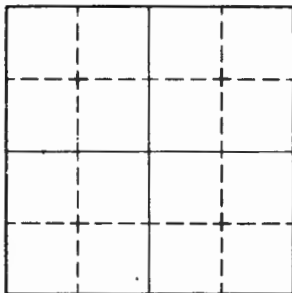

Sketch

○ Corner ▨ F.S. Land

Relation of Evidence to Record Features Along Section Lines

Section line to sections _____
 Object _____
 Record distance _____
 Measured distance _____

Other Evidence

Describe evidence of use and occupation such as roads, fences, clearings, timber cutting lines, plantations, etc.. Cite source of testimony if any. _____

At time of search:

1. Did you have the record description?
 Yes _____ No _____

2. How was search area located?
 Pacing, chaining, photos, maps,
 etc. _____

3. Man hours spent in search _____

4. Do you think additional search might
 recover evidence? Yes _____ No _____

5. Signature _____

6/3/80
 Remond

Perpetuation Record

Monument and accessories established. Include brief description of area.
 To bring corner to standard E cut
 New BT.
 Cedar steel post
 12" 8"
 S35E south
 10.12' 4.2'
 44510 34-2 54-7
 BT

Certified corner restoration certificate prepared: Yes _____ No _____

Filed in county records at _____ Date _____ County Document No. _____

Identified on aerial photo No. _____ Which is filed at _____

Index No. G-15
(Alphabetical - Numerical)

1730 LAND CORNER RECORD
(RECTANGULAR SURVEYS)

R9-7150-4 (Rev. 6/13/87) S.O.
GPO 802-127

T. 148N R. 26W Mer. N.F. Chippewa County Itasca State Minnesota
Center 1/4 Corner common to sections 10 and _____

EXISTING SURVEYS

Original Government Survey

Year surveyed _____
Original monument _____
(Wood post, stone, pile of stones, pipe, etc.)

Bearing Trees

Species _____
Diameter _____
Bearing _____
Distance _____

Subsequent Corner Restoration

Year surveyed. 1963 By U.S.F.
Where filed or recorded _____
Monument 2" x 5" Iron pipe with Brass cap
(Original, concrete post, iron rod, etc.)

Bearing Trees, Reference Objects

Species	<u>Aspen</u>	<u>Birch</u>	<u>Steel post</u>	<u>Steel post</u>
Diameter	<u>8"</u>	<u>6"</u>	<u>10"</u>	<u>6"</u>
Bearing	<u>N61W</u>	<u>N81E</u>	<u>North</u>	<u>South</u>
Distance	<u>10.0'</u>	<u>65.2'</u>	<u>4.2'</u>	<u>3.5'</u>

Original Evidence Found

Year of search _____ By _____
Monument found _____

Original Bearing Trees Found

Species _____
Diameter _____
Bearing _____
Distance _____

Evidence of Subsequent Corner Restoration Found

Year of search 1981 By J
Monument in place and in good condition

Bearing Trees, Reference Objects

Species	<u>Aspen</u>	<u>Birch</u>	<u>Steel post</u>
Diameter	<u>12"</u>	<u>6"</u>	<u>6"</u>
Bearing	<u>N61W</u>	<u>N81E</u>	<u>South</u>
Distance	<u>10.0'</u>	<u>65.2'</u>	<u>3.5'</u>

Relation of Evidence to Record Features Along Section Lines

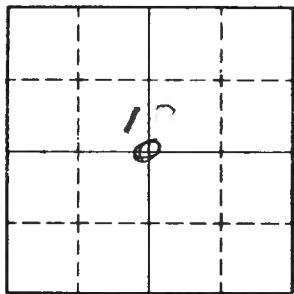

Sketch

O Corner ▨ F.S. Land

Section line to sections _____

Object _____

Record distance _____

Measured distance _____

Other Evidence

Describe evidence of use and occupation such as roads, fences, clearings, timber cutting lines, plantations, etc.. Cite source of testimony if any. _____

At time of search:

1. Did you have the record description?
Yes _____ No _____

2. How was search area located?
Pacing, chaining, photos, maps, etc. _____

3. Man hours spent in search _____

4. Do you think additional search might recover evidence? Yes _____ No _____

5. Signature _____

Perpetuation Record

Monument and accessories established. Include brief description of area.
To bring this corner to Standard E Cut New BT

<u>Birch</u>	<u>Birch</u>
<u>5"</u>	<u>4"</u>
<u>N 70° W</u>	<u>S 10° W</u>
<u>5.29'</u>	<u>4.11'</u>

Certified corner restoration certificate prepared: Yes _____ No _____

Filed in county records at _____ Date _____ County Document No. _____

Identified on aerial photo No. _____ Which is filed at _____

Index No. 6-21
(Alphabetical - Numerical)

LAND CORNER RECORD
(RECTANGULAR SURVEYS)

R9-7150-4 (Rev. 6/13/67)
GPO 806-924

T. 148 R. 26 Mer. N.F. Chip County Itasca State Minn
1/4 Corner common to sections 11 12 and _____

EXISTING SURVEYS

Original Government Survey
Year surveyed 1875
Original monument sq post
(Wood post, stone, pile of stones, pipe, etc.)

Bearing Trees
Species Tam Tam
Diameter 8" 6"
Bearing N 18W N 87E
Distance 10 LK 5 LK

Subsequent Corner Restoration
Year surveyed 1962 By R. MacDonald, P. Meyer
Where filed or recorded Itasca City
Monument Concrete 6" X 5', bronze cap
(Original, concrete post, iron rod, etc.)

Bearing Trees, Reference Objects
Species _____
Diameter _____
Bearing _____
Distance _____

Original Evidence Found
Year of search 1962 By R. MacDonald
Monument found _____

Original Bearing Trees Found
Species Tam Stump Tam Stp
Diameter 12" 8"
Bearing N 18W N 87E
Distance 10 LK 5 LK
(Scribed)

Evidence of Subsequent Corner Restoration Found
Year of search _____ By _____

Bearing Trees, Reference Objects
Species _____
Diameter _____
Bearing _____
Distance _____

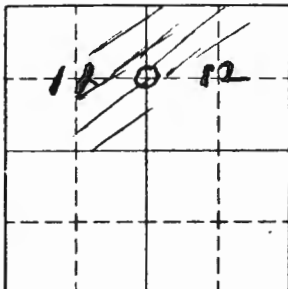

Sketch

○ Corner ▨ F.S. Land

Relation of Evidence to Record Features Along Section Lines

Section line to sections _____
 Object _____
 Record distance _____
 Measured distance _____

Other Evidence

Describe evidence of use and occupation such as roads, fences, clearings, timber cutting lines, plantations, etc.. Cite source of testimony if any. _____

yellow tag on tree, west side of woods road, 1193
 west of 1/4 corner. April 2, 1984 Sk. BA, 2 GR
 BT's good. Red line runs S & E from corner

At time of search:

1. Did you have the record description?

Yes _____ No X

2. How was search area located?

Pacing, chaining, photos, maps,
 etc. _____

3. Man hours spent in search _____

4. Do you think additional search might

recover evidence? Yes _____ No _____

Perpetuation Record

Monument and accessories established. Include brief description of area. _____

monument 6" x 5' set at corner location

This data taken from affidavit on file.

Certified corner restoration certificate prepared: Yes _____ No _____

Filed in county records at _____ Date _____ County Document No. _____

Identified on aerial photo No. _____ Which is filed at _____

Signature

Index No. G-2-1
(Alphabetical - Numerical)

LAND CORNER RECORD
RECTANGULAR SURVEYS

GPO 802-127

T. 148 N R. 26 W Mer. N.F. Chippewa County Itasca State Minnesota
14 Corner common to sections 11 & 12

EXISTING SURVEYS

Original Government Survey

Year surveyed _____
 Original monument _____
(Wood post, stone, pile of stones, pipe, etc.)

Bearing Trees

Species _____
 Diameter _____
 Bearing _____
 Distance _____

Subsequent Corner Restoration

Year surveyed 1962 By U.S.F.S.
 Where filed or recorded _____
 Monument 6" x 5" Concrete Monument
(Original concrete post, iron pipe, etc.)
with brass cap.

Bearing Trees, Reference Objects

Species	<u>Cedar</u>	<u>Cedar</u>	<u>Cedar</u>	<u>steel Post</u>
Diameter	<u>10"</u>	<u>8"</u>	<u>8"</u>	<u>6"</u>
Bearing	<u>S18W</u>	<u>N85W</u>	<u>S28E</u>	<u>East</u>
Distance	<u>29.4'</u>	<u>27.3'</u>	<u>72.6'</u>	<u>6.1'</u>

Original Evidence Found

Year of search _____ By _____
 Monument found _____

Original Bearing Trees Found

Species _____
 Diameter _____
 Bearing _____
 Distance _____

Evidence of Subsequent Corner Restoration Found

Year of search 1980 By R. Olson
 Monument in place

Bearing Trees, Reference Objects

BT's in good condition
160

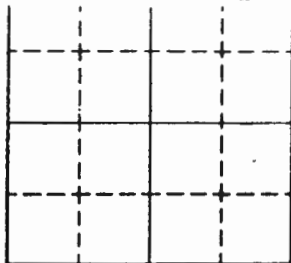

Sketch

Corner F.S. Land

At time of search:

1. Did you have the record description?

Yes _____ No _____

2. How was search area located?

Pacing, chaining, photos, maps,
etc. _____

3. Man hours spent in search _____

4. Do you think additional search might
recover evidence? Yes _____ No _____

5. Signature _____

Section line to sections _____

Object _____

Record distance _____

Measured distance _____

Other Evidence

Describe evidence of use and occupation such as roads, fences, clearings, timber
plantations, etc.. Cite source of testimony if any. _____

Perpetuation Record

Monument and accessories established. Include brief description of area.

July 18, 1983 G. Kasenka, B. Auck G. Robertson
Recovered a 6" diam. concrete monument w/a 3"
diam. B/C stamp: TURN R26W

Batharia BT's recovered
All 1962 BT's recovered

S.11 | S.12
1966
No. 3628

Certified corner restoration certificate prepared: Yes _____ No _____

Filed in county records of _____ Date _____ County Document No. _____

Identified on aerial photo No. _____ Which is filed at _____

Index No. G-23
(Alphabetical - Recorder)

LAND CORNER RECORD
(RECTANGULAR SURVEYS)

RD-7 150-4 (Rev. 6/15/67)
 GPO 802-127

T. 148 R. 26 5th Mer. N.F. Chippewa County Itasca State Ma
1/4 Corner common to sections 12 and _____

EXISTING SURVEYS

Original Government Survey	Original Evidence Found
Year surveyed _____	Year of search _____ By _____
Original monument _____ <small>(Wood post, stone, pile of stones, pipe, etc.)</small>	Monument found _____
Bearing Trees	Original Bearing Trees Found
Species _____	Species _____
Diameter _____	Diameter _____
Bearing _____	Bearing _____
Distance _____	Distance _____

Subsequent Corner Restoration	Evidence of Subsequent Corner Restoration Found
Year surveyed <u>April, 1984</u> By <u>USFS</u>	Year of search _____ By _____
Where filed or recorded <u>Itasca County Court House</u>	_____
Monument <u>Set a 5 ft. long by 2 1/2 in O.D. iron pipe with a 3 in dia. brass cap staped as shown. Up 18" 5° decl.</u>	_____
<small>(Original, concrete post, iron rod, etc.)</small>	_____
	_____

Bearing Trees, Reference Objects				Bearing Trees, Reference Objects			
Species	<u>Tam.</u>	<u>Tam.</u>	<u>Tam.</u>	<u>2 fence posts</u>	_____	_____	_____
Diameter	<u>9.7"</u>	<u>8.3"</u>	<u>10.4"</u>	<u>1 south</u>	_____	_____	_____
Bearing	<u>N47°E</u>	<u>S10°W</u>	<u>N11°W</u>	<u>1 west</u>	_____	_____	_____
Distance	<u>29.42'</u>	<u>6.78'</u>	<u>42.30'</u>	<u>3.0'</u>	_____	_____	_____

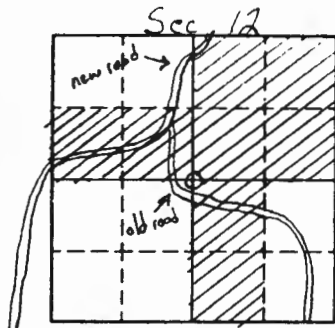

Sketch

O - Corner ▨ F.S. Land

Relation of Evidence to Record Features Along Section Lines

Section line to sections _____
 Object _____
 Record distance _____
 Measured distance _____

Other Evidence

Describe evidence of use and occupation such as roads, fences, clearings, timber cutting lines, plantations, etc.. Cite source of testimony if any. Red line runs E + S from monument. See book 3 Pg 74

At time of search:

1. Did you have the record description?

Yes _____ No _____

2. How was search area located?

Pacing, chaining, photos, maps, etc. _____

3. Man hours spent in search _____

4. Do you think additional search might recover evidence? Yes _____ No _____

Perpetuation Record

Monument and accessories established. Include brief description of area. _____

Certified corner restoration certificate prepared: Yes _____ No _____

Filed in county records of _____ Date _____ County Document No. _____

Index No. G 24
(Alphabetical - Numerical)

LAND CORNER RECORD
(RECTANGULAR SURVEYS)

RS-7 150-4 (Rev. 6/13/67)
GPO 502-127

T. 148 N R. 26 W S^{7A} Mer. N.F. Chippewa County Itasca State Mn
CE 1116 Corner common to sections 12 and

EXISTING SURVEYS

Original Government Survey

Year surveyed _____

Original monument _____
(Wood post, stone, pile of stones, pipe, etc.)

Bearing Trees

Species _____
Diameter _____
Bearing _____
Distance _____

Original Evidence Found

Year of search _____ By _____

Monument found _____

Original Bearing Trees Found

Species _____
Diameter _____
Bearing _____
Distance _____

Subsequent Corner Restoration

Year surveyed March 1984 By USFS

Where filed or recorded Itasca County Courthouse, 148 N. R. 26 W.

Monument Set a 5 ft long by 2 1/2" O.D.

concrete filled galvanized iron pipe
with a 3" dia. brass cap stamped:

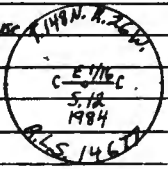

Evidence of Subsequent Corner Restoration Found

Year of search _____ By _____

Bearing Trees, Reference Objects

Species B. Spruce Aspen Tam. 2 metal posts
Diameter 7.7" 8.7" 11.2" 1 E. 3.0'
Bearing S44°E S49°W N26°W 1 S. 3.0'
Distance 56.73' 54.51' 67.08'

All BT's and posts painted red 5° declination

Bearing Trees, Reference Objects

Relation of Evidence to Record Features Along Section Lines

Section line to sections

Object

Record distance

Measured distance

Other Evidence

Describe evidence of use and occupation such as roads, fences, clearings, timber cutting lines, plantations, etc. Cite source of testimony if any. *Red line runs E & S.*

True corner

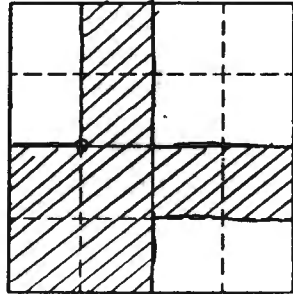

○ Corner F.S. Land

Sketch

At time of search:

1. Did you have the record description? Yes _____ No _____

2. How was search area located? Pacing, chaining, photos, maps, etc. _____

3. Man hours spent in search _____

4. Do you think additional search might recover evidence? Yes _____ No _____

5. Signature _____

Certified corner restoration certificate prepared: Yes _____ No _____

Filed in county records at _____ Date _____ County Document No. _____

Identified on aerial photo No. _____ Which is filed at _____

Perpetuation Record
Monument and accessories established. Include brief description of area.

Index No. G-25
(Alphabetical - Numerical)

LAND CORNER RECORD
(RECTANGULAR SURVEYS)

RD-7 150-4 (Rev. 6/13/67)

GPO 502-127

T. 148 R. 26 5th Mer. N.F. Chippewa County Itasca State MN
 Corner common to sections 12 T148, R26 and 7 T148, R25

EXISTING SURVEYS

Original Government Survey	Original Evidence Found
Year surveyed _____ Original monument _____ <small>(Wood post, stone, pile of stones, pipe, etc.)</small>	Year of search _____ By _____ Monument found _____
<p style="text-align: center;">Bearing Trees</p> Species _____ Diameter _____ Bearing _____ Distance _____	<p style="text-align: center;">Original Bearing Trees Found</p> Species _____ Diameter _____ Bearing _____ Distance _____
<p style="text-align: center;">Subsequent Corner Restoration</p>	<p style="text-align: center;">Evidence of Subsequent Corner Restoration Found</p>
Year surveyed _____ By _____ Where filed or recorded _____ Monument _____ <small>(Original, concrete post, iron rod, etc.)</small>	Year of search <u>11-28-75</u> By <u>S. Moresison</u> <u>Corner is a brass cap. BT is a 5" oak -</u> <u>corner lies 10.9 ft. S. 51° E from BT.</u> <u>Another BT is an 8" Elm, corner lies</u> <u>22.8 ft N 3° W from BT. Another BT is</u> <u>an 8" maple - corner lies 82.7 ft. N</u>
<p style="text-align: center;">Bearing Trees, Reference Objects</p> Species _____ Diameter _____ Bearing _____ Distance _____	<p style="text-align: center;">Bearing Trees, Reference Objects</p> <u>41° E from BT. Corner is visible from</u> <u>woods road.</u>

148 26 148 25

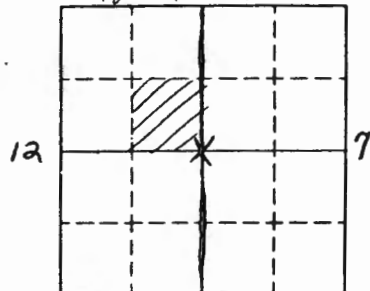

Sketch

O Corner F.S. Land

Relation of Evidence to Record Features Along Section Lines

Section line to sections _____
 Object _____
 Record distance _____
 Measured distance _____

Other Evidence

Describe evidence of use and occupation such as roads, fences, clearings, timber cutting lines, plantations, etc.. Cite source of testimony if any. Red line runs N-W from corner

At time of search:

1. Did you have the record description?

Yes _____ No X

2. How was search area located?

~~Placing~~, chaining, photos, maps,
 etc. _____

3. Man hours spent in search 14. Do you think additional search might recover evidence? Yes _____ No X5. Signature S.M. Morrison

Perpetuation Record

Monument and accessories established. Include brief description of area. March, 1984

USES recovered 6" O.D. concrete monument, Brass cap stamped: F.148 N. R. 26 W. R. 25 W. 74
1961 Elm, 8.6", S02°E, 22.62' to nail in NW face
1961 Elm, 8.1", S40°W, 22.39' to nail in NW face
1961 Oak, 5.0" N54°W, 10.94' to nail in SE face
Est. Birch, 8.5" S65°W, 18.70' to nail in SE face
metal fence post, north, 3.0' w/54-2 sign
metal fence post, west, 3.0' w/54-2, 54-9 signs
All BTs + posts painted red 5° declination

Certified corner restoration certificate prepared: Yes _____ No _____

Filed in county records at _____ Date _____ County Document No. _____

Identified on aerial photo No. _____ Which is filed at _____

Index No. H-15
(Alphabetical - Memorials)

51
40

LAND CORNER RECORD
(RECTANGULAR SURVEYS)

RP-7150-4 (Rev. 6/13/67)
 GPO 802-127

T. 148N R. 26W Mer. N.F. Chippewa County Itasca State Minnesota
Center South 1/16 Corner common to sections 10 and _____

EXISTING SURVEYS

Original Government Survey

Year surveyed _____
 Original monument _____
(Wood post, stone, pile of stones, pipe, etc.)

Bearing Trees

Species _____
 Diameter _____
 Bearing _____
 Distance _____

Subsequent Corner Restoration

Year surveyed 1962 By U.S.F.S.
 Where filed or recorded _____
 Monument 2" x 5" Iron with Brass Cap.
(Original, concrete post, iron rod, etc.)

Bearing Trees, Reference Objects

Species	<u>Spruce</u>	<u>Aspen</u>	<u>Steel Post</u>
Diameter	<u>12"</u>	<u>6"</u>	<u>6"</u>
Bearing	<u>S82E</u>	<u>S41 1/2 W</u>	<u>North</u>
Distance	<u>83.2'</u>	<u>5.85'</u>	<u>4.24'</u>

Original Evidence Found

Year of search _____ By _____
 Monument found _____

Original Bearing Trees Found

Species _____
 Diameter _____
 Bearing _____
 Distance _____

Evidence of Subsequent Corner Restoration Found

Year of search 1961 By R. Stoeser
 Monument in place in place

Bearing Trees, Reference Objects

Species	<u>Spruce</u>	<u>Aspen</u>	<u>Steel Post</u>
Diameter	<u>14"</u>	<u>10"</u>	<u>6"</u>
Bearing	<u>S82E</u>	<u>S41 1/2 W</u>	<u>North</u>
Distance	<u>83.2'</u>	<u>5.85'</u>	<u>4.24'</u>

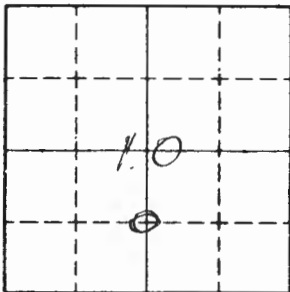

Sketch

○ Corner ▨ F.S. Land

Relation of Evidence to Record Features Along Section Lines

H-1

Section line to sections _____
 Object _____
 Record distance _____
 Measured distance _____

Other Evidence

Describe evidence of use and occupation such as roads, fences, clearings, timber cutting lines, plantations, etc.. Cite source of testimony if any. _____

At time of search:

1. Did you have the record description?
 Yes _____ No _____

2. How was search area located?
 Pacing, chaining, photos, maps,
 etc. _____

3. Man hours spent in search _____

4. Do you think additional search might
 recover evidence? Yes _____ No _____

5. Signature _____

Perpetuation Record

Monument and accessories established. Include brief description of area.
To bring this corner to standard I cut New BT.

*X Rock
 2' x 2 1/2"
 58 W
 35.20'*

*3/11/81
 Ronald Olson*

Certified corner restoration certificate prepared: Yes _____ No _____

Filed in county records of _____ Date _____ County Document No. _____

Identified on aerial photo No. _____ Which is filed at _____

T. 148 N. R. 26+27W Mer. N.F. CHIPPewa County ITASCA State MW
SECTION Corner common to sections 7, 12, 13 and 18

EXISTING SURVEYS

Original Government Survey	Original Evidence Found
Year surveyed _____	Year of search _____ By _____
Original monument _____ <small>(Wood post, stone, pile of stones, pipe, etc.)</small>	Monument found _____
Bearing Trees	Original Bearing Trees Found
Species _____	Species _____
Diameter _____	Diameter _____
Bearing _____	Bearing _____
Distance _____	Distance _____

Subsequent Corner Restoration

Evidence of Subsequent Corner Restoration Found

Year surveyed 1963 By U.S.F.S.
Where filed or recorded _____
Monument 2" x 5" Iron pipe w/ Brass Cap.
(Original, concrete post, man rod, etc.)

Year of search 1-24-80 By Jim Schoonover
Monument and BT's in
Good Condition. Steel sign post
set 49" North of Monument. Original
BT - Elm 36" Elm with location
stickler (1931) N 340W, 2678'.

Bearing Trees, Reference Objects

Bearing Trees, Reference Objects

Species	<u>Ash</u>	<u>Ash</u>	<u>Maple</u>	<u>Elm</u>	<u>Steel post</u>
Diameter	<u>10"</u>	<u>7"</u>	<u>5"</u>	<u>17"</u>	<u>6"</u>
Bearing	<u>N50W</u>	<u>S20W</u>	<u>S57E</u>	<u>N4E</u>	<u>North</u>
Distance	<u>22.7</u>	<u>26.0'</u>	<u>47.6'</u>	<u>48.6</u>	<u>4.9'</u>

Species	<u>Ash</u>	<u>Ash</u>	<u>Maples</u>	<u>Elm</u>
Diameter	<u>12"</u>	<u>9"</u>	<u>6"</u>	<u>20"</u>
Bearing	<u>N50W</u>	<u>S20W</u>	<u>S57E</u>	<u>N210E</u>
Distance	<u>22.7'</u>	<u>26.0'</u>	<u>47.6'</u>	<u>48.6'</u>

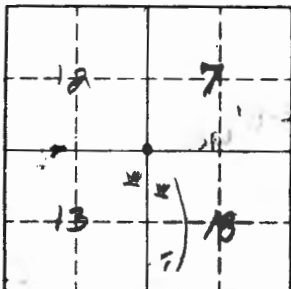

Sketch

○ Corner ▨ F.S. Land

Relation of Evidence to Record Features Along Section Lines

Section line to sections _____
 Object _____
 Record distance _____
 Measured distance _____

Other Evidence

Describe evidence of use and occupation such as roads, fences, clearings, timber cutting lines, plantations, etc.. Cite source of testimony if any. _____

At time of search:

1. Did you have the record description?

Yes _____ No _____

2. How was search area located?

Pacing, chaining, photos, maps, etc. _____

3. Man hours spent in search _____

4. Do you think additional search might recover evidence? Yes _____ No _____

5. Signature _____

Perpetuation Record

Monument and accessories established. Include brief description of area. _____

*Set Stake post with name SH-2-54-4
 30' SOUTH OF MONUMENT*

Certified corner restoration certificate prepared: Yes _____ No _____

Filed in county records at _____ Date _____ County Document No. _____

Identified on aerial photo No. _____ Which is filed at _____

Index No. J-21
(Alphabetical - Numerical)

LAND CORNER RECORD
(RECTANGULAR SURVEYS)

R9-7 150-4 (Rev. 6/13/67)
 GPO 502-127

T. 148 N R. 26 W 5th Mer. N.F. Chippewa County Itasca State Mn
Section Corner common to sections 11, 12, 13 and 14

EXISTING SURVEYS

Original Government Survey

Year surveyed _____

Original monument _____
(Wood post, stone, pile of stones, pipe, etc.)

Bearing Trees

Species _____

Diameter _____

Bearing _____

Distance _____

Original Evidence Found

Year of search _____ By _____

Monument found _____

Original Bearing Trees Found

Species _____

Diameter _____

Bearing _____

Distance _____

Subsequent Corner Restoration

Year surveyed _____ By _____

Where filed or recorded _____

Monument _____
(Original, concrete post, iron rod, etc.)

Evidence of Subsequent Corner Restoration Found

Year of search May 1984 By USFS

Recovered a concrete monument
with a 3" dia brass cap stamped:
Under road surface 1 to 3 ft.
2.3 ft. S. of E. Co. Rd. #4

T148 N R26 W
 S. 11 | S. 12
 S. 14 | S. 13
 1963
 P.L.S. 6001

Bearing Trees, Reference Objects

Species _____

Diameter _____

Bearing _____

Distance _____

Bearing Trees, Reference Objects

<u>R. Oak</u>	<u>R. Oak</u>	<u>R. Oak</u>	<u>R. Oak</u>
<u>11.9 in.</u>	<u>14.3 in.</u>	<u>12.4 in.</u>	<u>8.6 in.</u>
<u>N 08° E</u>	<u>S 73° E</u>	<u>S 47° W</u>	<u>N 25° W</u>
<u>85.56'</u>	<u>208.90'</u>	<u>76.80'</u>	<u>93.00'</u>

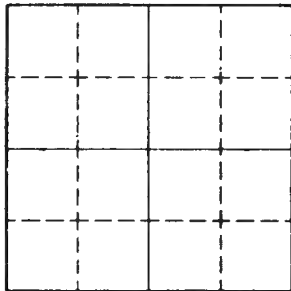

Sketch

○ Corner ▨ F.S. Land

Relation of Evidence to Record Features Along Section Lines

Section line to sections _____
Object _____
Record distance _____
Measured distance _____

Other Evidence

Describe evidence of use and occupation such as roads, fences, clearings, timber cutting lines, plantations, etc.. Cite source of testimony if any. _____

At time of search:

1. Did you have the record description?

Yes _____ No _____

2. How was search area located?

Pacing, chaining, photos, maps,
etc. _____

3. Man hours spent in search _____

4. Do you think additional search might

recover evidence? Yes _____ No _____

Perpetuation Record

Monument and accessories established. Include brief description of area. _____

Certified corner restoration certificate prepared: Yes _____ No _____

Filed in county records at _____ Date _____ County Document No. _____

5. Signature Kenneth L. White Identified on aerial photo No. _____ Which is filed at _____

Index No. J-23
(Alphabetical - Numerical)

LAND CORNER RECORD
(RECTANGULAR SURVEYS)

RD-7150-4 (Rev. 6/13/67)
 GPO 802-127

T. 148 N R. 26 W 1/4 Mer. N.F. Chippewa County Wasco State Mn
 Corner common to sections _____, _____, _____ and 13

EXISTING SURVEYS

Original Government Survey

Year surveyed _____
 Original monument _____
(Wood post, stone, pile of stones, pipe, etc.)

Bearing Trees

Species _____
 Diameter _____
 Bearing _____
 Distance _____

Subsequent Corner Restoration

Year surveyed _____ By _____
 Where filed or recorded _____
 Monument _____
(Original, concrete post, iron rod, etc.)

Bearing Trees, Reference Objects

Species _____
 Diameter _____
 Bearing _____
 Distance _____

Original Evidence Found

Year of search _____ By _____
 Monument found _____

Original Bearing Trees Found

Species _____
 Diameter _____
 Bearing _____
 Distance _____

Evidence of Subsequent Corner Restoration Found

Year of search May, 1984 By USFS
Recovered a 3" dia. brass cap
stump as shown:
3 in. below E Cor. Rd #4

148N 26W
 1/4 S. 12
 S. 13
 1963
 R.L.S. 6807

Bearing Trees, Reference Objects

<u>Tom (dead)</u>	<u>Tom (dead)</u>	<u>R. Pine</u>	<u>4 x 4</u>
<u>stump</u>	<u>stump</u>	<u>7.2"</u>	<u>Red top</u>
<u>N 52° E</u>	<u>S 60° E</u>	<u>S 33° W</u>	<u>North</u>
<u>122.85'</u>	<u>129.30'</u>	<u>70.66'</u>	<u>73.30'</u>

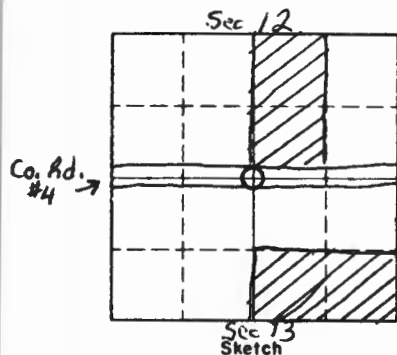

○ Corner ▨ F.S. Land

Relation of Evidence to Record Features Along Section Lines

Section line to sections _____
 Object _____
 Record distance _____
 Measured distance _____

Other Evidence

Describe evidence of use and occupation such as roads, fences, clearings, timber cutting lines, plantations, etc.. Cite source of testimony if any. *Monument is 113 ft East of Rd. intersection with sanitary landfill Rd. Red line runs north from corner*

At time of search:

1. Did you have the record description?

Yes _____ No _____

2. How was search area located?

Pacing, chaining, photos, maps, etc. _____

3. Man hours spent in search _____

4. Do you think additional search might recover evidence? Yes _____ No _____

5. Signature _____

[Handwritten signature]

Perpetuation Record

Monument and accessories established. Include brief description of area. _____

Certified corner restoration certificate prepared: Yes _____ No _____

Filed in county records of _____ Date _____ County Document No. _____

Identified on aerial photo No. _____ Which is filed at _____

Index No. V-25
(Alphabetical - Numerical)

LAND CORNER RECORD
(RECTANGULAR SURVEYS)

RR-7150-4 (Rev. 6/13/67)
 GPO 802-127

T. 148 N. R. 26 W 5th Mer. N.F. Chippewa County Itasca State Ma
Section Corner common to sections 12, 13, 7 and 18

EXISTING SURVEYS

Original Government Survey

Year surveyed _____
 Original monument _____
(Wood post, stone, pile of stones, pipe, etc.)

Bearing Trees

Species _____
 Diameter _____
 Bearing _____
 Distance _____

Original Evidence Found

Year of search _____ By _____
 Monument found No original Evidence left

Original Bearing Trees Found

Species _____
 Diameter _____
 Bearing _____
 Distance _____

Subsequent Corner Restoration

Year surveyed 1981 By Itasca Court
 Where filed or recorded _____
 Monument 1" iron pin 12" under side road surface
(Original, concrete post, iron rod, etc.)

Evidence of Subsequent Corner Restoration Found

Year of search 1984 By USFS
All BT's in good shape
Set a metal fence post 3.0' South of witness corner. All BT's and post painted red
See Book 3 Pg 8 T 148 N R 26 W

Bearing Trees, Reference Objects

Species	<u>power pole N. Pine</u>	<u>N. Pine</u>	<u>Co. Mon.</u>
Diameter	<u>14"</u>	<u>8"</u>	<u>wp 3'</u>
Bearing	<u>N 39° W</u>	<u>N 04° E</u>	<u>South</u>
Distance	<u>44.39'</u>	<u>89.85'</u>	<u>72.18'</u>
	<u>X on culvert E 12.5'</u>	<u>X on culvert W 16.77'</u>	

Bearing Trees, Reference Objects

Species	_____	_____	_____
Diameter	_____	_____	_____
Bearing	_____	_____	_____
Distance	_____	_____	_____

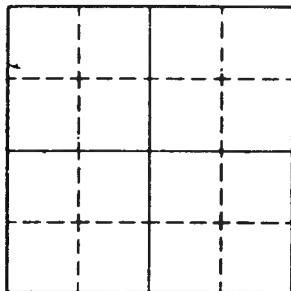

Sketch

○ Corner ▨ F.S. Land

Relation of Evidence to Record Features Along Section Lines

Section line to sections _____
Object _____
Record distance _____
Measured distance _____

Other Evidence

Describe evidence of use and occupation such as roads, fences, clearings, timber cutting lines, plantations, etc.. Cite source of testimony if any. _____

At time of search:

1. Did you have the record description?

Yes _____ No _____

2. How was search area located?

Pacing, chaining, photos, maps, etc. _____

3. Man hours spent in search _____

4. Do you think additional search might recover evidence? Yes _____ No _____

Perpetuation Record

Monument and accessories established. Include brief description of area. _____

Certified corner restoration certificate prepared: Yes _____ No _____

Filed in county records at _____ Date _____ County Document No. _____

Identified on aerial photo No. _____ Which is filed at _____

5. Signature _____

T 148 R 26 Mer. N.F. CHIPPENAW County ITASCA State MN
 Corner common to sections 17 and _____

EXISTING SURVEYS

Original Government Survey

Year surveyed _____
 Original monument _____
(Wood post, stone, pile of stones, post, etc.)

Bearing Trees

Species	<u>WPine</u>	<u>WPine</u>
Diameter	<u>3 1/2"</u>	<u>3 1/2"</u>
Bearing	<u>S 12° W</u>	<u>S 71° W</u>
Distance	<u>83.4'</u>	<u>73.9'</u>

Original Evidence Found

Year of search _____ By RA McDonald
 Monument found Iron 1" pipe

Original Bearing Trees Found

Species	<u>WPine</u>	<u>WPine</u>
Diameter	<u>Stump</u>	<u>Stump</u>
Bearing	<u>S 19° W</u>	<u>S 61° W</u>
Distance	<u>83.4'</u>	<u>73.9'</u>

Subsequent Corner Restoration

Year surveyed 1962 By RA McDonald
 Where filed or recorded _____
 Monument 3" Iron pipe with BRASS CAP
(Original, concrete post, iron rod, etc.)

Evidence of Subsequent Corner Restoration Found

Year of search 1979 Jan By JIM SCHOONOVER
MONUMENT in GOOD condition

Bearing Trees, Reference Objects

Species	<u>WSPRUCE</u>	<u>OAK</u>	<u>CEDAR</u>
Diameter	<u>4"</u>	<u>5"</u>	<u>8"</u>
Bearing	<u>S 75° E</u>	<u>S 22 1/2° E</u>	<u>S 75° W</u>
Distance	<u>55.6'</u>	<u>36.35'</u>	<u>105.05'</u>

Bearing Trees, Reference Objects

Species	<u>OAK</u>	<u>CEDAR</u>
Diameter	<u>7"</u>	<u>Stump</u>
Bearing	<u>S 22 1/2° E</u>	<u>S 75° W</u>
Distance	<u>36.35'</u>	<u>105.05'</u>

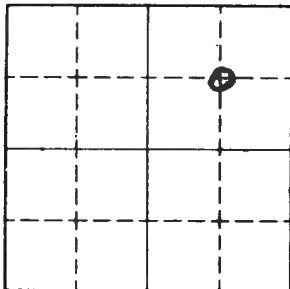

Sketch

○ Corner ▨ F.S. Land

Relation of Evidence to Record Features Along Section Lines

Section line to sections _____
 Object _____
 Record distance _____
 Measured distance _____

Other Evidence

Describe evidence of use and occupation such as roads, fences, clearings, timber cutting lines, plantations, etc.. Cite source of testimony if any. _____

NEEDS 2 NEW BITS

At time of search:

1. Did you have the record description?

Yes _____ No _____

2. How was search area located?

Pacing, chaining, photos, maps, etc. _____

3. Man hours spent in search _____

4. Do you think additional search might recover evidence? Yes _____ No _____

5. Signature _____

Perpetuation Record

Monument and accessories established. Include brief description of area. _____

SET STEEL POST with sign 54.2, 54.9
 2.55' DWE WEST OF Monument

Certified corner restoration certificate prepared: Yes _____ No _____

Filed in county records at _____ Date _____ County Document No. _____

Identified on aerial photo No. _____ Which is filed at _____

T. 148N R. 26W Mer. N.F. Chippewa County Itasca State MINN.
Center North 1/16 Corner common to sections 14 and _____

EXISTING SURVEYS

Original Government Survey

Year surveyed _____
 Original monument _____
(Wood post, stone, pile of stones, pipe, etc.)

Bearing Trees

Species _____
 Diameter _____
 Bearing _____
 Distance _____

Subsequent Corner Restoration

Year surveyed 1918 By Itasca Co. Surveyor
 Where filed or recorded Co. Courthouse
 Monument Iron pipe
(Original, concrete post, iron rod, etc.)

Bearing Trees, Reference Objects

Species Maple Poplar
 Diameter 7" 18"
 Bearing N85°W S42½E
 Distance 22.6' 22.8'

Original Evidence Found

Year of search _____ By _____
 Monument found _____

Original Bearing Trees Found

Species _____
 Diameter _____
 Bearing _____
 Distance _____

Evidence of Subsequent Corner Restoration Found

Year of search 1962 By R.H. McDonald
Found a 3/4" dia. iron pipe marking corner.

stump Aspen windfall
N78°W S35½E
22.6' 22.8'

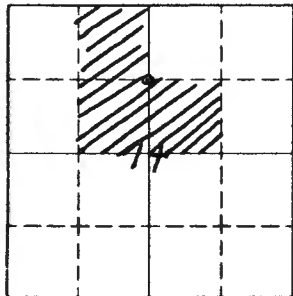

Sketch

○ Corner F.S. Land

Relation of Evidence to Record Features Along Section Lines

Section line to sections -----
 Object -----
 Record distance -----
 Measured distance -----

Other Evidence

Describe evidence of use and occupation such as roads, fences, clearings, timber cutting lines, plantations, etc.. Cite source of testimony if any. S-15-85 ROSENKO ANSK ROBERTSON

Found 2" dia. iron pipe with brass cap
S. Maple 13.9" N44°E 30.58' w/60d spike
S. Maple 10" S72°W 36.87' w/60d spike
S. Maple 92" N63°W 52.22' w/60d spike
Metal Fence Post North 3.4' w/54-2 & 54-4
Est. Chrysonite Boundary Marker, East, 3.0 ft

Perpetuation Record
 Monument and accessories established. Include brief description of area.

Set a 2" dia. iron pipe w/ brass cap stamped:- T198NR2W
Maple 12" N44½°E 30.3' N 1/16 1514
Maple 10" S72½°W 36.7' 1962
Maple 7" N69½°W 52.4' RLS NO 3628
Steel post with signs 54-2 & 54-4 attached
set due North 3.93'

Certified corner restoration certificate prepared: Yes No _____
 Filled in county records at Grand Rapids Date _____ County Document No _____

- At time of search:
- Did you have the record description?
 Yes No _____
 - How was search area located?
 Pacing, chaining, photos, maps, etc. _____
 - Man hours spent in search _____
 - Do you think additional search might recover evidence? Yes _____ No _____

Index No. K-23
(Alphabetical - Numerical)

LAND CORNER RECORD
(RECTANGULAR SURVEYS)

Re-7 100-4 (Rev. 6/13/67)
 GPO 802-127

T. 148 N. R. 26 W 5th Mer. N.F. Chippewa County Hasca State Mo.
CU 1/16 Corner common to sections 13 and _____

EXISTING SURVEYS

Original Government Survey

Year surveyed _____
 Original monument _____
(Wood post, stone, pile of stones, pipe, etc.)

Bearing Trees

Species _____
 Diameter _____
 Bearing _____
 Distance _____

Subsequent Corner Restoration

Year surveyed: March, 1984 By USFS
 Where filed or recorded Hasca County Court House
 Monument Set a 5 ft long by 2 1/2" O.D. concrete
(Original, concrete post, was 1 1/2" dia)
filled galvanized iron pipe. 3" dia brass cap
stamped as shown. Up 1.5 ft

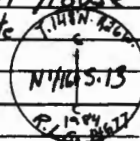

Bearing Trees, Reference Objects

Species Aspen B. of G. metal post 2 metal posts
 Diameter 10.5" 7.2" _____ 1 E. 3.0"
 Bearing S 45° E S 50° W N 18° E 1 S. 3.0'
 Distance 83.49' 20.09' 32.34'
All OT's & posts painted red 5° declination

Original Evidence Found

Year of search _____ By _____
 Monument found _____

Original Bearing Trees Found

Species _____
 Diameter _____
 Bearing _____
 Distance _____

Evidence of Subsequent Corner Restoration Found

Year of search _____ By _____

Bearing Trees, Reference Objects

Species _____
 Diameter _____
 Bearing _____
 Distance _____

Relation of Evidence to Record Features Along Section Lines

Section line to sections	Object	Record distance	Measured distance
_____	_____	_____	_____
_____	_____	_____	_____
_____	_____	_____	_____

Other Evidence

Describe evidence of use and occupation such as roads, fences, clearings, timber cutting lines, plantations, etc. Cite source of testimony if any. *Corner is in Swamp*
1st fall on old woods road. Red line runs E & S from corner

Perpetuation Record

Monument and accessories established. Include brief description of area. _____

Certified corner restoration certificate prepared: Yes _____ No _____
 Filed in county records at _____ Date _____
 Identified on aerial photo No. _____ which is filed at _____
 County Document No. _____

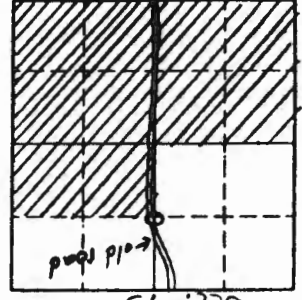

Sketch
 O Corner F.S. Land

At time of search:
 1. Did you have the record description? Yes _____ No _____

2. How was search area located? _____

 Pacing, chaining, photos, maps, _____
 etc. _____

3. How many hours spent in search _____

4. Do you think additional search might recover evidence? Yes _____ No _____

5. Signature _____

Index No. K 25
(Alphabetical - Numerical)

LAND CORNER RECORD
(RECTANGULAR SURVEYS)

79-7180-4 (Rev. 6/13/67)
 GPO 806-924

T. 148 N R. 26 W 5th Mer. N.F. Chippewa County State Minn
N 1/16 Corner common to sections 15 and _____

EXISTING SURVEYS

Original Government Survey

Year surveyed 1927 By P.C. Warner
 Original monument 1" iron pipe
(Wood post, stone, pile of stones, pop, etc.)

Bearing Trees

Species	<u>Tam</u>	<u>Cedar</u>
Diameter	<u>7"</u>	<u>8"</u>
Bearing	<u>N 66° W</u>	<u>S 44° W</u>
Distance	<u>45.8'</u>	<u>48.5'</u>

Subsequent Corner Restoration

Year surveyed _____ By _____
 Where filed or recorded _____
 Monument _____
(Original, concrete post, iron rod, etc.)

Bearing Trees, Reference Objects

Species	_____
Diameter	_____
Bearing	_____
Distance	_____

Original Evidence Found

Year of search 1961 By R.H. McDonald
 Monument found 1" iron pipe
set a 2" dia. 5' long monument stamped:

Original Bearing Trees Found

Species	<u>Tam</u>	<u>Cedar</u>
Diameter	_____	_____
Bearing	<u>N 55° W</u>	<u>S 52° W</u>
Distance	<u>45.8'</u>	<u>48.5'</u>

(Circular stamp)
 T. 148 N.
 R. 26 W. S. 25 W.
 N. 1/16
 S. 13 S. 18
 P.C. 1961
 S. 112.3628

Evidence of Subsequent Corner Restoration Found

Year of search 1961 By _____
Established
W. Spruce, 9", S 74° W, 44.2'
Birch, 5", S 15 1/2° E, 42.75'
Cedar post

Bearing Trees, Reference Objects

Species	_____
Diameter	_____
Bearing	_____
Distance	_____

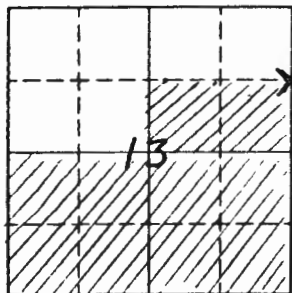

Sketch

○ Corner ▨ F.S. Land

Relation of Evidence to Record Features Along Section Lines

Section line to sections _____
 Object _____
 Record distance _____
 Measured distance _____

Other Evidence

Describe evidence of use and occupation such as roads, fences, clearings, timber cutting lines, plantations etc.. Cite source of testimony if any. Corner consists of a brass cap BT is 6" Birch corner lies N 15 1/2° W 42.75 ft
another BT is a 11" Spruce corner lies N 74° E 44.2 ft
Blue line painted W & S from corner
1984 - Red line runs W & S from corner
All BT's painted red

At time of search:

1. Did you have the record description?

Yes _____ No _____

2. How was search area located?

Pacing, chaining, photos, maps, etc. _____

3. Man hours spent in search _____

4. Do you think additional search might recover evidence? Yes _____ No _____

Perpetuation Record See also BK 3 P 9⁵

Monument and accessories established. Include brief description of area. _____

March 1984, USFS

Found 1961 monument from which bears:

1927 cedar stake, S 61° W, 48.95' to nail in SE face
1961 wht Birch, 6.8", S 14° E, 42.81' to nail in NE face
1961 wht Spruce, 12.7", S 78° W, 44.24' to nail in North face
1981 wht Birch, 10.1", S 88° E, 7.32' to nail in South face
1981 wht Spruce, 12.6", N 04° W, 33.78' to nail in East face
1981 Ash, 7.1", S 14° W, 46.53' to nail in SE face

Certified corner restoration certificate prepared: Yes _____ No _____

Filed in county records at _____ Date _____ County Document No. _____

5. Signature 3-28-73 SAM, LM

Identified on aerial photo No. _____ Which is filed at _____

T. 148N R. 26W + 27W S. 5+N Mer. N.F. CA Appona County ITASCIA State MW
13 18
 Corner common to sections 13 18 and

EXISTING SURVEYS

Original Government Survey	Original Evidence Found
Year surveyed _____	Year of search _____ By _____
Original monument _____ <small>(Wood post, stone, pile of stones, pipe, etc.)</small>	Monument found _____
Bearing Trees	Original Bearing Trees Found
Species _____	Species _____
Diameter _____	Diameter _____
Bearing _____	Bearing _____
Distance _____	Distance _____
Subsequent Corner Restoration	Evidence of Subsequent Corner Restoration Found
Year surveyed <u>1963</u> By <u>U.S.F.S.</u>	Year of search <u>1-21-80</u> By <u>Jim Schoenauk</u>
Where filed or recorded _____	
Monument <u>6" x 2" concrete w/ Brass cap</u> <small>(Original, concrete post, iron rod, etc.)</small>	<u>Monument + BT's IN GOOD</u> <u>Condition. - 1 OAK POST 4" x 4" x 72"</u> <u>14.3' NORTH of Monument.</u> <u>Monument 2" BELOW ROAD SURFACE</u>
Bearing Trees, Reference Objects	Bearing Trees, Reference Objects
Species <u>Oak</u> <u>Elm</u> <u>Oak</u> <u>wood post</u>	<u>OAK</u> <u>ELM</u> <u>OAK</u> _____
Diameter <u>5"</u> <u>6"</u> <u>6"</u> <u>4x4</u>	<u>6"</u> <u>9"</u> <u>9"</u> _____
Bearing <u>N34E</u> <u>S74E</u> <u>S42°W</u> <u>North</u>	<u>N34°E</u> <u>S74°E</u> <u>S42°W</u> _____
Distance <u>83.1</u> <u>82.8'</u> <u>82.4</u> <u>14.3'</u>	<u>83.1'</u> <u>82.8'</u> <u>82.4'</u> _____

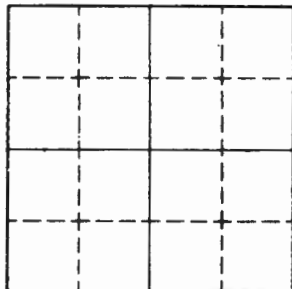

Sketch

○ Corner ▨ F.S. Land

Relation of Evidence to Record Features Along Section Lines

Section line to sections _____

Object _____

Record distance _____

Measured distance _____

Other Evidence

Describe evidence of use and occupation such as roads, fences, clearings, timber cutting lines, plantations, etc.. Cite source of testimony if any. _____

At time of search:

1. Did you have the record description?

Yes _____ No _____

2. How was search area located?

Pacing, chaining, photos, maps, etc. _____

3. Man hours spent in search _____

4. Do you think additional search might recover evidence? Yes _____ No _____

5. Signature _____

Perpetuation Record

Monument and accessories established. Include brief description of area. _____

Certified corner restoration certificate prepared: Yes _____ No _____

Filed in county records at _____ Date _____ County Document No. _____

Identified on aerial photo No. _____ Which is filed at _____

T. 14 8 R. 26 S. 5 Mer. N.F. Chippewa County ITASCA State MN
CE 1/6 Corner common to sections 17 and _____

EXISTING SURVEYS

Original Government Survey

Year surveyed _____
Original monument _____
(Wood post, stone, pile of stones, pipe, etc.)

	Bearing Trees	
Species	<u>W Pine</u>	<u>W Pine</u>
Diameter	<u>36"</u>	<u>24"</u>
Bearing	<u>N28°W</u>	<u>N74°E</u>
Distance	<u>56.00'</u>	<u>90.5'</u>

Subsequent Corner Restoration

Year surveyed 1962 By RH McDonald
Where filed or recorded ITASCA
Monument 2" Iron pipe with brass cap
(Original, concrete post, iron rod, etc.)

STEEL sign post 3.55' E of monument

Bearing Trees, Reference Objects

Species	<u>ELM</u>	<u>Aspen</u>
Diameter	<u>4"</u>	<u>8"</u>
Bearing	<u>S52°W</u>	<u>N20 1/2°W</u>
Distance	<u>36.0'</u>	<u>24.4'</u>

Original Evidence Found

Year of search 1962 By RH McDonald
Monument found Iron pipe 1"

Original Bearing Trees Found

Species	<u>W Pine</u>	<u>W Pine</u>
Diameter	<u>Stump</u>	<u>Stump</u>
Bearing	<u>N22°W</u>	<u>N65°E</u>
Distance	<u>56.0'</u>	<u>95.0'</u>

Evidence of Subsequent Corner Restoration Found

Year of search 1969 By Jim Schoonover

Dead

Bearing Trees, Reference Objects

Species	<u>ELM</u>	<u>Aspen</u>
Diameter	<u>6"</u>	<u>13"</u>
Bearing	<u>S52°W</u>	<u>N20 1/2°W</u>
Distance	<u>36.0'</u>	<u>24.4'</u>

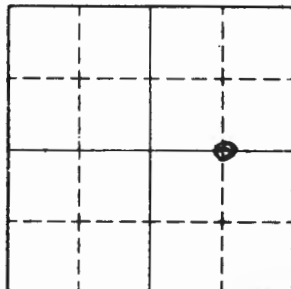

Sketch

○ Corner ▨ F.S. Land

Relation of Evidence to Record Features Along Section Lines

Section line to sections _____
 Object _____
 Record distance _____
 Measured distance _____

Other Evidence

Describe evidence of use and occupation such as roads, fences, clearings, timber cutting lines, plantations, etc.. Cite source of testimony if any. _____

NEEDS 2 NEW BTs

At time of search:

1. Did you have the record description?

Yes _____ No _____

2. How was search area located?

Pacing, chaining, photos, maps, etc. _____

3. Man hours spent in search _____

4. Do you think additional search might recover evidence? Yes _____ No _____

5. Signature _____

Perpetuation Record

Monument and accessories established. Include brief description of area. _____

Certified corner restoration certificate prepared: Yes _____ No _____

Filed in county records at _____ Date _____ County Document No. _____

Identified an aerial photo No. _____ Which is filed at _____

Index No. L-20
(Alphabetical - Numerical)

LAND CORNER RECORD
5 (RECTANGULAR SURVEYS)

RD-7150-4 (Rev. 6/13/67)

ASPO 908-127

T. 149 R. 26 S. 5 Mer. N.F. CHIPPENAW County ITASCA State MN
CEKb Corner common to sections 14 and _____

EXISTING SURVEYS

Original Government Survey

Year surveyed _____
Original monument _____
(Wood post, stone, pile of stones, pipe, etc.)

Bearing Trees

Species _____
Diameter _____
Bearing _____
Distance _____

Subsequent Corner Restoration

Year surveyed. 1963 By McDonald
Where filed or recorded _____
Monument Concrete in ROAD
(Original, concrete post, iron rod, etc.)

Bearing Trees, Reference Objects

Species OAK ELM
Diameter 14" 9"
Bearing S 72 1/2° W N 64° W
Distance 48.4' 36.25'

Original Evidence Found

Year of search _____ By _____
Monument found _____

Original Bearing Trees Found

Species _____
Diameter _____
Bearing _____
Distance _____

Evidence of Subsequent Corner Restoration Found

Year of search 1979 By J. Schwaner

Bearing Trees, Reference Objects

Species OAK ELM
Diameter 11" 9"
Bearing S 72 1/2° W N 64° W
Distance 48.4' 36.25'

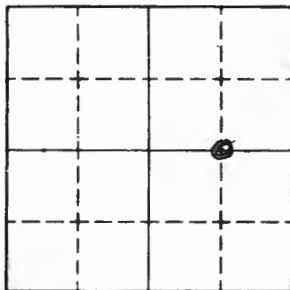

Sketch

○ Corner ▨ F.S. Land

Relation of Evidence to Record Features Along Section Lines

Section line to sections _____
 Object _____
 Record distance _____
 Measured distance _____

Other Evidence

Describe evidence of use and occupation such as roads, fences, clearings, timber cutting lines, plantations, etc.. Cite source of testimony if any. _____

NEEDS / NEW BT

At time of search:

1. Did you have the record description?

Yes _____ No _____

2. How was search area located?

Pacing, chaining, photos, maps, etc. _____

3. Man hours spent in search _____

4. Do you think additional search might recover evidence? Yes _____ No _____

5. Signature _____

Perpetuation Record

Monument and accessories established. Include brief description of area. _____

Certified corner restoration certificate prepared: Yes _____ No _____

Filed in county records at _____ Date _____ County Document No. _____

Identified on aerial photo No. _____ Which is filed at _____

Index No. 1-23
(Alphabetical - Numerical)

LAND CORNER RECORD
(RECTANGULAR SURVEYS)

RD-7150-4 (Rev. 6/15/67)
 GPO 802-127

T. 148 N. R. 26 W 5th Mer. N.F. Chippewa County Nebraska State Ne
C/4 Corner common to sections 13 and _____

EXISTING SURVEYS

Original Government Survey	Original Evidence Found
Year surveyed _____	Year of search _____ By _____
Original monument _____ <small>(Wood post, stone, pile of stones, pipe, etc.)</small>	Monument found _____
Bearing Trees	Original Bearing Trees Found
Species _____	Species _____
Diameter _____	Diameter _____
Bearing _____	Bearing _____
Distance _____	Distance _____

Subsequent Corner Restoration	Evidence of Subsequent Corner Restoration Found
Year surveyed <u>March 1984</u> By <u>USFS</u>	Year of search _____ By _____
Where filed or recorded <u>Nebraska County Court House</u>	_____
Monument <u>Set a 5 ft long by 2 1/2 in.</u> <u>O.D. concrete filled iron pipe with</u> <u>a 3" diameter brass cap stapd:</u> <u>Up 18 inches</u>	_____
	_____
Bearing Trees, Reference Objects	Bearing Trees, Reference Objects
Species <u>W. Spruce</u> <u>W. Spruce</u> <u>W. Spruce</u> <u>2 metal posts</u>	_____
Diameter <u>10.1"</u> <u>10.4"</u> <u>9.7"</u> <u>1 N. 3.0'</u>	_____
Bearing <u>S53°E</u> <u>S94°W</u> <u>N13°W</u> <u>1 W. 3.0'</u>	_____
Distance <u>63.02'</u> <u>39.47'</u> <u>57.85'</u> _____	_____
<u>All trees & posts oriented red</u>	_____

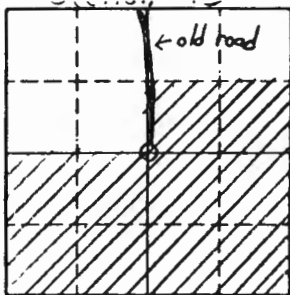

Sketch

○ Corner ▨ F.S. Land

Relation of Evidence to Record Features Along Section Lines

Section line to sections _____
 Object _____
 Record distance _____
 Measured distance _____

Other Evidence

Describe evidence of use and occupation such as roads, fences, clearings, timber cutting lines, plantations, etc.. Cite source of testimony if any.

There is red line going N. & W. from the corner. Corner can be reached by an old road coming in from the North

At time of search:

1. Did you have the record description?

Yes _____ No _____

2. How was search area located?

Pacing, chaining, photos, maps, etc. _____

3. Man hours spent in search _____

4. Do you think additional search might recover evidence? Yes _____ No _____

5. Signature _____

Perpetuation Record

Monument and accessories established. Include brief description of area. _____

Certified corner restoration certificate prepared: Yes _____ No _____

Filed in county records at _____ Date _____ County Document No. _____

Identified on aerial photo No. _____ Which is filed at _____

Index No. 4-25
(Alphabetical - Numerical)

LAND CORNER RECORD
(RECTANGULAR SURVEYS)

R9-7 150-4 (Rev. 6/15/67)

GPO 806-924

T. 148 N R. 26 W 5th Mer. N.F. Chippewa County State Maine
45 Corner common to sections 13 and _____

EXISTING SURVEYS

Original Government Survey

Year surveyed ?
 Original monument wand
(Wood post, stone, pile of stones, pipe, etc.)

Bearing Trees

Species Aspen Aspen
 Diameter _____
 Bearing _____
 Distance _____

Subsequent Corner Restoration

Year surveyed _____ By _____
 Where filed or recorded _____
 Monument _____
(Original, concrete post, iron rod, etc.)

Bearing Trees, Reference Objects

Species _____
 Diameter _____
 Bearing _____
 Distance _____

Original Evidence Found

Year of search 1961 By USFS
 Monument found original post paint

Original Bearing Trees Found Established

Species W. Spruce W. Spruce W. Spruce
 Diameter 6" 4" 6"
 Bearing N21°W S01°E N84°E
 Distance 44.2' 37.35' 60.9'

Evidence of Subsequent Corner Restoration Found

Year of search _____ By _____

Bearing Trees, Reference Objects

Species _____
 Diameter _____
 Bearing _____
 Distance _____

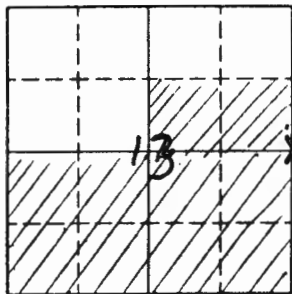

Sketch

○ Corner ▨ F.S. Land

At time of search:

1. Did you have the record description?

Yes _____ No _____

2. How was search area located?

Pacing, chaining, photos, maps, etc. _____

3. Man hours spent in search _____

4. Do you think additional search might recover evidence? Yes _____ No _____

Relation of Evidence to Record Features Along Section Lines

Section line to sections _____
 Object _____
 Record distance _____
 Measured distance _____

Other Evidence

Describe evidence of use and occupation such as roads, fences, clearings, timber cutting lines, plantations, etc.. Cite source of testimony if any. Corner is a brass cap

BT is a 10" spruce corner lies $S 21^{\circ} E$ 44.2 ft another
 BT is a 7" spruce corner lies $N 1^{\circ} W$ 33.5 ft BT is
 a 10" spruce corner lies $S 84^{\circ} W$ 50.9 ft FSLP tag on
 S side of 10" spruce corner lies 8 ft SE of tag Blue
 line painted N-S from corner 1984 red line
 painted N & E from corner

Perpetuation Record

Monument and accessories established. Include brief description of area. March, 1984

USFS recovered monument up 1.3' brass cap stamped: T.148.N.
R26W R25W
 All BT's and posts painted red
 1961 Spruce, 11.6", $N 86^{\circ} E$, 60.75' to nail in N face
 1961 Spruce, 10.0", $S 93^{\circ} W$, 37.16' to nail in W face
 1961 Spruce, 12.1", $N 30^{\circ} W$, 43.95' to nail in NE face
 1981 Spruce, 11.4", $N 32^{\circ} E$, 14.75' to nail in E face
 Metal fence post, east, 3.0', w/54-2 + 54-9 signs
 Metal fence post, north, 3.0', w/54-2 sign 5° decl. no. 1

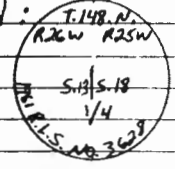

Certified corner restoration certificate prepared: Yes _____ No _____

Filed in county records at _____ Date _____ County Document No. _____

Identified on aerial photo No. _____ Which is filed at _____

Signature _____

Index No. N-1
(Alphabetical-Numeral)Book #2
Page #5LAND CORNER RECORD
(RECTANGULAR SURVEYS)

NR-7 150-4 (Rev. 6/13/67)

GPO 502-127

T. 148 N. 26 W 27 W 5th Mer. N.F. CHIPPewa County TRASCA State Ill
SECTION Corner common to sections 13, 24, 18 and 19

EXISTING SURVEYS

Original Government Survey

Year surveyed _____

Original monument _____
(Wood post, stone, pile of stones, pipe, etc.)

Bearing Trees

Species _____

Diameter _____

Bearing _____

Distance _____

Original Evidence Found

Year of search _____ By _____

Monument found _____

Original Bearing Trees Found

Species _____

Diameter _____

Bearing _____

Distance _____

Subsequent Corner Restoration

Year surveyed 1962 By U.S. F.S.

Where filed or recorded _____

Monument 6" x 5" concrete w/ brass cap
(Original, concrete post, iron rod, etc.)

Evidence of Subsequent Corner Restoration, Found

Year of search 1-21-80 By JIM SCHOONOVER

Monument AND BTs IN GOODCondition. Signpost 4.88' NE ofMonument.

Bearing Trees, Reference Objects

Species Cedar Ash Elm spruce steel postDiameter 10" 6" 5" 6" 6"Bearing N57E S34E S41W N51W NorthDistance 131.8' 95.1' 44.1' 95.4' 4.88'

Bearing Trees, Reference Objects

Species CEDAR Ash Elm USPICKDiameter 14" 7" 6" 13"Bearing N57°E S34°E S41°W N51°WDistance 131.8' 95.1' 44.1' 95.4'

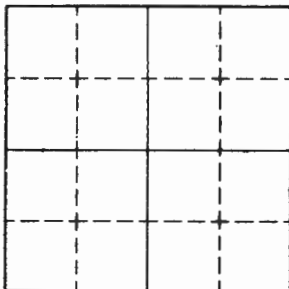

Sketch

Corner F.S. Land

Relation of Evidence to Record Features Along Section Lines

Section line to sections _____
Object _____
Record distance _____
Measured distance _____

Other Evidence

Describe evidence of use and occupation such as roads, fences, clearings, timber cutting lines, plantations, etc.. Cite source of testimony if any. _____

At time of search:

1. Did you have the record description?

Yes _____ No _____

2. How was search area located?

Pacing, chaining, photos, maps,
etc. _____

3. Man hours spent in search _____

4. Do you think additional search might
recover evidence? Yes _____ No _____

5. Signature _____

Perpetuation Record

Monument and accessories established. Include brief description of area. _____

Certified corner restoration certificate prepared: Yes _____ No _____

Filed in county records at _____ Date _____ County Document No. _____

Identified on aerial photo No. _____ Which is filed at _____

T. 148 R. 20 Mer. N.F. Chippewa County Itasca State Minnesota
Section Corner common to sections 16, 17, 21 and 20

EXISTING SURVEYS

Original Government Survey

Year surveyed 1875 - Benjamin C. Baldwin
Original monument Wood Post
(Wood post, stone, pile of stones, pipe, etc.)

Bearing Trees

Species	<u>Aspen</u>	<u>Aspen</u>	<u>TAM.</u>	<u>ASPEN</u>
Diameter	<u>6"</u>	<u>10"</u>	<u>6"</u>	<u>8"</u>
Bearing	<u>N 40° W</u>	<u>S 52° W</u>	<u>S 30° E</u>	<u>N 70° E</u>
Distance	<u>7 LKS</u>	<u>22 LKS</u>	<u>19 LKS</u>	<u>27 LKS</u>

Subsequent Corner Restoration

Year surveyed 1926 By County - L.W. Johnson
Where filed or recorded Itasca County Courthouse
Monument 3/4" I.P.
(Original, concrete post, iron rod, etc.)

Bearing Trees, Reference Objects

Species	<u>Basswood</u>	<u>Birch</u>	<u>Spruce</u>	<u>Ash</u>
Diameter	<u>10"</u>	<u>8"</u>	<u>4"</u>	<u>5"</u>
Bearing	<u>N 69° W</u>	<u>S 40° W</u>	<u>S 79° E</u>	<u>N 37° E</u>
Distance	<u>60.8</u>	<u>47.2</u>	<u>59.5</u>	<u>40.7</u>

Original Evidence Found

Year of search 1926 By Itasca County Surveyor
Monument found L.W. Johnson
Symbol on 1926 subdivision shows original
Corner found. Original Bearing Trees Found

Species	_____	_____	_____	_____
Diameter	_____	_____	_____	_____
Bearing	_____	_____	_____	_____
Distance	_____	_____	_____	_____

Evidence of Subsequent Corner Restoration Found

Year of search 1978 By Constock & Davis
Found 3/4" IP in place.
Found Basswood BT stump & Birch stump
at distances shown for ties.
Set 1" galvanized pipe 6' long w/plastic
cap RLS # 10832 18" above ground

Bearing Trees, Reference Objects

Species	<u>Ash</u>	<u>Ash</u>	<u>Ash</u>	<u>Ash</u>
Diameter	<u>10"</u>	<u>12"</u>	<u>6"</u>	<u>18"</u>
Bearing	<u>NNW</u>	<u>NE</u>	<u>ESE</u>	<u>SSW</u>
Distance	<u>24.85</u>	<u>11.03</u>	<u>17.15</u>	<u>14.26</u>

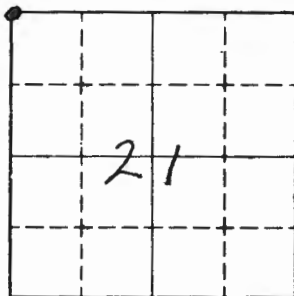

Sketch

○ Corner F.S. Land

Relation of Evidence to Record Features Along Section Lines

Section line to sections _____
 Object _____
 Record distance _____
 Measured distance _____

Other Evidence

Describe evidence of use and occupation such as roads, fences, clearings, timber cutting lines, plantations, etc.. Cite source of testimony if any. _____

*Itasca County - July 22, 1978 - Found 1" Gal. I.P.
 w/ plastic plug # 10832 driven deep in ground also
 3/4" H nearby 126 BTs
 Basswood 10" N69°W 60.8 - Found stump
 Birch 8" S40°W 47.2 - Found 10" fallen snag w/ scribe
 Ash 5" N37°E 40.7 - Found 12" x 14" very rotten stump
 Spruce 4" S79°E 59.5 - Found 6" w/ scribed face*

At time of search:

1. Did you have the record description?

Yes _____ No _____

2. How was search area located?

Pacing, chaining, photos, maps,
 etc. _____

3. Man hours spent in search _____

4. Do you think additional search might

recover evidence? Yes _____ No _____

5. Signature _____

Perpetuation Record

Monument and accessories established. Include brief description of area. _____

*1986 - K&O found same as above.
 1987 - K&O found again and brought BT's to GSKS Standard
 - monument was left as found -*

Certified corner restoration certificate prepared: Yes _____ No _____

Filed in county records at _____ Date _____ County Document No. _____

Identified on aerial photo No. _____ Which is filed at _____

Index No. N-11
(Alphabetical - Numerical)LAND CORNER RECORD
(RECTANGULAR SURVEYS)R9-7150-4 (Rev. 6/13/67)
GPO 802-127T. 148 R. 26 Mer. N.F. Chippewa County Itasca State Minnesota
1/4 Corner common to sections 16 and 21

EXISTING SURVEYS

Original Government Survey

Year surveyed 1875 - Benjamin C. Baldwin
Original monument Wood Post
(Wood post, stone, pile of stones, pipe, etc.)

Bearing Trees

Species Birch Birch
Diameter 8" 10"
Bearing S 7° W N 5° W
Distance 13 Lks 31 Lks

Subsequent Corner Restoration

Year surveyed 1989 By K. & O. Inc
Where filed or recorded Itasca County
Monument 2" x 54" Brass capped monument
(Original, concrete post, iron rod, etc.)

Bearing Trees, Reference Objects

Species MAPLE BASSWOOD SPRUCE STEEL SIGN STEEL SIGN
Diameter 4" 6" 5"
Bearing N 02° W S 83° E S 02° W SOUTH EAST
Distance 28.36 13.57 29.65 46 3.0

Original Evidence Found

Year of search 1986 By Kovanen & Olesen Inc
Monument found No evidence recovered

Original Bearing Trees Found

Species _____
Diameter _____
Bearing _____
Distance _____

Evidence of Subsequent Corner Restoration Found

Year of search _____ By _____

Bearing Trees, Reference Objects

Species _____
Diameter _____
Bearing _____
Distance _____

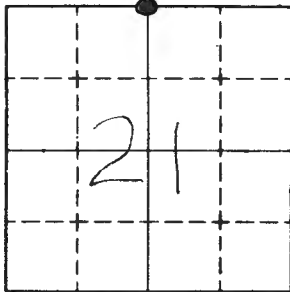

Sketch

○ Corner ▨ F.S. Land

Relation of Evidence to Record Features Along Section Lines

Section line to sections _____
 Object _____
 Record distance _____
 Measured distance _____

Other Evidence

Describe evidence of use and occupation such as roads, fences, clearings, timber cutting lines, plantations, etc.. Cite source of testimony if any. _____

At time of search:

1. Did you have the record description?

Yes _____ No _____

2. How was search area located?

Pacing, chaining, photos, maps, etc. _____

3. Man hours spent in search _____

4. Do you think additional search might

recover evidence? Yes _____ No _____

5. Signature _____

Perpetuation Record

Monument and accessories established. Include brief description of area. _____

Certified corner restoration certificate prepared: Yes _____ No _____

Filed in county records at _____ Date _____ County Document No. _____

Identified on aerial photo No. _____ Which is filed at _____

Index No. N-12,13
(Alphabetical - Numerical)

LAND CORNER RECORD
(RECTANGULAR SURVEYS)

RD-7150-4 (Rev. 6/13/67)
 GPO 802-127

T. 148 R. 26 Mer. N.F. Chippewa County Itasca State Minnesota
WC to SC-MC Corner common to sections 16, 21 and _____

EXISTING SURVEYS

Original Government Survey

Year surveyed _____
 Original monument _____
(Wood post, stone, pile of stones, pipe, etc.)

Bearing Trees

Species _____
 Diameter _____
 Bearing _____
 Distance _____

Subsequent Corner Restoration

Year surveyed 1989 By Kovanen & Osafson
 Where filed or recorded Itasca County
 Monument 2" x 54" Brass capped mon
(Original, concrete post, iron rod, etc.)

925.00' WEST OF NE COR SEC 21

Bearing Trees, Reference Objects

Species	<u>MAPLE</u>	<u>ASH</u>	<u>MAPLE</u>	<u>SIGN</u>
Diameter	<u>4"</u>	<u>14"</u>	<u>4"</u>	
Bearing	<u>N18°W</u>	<u>S68°E</u>	<u>N86°W</u>	<u>East</u>
Distance	<u>30.57</u>	<u>10.59</u>	<u>19.13</u>	<u>4'</u>

Original Evidence Found

Year of search _____ By _____
 Monument found _____

Original Bearing Trees Found

Species _____
 Diameter _____
 Bearing _____
 Distance _____

Evidence of Subsequent Corner Restoration Found

Year of search _____ By _____

Bearing Trees, Reference Objects

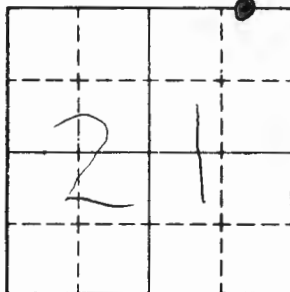

Sketch

Corner F.S. Land

Relation of Evidence to Record Features Along Section Lines

Section line to sections _____
 Object _____
 Record distance _____
 Measured distance _____

Other Evidence

Describe evidence of use and occupation such as roads, fences, clearings, timber cutting lines, plantations, etc.. Cite source of testimony if any. _____

At time of search:

1. Did you have the record description?

Yes _____ No _____

2. How was search area located?

Pacing, chaining, photos, maps, etc. _____

3. Mon hours spent in search _____

4. Do you think additional search might recover evidence? Yes _____ No _____

5. Signature _____

Perpetuation Record

Monument and accessories established. Include brief description of area. _____

Certified corner restoration certificate prepared: Yes _____ No _____

Filed in county records at _____ Date _____ County Document No. _____

Identified on aerial photo No. _____ Which is filed at _____

T. 148 R. 26 5th Mer. N.F. Chippewa County Itasca State Minnesota
Section 9 MC. Corner common to sections 15, 16, 21 and 22

EXISTING SURVEYS

Original Government Survey

Year surveyed 1875 - Benjamin C. Baldwin
 Original monument Wood post
(Wood post, stone pile of stones, pipe, etc.)

	Bearing Trees			
Species	<u>TAM</u>	<u>TAM</u>	<u>TAM</u>	<u>TAM</u>
Diameter	<u>8"</u>	<u>5"</u>	<u>4"</u>	<u>5"</u>
Bearing	<u>N 43° W</u>	<u>S 70° W</u>	<u>S 22° E</u>	<u>N 1° E</u>
Distance	<u>28 LKS</u>	<u>15 LKS</u>	<u>128 LKS</u>	<u>79 LKS</u>

Subsequent Corner Restoration

Year surveyed 1989 By K & O Inc.
 Where filed or recorded Itasca County
 Monument Witness monument set
(Original, concrete pipe, iron rod, etc.)
925 West of true position due to boggy nature of area

Bearing Trees, Reference Objects

Species	<u>MAPLE</u>	<u>MAPLE</u>	<u>ASH</u>	<u>STEEL SIGN</u>
Diameter	<u>4"</u>	<u>4"</u>	<u>14"</u>	
Bearing	<u>N 18° W</u>	<u>N 86° W</u>	<u>S 68° E</u>	<u>EAST</u>
Distance	<u>30.57</u>	<u>19.13</u>	<u>10.59</u>	<u>4.0</u>

Original Evidence Found

Year of search 1986 By K & O Inc
 Monument found No evidence of corner found

Original Bearing Trees Found

Species	_____	_____	_____	_____
Diameter	_____	_____	_____	_____
Bearing	_____	_____	_____	_____
Distance	_____	_____	_____	_____

Evidence of Subsequent Corner Restoration Found

Year of search _____ By _____

Bearing Trees, Reference Objects

Species	_____	_____	_____	_____
Diameter	_____	_____	_____	_____
Bearing	_____	_____	_____	_____
Distance	_____	_____	_____	_____

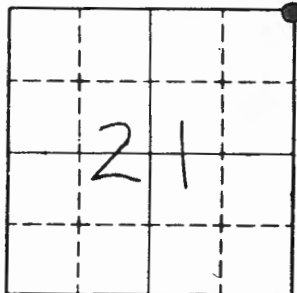

Sketch

○ Corner ▨ F.S. Land

Relation of Evidence to Record Features Along Section Lines

Section line to sections _____
 Object _____
 Record distance _____
 Measured distance _____

Other Evidence

Describe evidence of use and occupation such as roads, fences, clearings, timber cutting lines, plantations, etc.. Cite source of testimony if any. _____

At time of search:

1. Did you have the record description?

Yes _____ No _____

2. How was search area located?

Pacing, chaining, photos, maps, etc. _____

3. Man hours spent in search _____

4. Do you think additional search might recover evidence? Yes _____ No _____

5. Signature _____

Perpetuation Record

Monument and accessories established. Include brief description of area. _____

Certified corner restoration certificate prepared: Yes _____ No _____

Filed in county records at _____ Date _____ County Document No. _____

Identified on aerial photo No. _____ Which is filed at _____

T. 148 R. 26 S. 5 Mer. N.F. Chippewa County ITASCA State MN
W 16 Corner common to sections 14 23 and _____

EXISTING SURVEYS

County
Original Government Survey
Year surveyed 1919
Original monument Iron Pipe
(Wood post, stone, pile of stones, pipe, etc.)

Bearing Trees
Species RICH BIRCH
Diameter 9" 8"
Bearing S36°E N78°W
Distance 30.8' 28.5'

Subsequent Corner Restoration
Year surveyed 1962 By R.H. McDonald
Where filed or recorded _____
Monument Iron Pipe with Brass Cap
(Original, concrete post, etc. red, etc.)

Bearing Trees, Reference Objects
Species BIRCH WSPRUCE
Diameter 6" 5"
Bearing N72°E N78°W
Distance 30.35' 91.4'

Original Evidence Found
Year of search 12-6-62 By R.H. McDonald
Monument found 1" Iron Pipe

Original Bearing Trees Found
Species BIRCH
Diameter DECAYED
Bearing S29°E
Distance 30.8'

Evidence of Subsequent Corner Restoration Found
Year of search 1979 By JL
Found BRASS CAP
SCRIBE VISIBLE

Bearing Trees, Reference Objects
BIRCH WSPRUCE
Stump 13"
N72°E N78°W
30.35' 91.4'

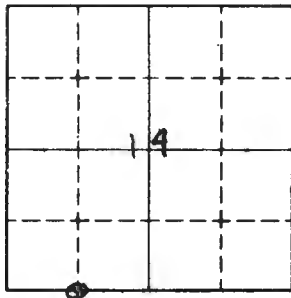

Sketch

○ Corner ▨ F.S. Land

Relation of Evidence to Record Features Along Section Lines

Section line to sections _____
 Object _____
 Record distance _____
 Measured distance _____

Other Evidence

Describe evidence of use and occupation such as roads, fences, clearings, timber cutting lines, plantations, etc.. Cite source of testimony if any. _____

NEEDS Two BT'S

At time of search:

1. Did you have the record description?

Yes No _____

2. How was search area located?

Pacing, chaining, photos, maps, etc. MAPS

3. Man hours spent in search _____

4. Do you think additional search might recover evidence? Yes _____ No

5. Signature [Signature]

Perpetuation Record

Monument and accessories established. Include brief description of area. _____

PLACED STEEL POST 28' East of Monument.

Certified corner restoration certificate prepared: Yes _____ No _____

Filed in county records at _____ Date _____ County Document No. _____

Identified on aerial photo No. _____ Which is filed at _____

Index No. N-23
(Alphabetical - Numerical)

LAND CORNER RECORD
(RECTANGULAR SURVEYS)

RD-7150-4 (Rev. 6/13/67)
 GPO 802-127

T. 148 N. R. 26 W. 5th Mer. N.F. Chippewa County Itasca State Mn
1/4 Corner common to sections 13 and 24

EXISTING SURVEYS

Original Government Survey

Year surveyed _____

Original monument _____
(Wood post, stone, pile of stones, pipe, etc.)

Bearing Trees

Species _____

Diameter _____

Bearing _____

Distance _____

Original Evidence Found

Year of search _____ By _____

Monument found no evidence found

Original Bearing Trees Found

Species _____

Diameter _____

Bearing _____

Distance _____

Subsequent Corner Restoration

Year surveyed 1984 By USFS

Where filed or recorded Itasca County Court House

Monument Set a 5 ft. long by 2 1/2 in O.D. concrete
(Original, concrete post, iron rod, etc.)
filled galvanized iron pipe, brass cap stand;
un 1/2 5 ft. All BT's & posts
painted red

Evidence of Subsequent Corner Restoration Found

Year of search _____ By _____

Bearing Trees, Reference Objects

Species	<u>Aspen</u>	<u>Aspen</u>	<u>Aspen</u>	<u>2 metal fence posts</u>
Diameter	<u>7.8"</u>	<u>5.7"</u>	<u>10.3"</u>	<u>1 south</u>
Bearing	<u>N28°E</u>	<u>S55°E</u>	<u>N28°W</u>	<u>1 west</u>
Distance	<u>49.34'</u>	<u>24.77'</u>	<u>29.63'</u>	<u>3.0'</u>

5° declination

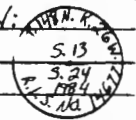

Bearing Trees, Reference Objects

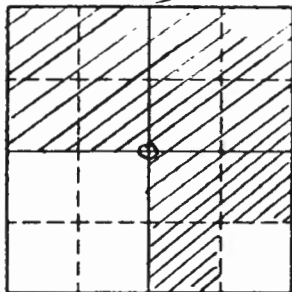

24
Sketch

○ Corner ▨ F.S. Land

Relation of Evidence to Record Features Along Section Lines

Section line to sections _____
 Object _____
 Record distance _____
 Measured distance _____

Other Evidence

Describe evidence of use and occupation such as roads, fences, clearings, timber cutting lines, plantations, etc.. Cite source of testimony if any. Red line runs West from corner. Corner can be reached by an old road coming down through the center of the section from the highway

At time of search:

1. Did you have the record description?

Yes _____ No _____

2. How was search area located?

Pacing, chaining, photos, maps, etc. _____

3. Man hours spent in search _____

4. Do you think additional search might recover evidence? Yes _____ No _____

5. Signature _____

Perpetuation Record

Monument and accessories established. Include brief description of area. _____

Certified corner restoration certificate prepared: Yes _____ No _____

Filed in county records of _____ Date _____ County Document No. _____

Identified on aerial photo No. _____ Which is filed at _____

T. 148 N R. 26 W 5th Mer. N.F. Chippewa County MINN State
Sec corner Corner common to sections 13, 24 and _____

EXISTING SURVEYS

Original Government Survey

Year surveyed _____
 Original monument wood post
(Wood post, stone, pile of stones, pipe, etc.)

Bearing Trees			
Species	<u>Tam</u>	<u>Tam</u>	<u>Tam</u>
Diameter	<u>4"</u>	<u>4"</u>	<u>4"</u>
Bearing	<u>N55°E</u>	<u>S75°E</u>	<u>S30°W</u>
Distance	<u>23.10'</u>	<u>20.00'</u>	<u>40.00'</u>

Subsequent Corner Restoration

Year surveyed 1961 By USFS
 Where filed or recorded _____
 Monument 5.145.18
(Original, concrete post, iron rod, etc.)

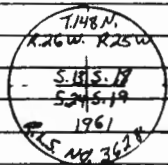

Bearing Trees, Reference Objects

Species	<u>Tam</u>	<u>Tam</u>	<u>Tam</u>	<u>Tam</u>
Diameter	<u>6"</u>	<u>8"</u>	<u>6"</u>	<u>5"</u>
Bearing	<u>S16 1/2°E</u>	<u>N40 1/2°E</u>	<u>S62°W</u>	<u>N80°W</u>
Distance	<u>32.3'</u>	<u>33.2'</u>	<u>23.3'</u>	<u>22.4'</u>

Original Evidence Found

Year of search 1934 By Tam Stake
 Monument found Found 2 Gant BT's & a 1920 BT

Original-Bearing Trees Found Established

Species	<u>Tam</u>	<u>Tam</u>	<u>Tam</u>
Diameter	<u>4"</u>	<u>8"</u>	<u>4"</u>
Bearing	<u>N58°W</u>	<u>N87°E</u>	<u>S45°E</u>
Distance	<u>16.50'</u>	<u>56.10'</u>	<u>29.70'</u>

Evidence of Subsequent Corner Restoration Found

Year of search March 1984 By USFS recovered monument, up 18". Found 1920 BT (stamp), 3 1934 BT's (2 stamps), and all 4 1961 BT's. All BT's & posts painted red.

Bearing Trees, Reference Objects

1934 Tam	1961 Tam	1961 Tam	1961 Tam
<u>5.8"</u>	<u>9.0"</u>	<u>6.2"</u>	<u>6.0"</u>
<u>N59°W</u>	<u>N35°E</u>	<u>S17°E</u>	<u>S50°W</u>
<u>17.08'</u>	<u>31.13'</u>	<u>32.38'</u>	<u>23.16'</u>

co. Jackson

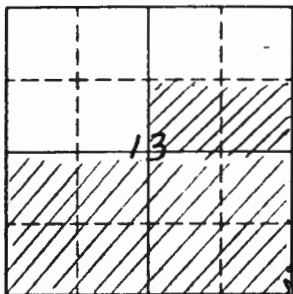

Sketch

○ Corner ▨ F.S. Land

Relation of Evidence to Record Features Along Section Lines

Section line to sections _____
 Object _____
 Record distance _____
 Measured distance _____

Other Evidence

Describe evidence of use and occupation such as roads, fences, clearings, timber cutting lines, plantations, etc., Cite source of testimony if any. *Corner is a brass cap*
BT is a 6" Tamarack corner lies S 80° E 22 ft BT is a 6"
Tamarack corner lies N 52° E 23 ft BT is 6" Tamarack
corner lies N 16° W 28 ft BT is on 8" Tamarack
corner lies S 40° W 33 ft Blue line painted N +
is a cut out line Red line goes N + E from
corner

At time of search:

1. Did you have the record description?
 Yes _____ No _____

2. How was search area located?
 Pacing, chaining, photos, maps,
 etc. _____

3. Man hours spent in search _____

4. Do you think additional search might
 recover evidence? Yes _____ No _____

Perpetuation Record

Monument and accessories established. Include brief description of area. *Marsh, 1984*
USFS recovered a 2 1/2" O.D. galvanized iron pipe, Brass cap stamped:

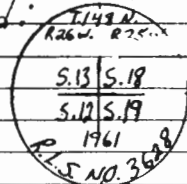

Certified corner restoration certificate prepared: Yes _____ No _____

Filed in county records at _____ Date _____ County Document No. _____

Identified on aerial photo No. _____ Which is filed at _____

5. Signature *7-29-73 SMM*

Index No. 01P-5
(Alphabetical - Numerical)

BOOK # 3
PAGE # 1

LAND CORNER RECORD
(RECTANGULAR SURVEYS)

R9-7150-4 (Rev. 6/13/67)
GPO 802-127

T. 148 R. 26 Mer. N.F. Chippewa County ITASCA State MN.
MC. North Bet. Corner common to sections 19, 20, and _____

EXISTING SURVEYS

Original Government Survey

Year surveyed 1875 Nov.-Dec.
Original monument Wood post
(Wood post, stone, pile of stones, pipe, etc.)

Bearing Trees

Species Ash Oak
Diameter 4 7
Bearing N43E S20W
Distance 1851ks. 2781ks.
122.1 183.5'

Subsequent Corner Restoration

Year surveyed _____ By _____
Where filed or recorded _____
Monument? _____
(Original, concrete post, iron rod, etc.)

Bearing Trees, Reference Objects

Species _____
Diameter _____
Bearing _____
Distance _____

Original Evidence Found

Year of search _____ By _____
Monument found _____

Original Bearing Trees Found

Species _____
Diameter _____
Bearing _____
Distance _____

Evidence of Subsequent Corner Restoration Found

Year of search _____ By _____

Bearing Trees, Reference Objects

Species _____
Diameter _____
Bearing _____
Distance _____

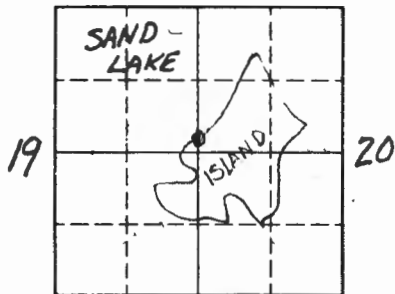

Sketch

○ Corner ▨ F.S. Land

Relation of Evidence to Record Features Along Section Lines

Section line to sections _____
 Object _____
 Record distance _____
 Measured distance _____

Other Evidence

Describe evidence of use and occupation such as roads, fences, clearings, timber cutting lines, plantations, etc.. Cite source of testimony if any. _____

At time of search:

1. Did you have the record description?

Yes _____ No _____

2. How was search area located?

Pacing, chaining, photos, maps, etc. _____

3. Man hours spent in search _____

4. Do you think additional search might recover evidence? Yes _____ No _____

5. Signature _____

Perpetuation Record

Monument and accessories established. Include brief description of area. _____

Certified corner restoration certificate prepared: Yes _____ No _____

Filed in county records at _____ Date _____ County Document No. _____

Identified on aerial photo No. _____ Which is filed at _____

Index No. O.P.-13
(Alphabetical - Numerical)LAND CORNER RECORD
(RECTANGULAR SURVEYS)R9-7150-4 (Rev. 6/13/67)
GPO 802-127T. 148 R. 26 5th Mer. N.F. Chippewa County Itasca State Minnesota
POB on line Corner common to sections 21, 22 and _____

EXISTING SURVEYS

Original Government Survey

Year surveyed _____
Original monument _____
(Wood post, stone, pile of stones, pipe, etc.)

Bearing Trees

Species _____
Diameter _____
Bearing _____
Distance _____

Subsequent Corner Restoration

Year surveyed. 1989 By KOUAUN E OSURSEN
Where filed or recorded ITASCA COUNTY
Monument 2" x 54" Brass capped man
(Original, concrete post, iron rod, etc.)

Bearing Trees, Reference Objects

Species B of G B of G MAPLE SIGN
Diameter 10" 9" 6"
Bearing S50°W S13°W S17°E SOUTH
Distance 15.70' 27.62' 53.90' 4.5'

Original Evidence Found

Year of search _____ By _____
Monument found _____

Original Bearing Trees Found

Species _____
Diameter _____
Bearing _____
Distance _____

Evidence of Subsequent Corner Restoration Found

Year of search _____ By _____

Bearing Trees, Reference Objects

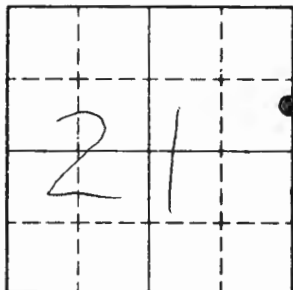

Sketch

○ Corner ▨ F.S. Land

Relation of Evidence to Record Features Along Section Lines

Section line to sections _____
 Object _____
 Record distance _____
 Measured distance _____

Other Evidence

Describe evidence of use and occupation such as roads, fences, clearings, timber cutting lines, plantations, etc.. Cite source of testimony if any. _____

At time of search:

1. Did you have the record description?

Yes _____ No _____

2. How was search area located?

Pacing, chaining, photos, maps, etc. _____

3. Man hours spent in search _____

4. Do you think additional search might recover evidence? Yes _____ No _____

5. Signature _____

Perpetuation Record

Monument and accessories established. Include brief description of area. _____

Certified corner restoration certificate prepared: Yes _____ No _____

Filed in county records at _____ Date _____ County Document No. _____

Identified on aerial photo No. _____ Which is filed at _____

T. 148 N R. 26 W Mer. N.F. Chippewa County Itasca State Minnesota
14 Corner common to sections 19 & 24

EXISTING SURVEYS

Original Government Survey	Original Evidence Found
Year surveyed _____	Year of search _____ By _____
Original monument _____ <small>(Wood post, stone, pile of stones, pipe, etc.)</small>	Monument found _____
Bearing Trees	Original Bearing Trees Found
Species _____	Species _____
Diameter _____	Diameter _____
Bearing _____	Bearing _____
Distance _____	Distance _____
Subsequent Corner Restoration	Evidence of Subsequent Corner Restoration Found
Year surveyed <u>1962</u> By <u>U.S.F.S.</u>	Year of search <u>1990</u> By <u>R. Olson</u>
Where filed or recorded _____	Where filed or recorded _____
Monument <u>2" x 5" iron w/ brass cap.</u> <small>(Original, concrete post, iron rod, etc.)</small>	<u>2" Iron w/ brass cap in place</u>
Bearing Trees, Reference Objects	Bearing Trees, Reference Objects
Species <u>Elm Elm</u> <u>Steel post</u>	<u>Elm Elm Steel post</u>
Diameter <u>8" 8" 6"</u>	<u>9" 10" 6"</u>
Bearing <u>N54W S51E South</u>	<u>N59W S51E West</u>
Distance <u>35.0' 36.1' 4.82'</u>	<u>35.0' 36.1' 2.0'</u>

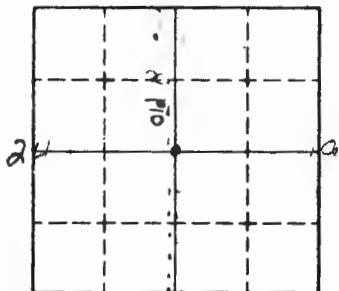

Sketch

○ Corner ▨ F.S. Land

Relation of Evidence to Record Features Along Section Lines

Section line to sections _____
 Object _____
 Record distance _____
 Measured distance _____

Other Evidence

Describe evidence of use and occupation such as roads, fences, clearings, timber cutting lines, plantations, etc.. Cite source of testimony if any. _____

At time of search:

1. Did you have the record description?

Yes _____ No _____

2. How was search area located?

Pacing, chaining, photos, maps, etc. _____

3. Man hours spent in search _____

4. Do you think additional search might recover evidence? Yes _____ No _____

5. Signature _____

Perpetuation Record

Monument and accessories established. Include brief description of area. _____

To perpetuate this Cor I cut New BT.

Maple Steel post
 6" 8"
 N34E South
 36.15' 2.2'
 1/4 S19
 BT 54-2

5/22/80
 Ronald O'Brien

Certified corner restoration certificate prepared: Yes _____ No _____
 Filled in county records at _____ Date _____ County Document No. _____
 Identified on aerial photo No. _____ Which is filed at _____

Index No. P-9.10
(Alphabetical - Numerical)

LAND CORNER RECORD
(RECTANGULAR SURVEYS)

RD-7150-4 (Rev. 6/13/67)
GPO 802-127

T. 148 R. 26 5th Mer. N.F. Chippewa County Itasca State Minnesota
W.C. Corner common to sections 21 and _____

EXISTING SURVEYS

Original Government Survey

Year surveyed _____
Original monument _____
(Wood post, stone, pile of stones, pipe, etc.)

Bearing Trees

Species _____
Diameter _____
Bearing _____
Distance _____

Original Evidence Found

Year of search _____ By _____
Monument found _____

Original Bearing Trees Found

Species _____
Diameter _____
Bearing _____
Distance _____

Subsequent Corner Restoration

Year surveyed. 1989 By KOUANEN & OSGREN
Where filed or recorded Itasca County
Monument 2" x 54" Brass capped man
(Original, concrete post, iron rod, etc.)

Evidence of Subsequent Corner Restoration Found

Year of search _____ By _____

Bearing Trees, Reference Objects

Species	<u>MAPLE</u>	<u>BIRCH</u>	<u>BIRCH</u>	<u>SIGN</u>
Diameter	<u>6"</u>	<u>5"</u>	<u>6"</u>	
Bearing	<u>N24°E</u>	<u>S80°E</u>	<u>S56°E</u>	<u>East</u>
Distance	<u>30.31</u>	<u>4.3</u>	<u>11.82</u>	<u>3.2</u>

Bearing Trees, Reference Objects

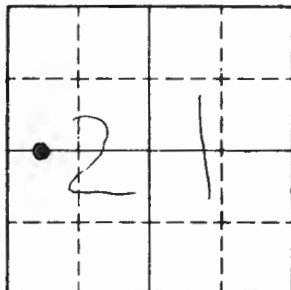

Sketch

○ Corner ▨ F.S. Land

Relation of Evidence to Record Features Along Section Lines

Section line to sections _____
 Object _____
 Record distance _____
 Measured distance _____

Other Evidence

Describe evidence of use and occupation such as roads, fences, clearings, timber cutting lines, plantations, etc.. Cite source of testimony if any. _____

At time of search:

1. Did you have the record description?

Yes _____ No _____

2. How was search area located?

Pacing, chaining, photos, maps, etc. _____

3. Man hours spent in search _____

4. Do you think additional search might recover evidence? Yes _____ No _____

5. Signature _____

Perpetuation Record

Monument and accessories established. Include brief description of area. _____

Certified corner restoration certificate prepared: Yes _____ No _____

Filed in county records of _____ Date _____ County Document No. _____

Identified on aerial photo No. _____ Which is filed at _____

Index No. P-11
(Alphabetical - Numerical)

LAND CORNER RECORD
(RECTANGULAR SURVEYS)

RG-7150-4 (Rev. 6/13/67)
GPO 802-127

T. 148 R. 26 5th Mer. N.F. Chippewa County Itasca State Minnesota
CENTER 1/4 Corner common to sections 21 and _____

EXISTING SURVEYS

Original Government Survey

Year surveyed _____
Original monument _____
(Wood post, stone, pile of stones, pipe, etc.)

Bearing Trees

Species _____
Diameter _____
Bearing _____
Distance _____

Original Evidence Found

Year of search _____ By _____
Monument found _____

Original Bearing Trees Found

Species _____
Diameter _____
Bearing _____
Distance _____

Subsequent Corner Restoration

Year surveyed 1987 By KOUENEN & OSUSEN
Where filed or recorded ITASCA COUNTY
Monument 2" X 54" BRASS CAPPED MON.
(Original, concrete post, iron rod, etc.)

Evidence of Subsequent Corner Restoration Found

Year of search _____ By _____

Bearing Trees, Reference Objects

Species	<u>BASSWOOD</u>	<u>MAPLE</u>	<u>BASSWOOD</u>	<u>SIGN</u>
Diameter	<u>5"</u>	<u>9"</u>	<u>8"</u>	
Bearing	<u>N40°W</u>	<u>S40°W</u>	<u>S63°E</u>	<u>NORTH</u>
Distance	<u>19.13</u>	<u>4.74</u>	<u>23.45</u>	<u>80'</u>

Bearing Trees, Reference Objects

<u>SIGN</u>	<u>SIGN</u>	<u>SIGN</u>
<u>SOUTH</u>	<u>EAST</u>	<u>WEST</u>
<u>5.6'</u>	<u>5.8'</u>	<u>6.9'</u>

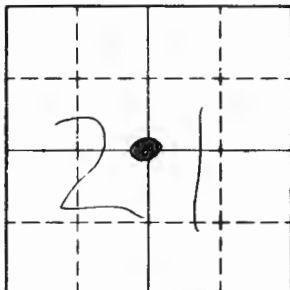

Sketch

Corner F.S. Land

Relation of Evidence to Record Features Along Section Lines

Section line to sections _____
 Object _____
 Record distance _____
 Measured distance _____

Other Evidence

Describe evidence of use and occupation such as roads, fences, clearings, timber cutting lines, plantations, etc.. Cite source of testimony if any. _____

At time of search:

1. Did you have the record description?

Yes _____ No _____

2. How was search area located?

Pacing, chaining, photos, maps, etc. _____

3. Man hours spent in search _____

4. Do you think additional search might recover evidence? Yes _____ No _____

5. Signature _____

Perpetuation Record

Monument and accessories established. Include brief description of area. _____

Certified corner restoration certificate prepared: Yes _____ No _____

Filed in county records of _____ Date _____ County Document No. _____

Identified on aerial photo No. _____ Which is filed at _____

T. 148 R. 26 Mer. N.F. Chippewa County Itasca State Minnesota
1/4 E.M.C. Corner common to sections 21 and 22

EXISTING SURVEYS

Original Government Survey

Year surveyed 1875 - Benjamin C. Baldwin
Original monument Not stated in original notes
(Wood post, stone, pile of stones, pipe, etc.)

Bearing Trees

Species Aspen Tam.
Diameter 12" 6"
Bearing N22°W N46°E
Distance 20 Lks 22 Lks
13.20 14.52'

Subsequent Corner Restoration

Year surveyed 1989 By K & O Surveyors
Where filed or recorded Itasca Co.
Monument 2" x .54" Brass capped mon
(Original, concrete post, iron rod, etc.)

Bearing Trees, Reference Objects

Species BASSWOOD BIRCH ASH STEEL SIGN STEEL SIGN
Diameter 7" 7" 10"
Bearing N53°W N32°E S90°W WEST NORTH
Distance 39.30 39.35 32.30 3.6 4.0

Original Evidence Found

Year of search 1962 By R. N. McDonald USFS
Monument found No evidence of original corner found

Original Bearing Trees Found

Species 1986 K & O Surveyors traverse to approx
Diameter position and make search but no evidence
Bearing of corner was recovered
Distance

Evidence of Subsequent Corner Restoration Found

Year of search _____ By _____

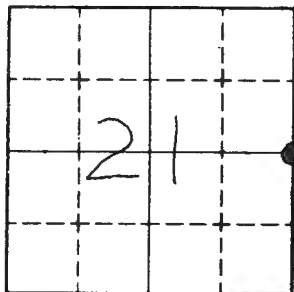

Sketch

○ Corner ▨ F.S. Land

Relation of Evidence to Record Features Along Section Lines

Section line to sections _____
 Object _____
 Record distance _____
 Measured distance _____

Other Evidence

Describe evidence of use and occupation such as roads, fences, clearings, timber cutting lines, plantations, etc.. Cite source of testimony if any. _____

At time of search:

1. Did you have the record description?
 Yes _____ No _____

2. How was search area located?
 Pacing, chaining, photos, maps,
 etc. _____

3. Man hours spent in search _____

4. Do you think additional search might
 recover evidence? Yes _____ No _____

5. Signature _____

Perpetuation Record

Monument and accessories established. Include brief description of area. _____

Certified corner restoration certificate prepared: Yes _____ No _____
 Filed in county records at _____ Date _____ County Document No. _____
 Identified on aerial photo No. _____ Which is filed at _____

Index No. P-21
(Alphabetical - Numerical)

Book #2
Page # 17

LAND CORNER RECORD
(RECTANGULAR SURVEYS)

R9-7150-4 (Rev. 6/13/67) S.O.
GPO 802-127

T. 148 N, 26 W
1/4

Mer. N.F. Chippewa County Itasca State Minnesota
Corner common to sections 23 & 24 and _____

EXISTING SURVEYS

Original Government Survey

Year surveyed _____
Original monument _____
(Wood post, stone, pile of stones, pipe, etc.)

Bearing Trees

Species _____
Diameter _____
Bearing _____
Distance _____

Subsequent Corner Restoration

Year surveyed 1963 By Okerman
Where filed or recorded _____
Monument 2" Iron pipe w/ Brass cap
(Original, concrete post, wood rod, etc.)

Bearing Trees, Reference Objects

Species Tam Tam
Diameter 5" 6"
Bearing N16E N28W
Distance 132.0' 108.5'

Original Evidence Found

Year of search _____ By _____
Monument found _____

Original Bearing Trees Found

Species _____
Diameter _____
Bearing _____
Distance _____

Evidence of Subsequent Corner Restoration Found

Year of search 1980 By P. Olesen
found Iron in place

Bearing Trees, Reference Objects

Species Tam Tam
Diameter 5" 6"
Bearing N16E N28W
Distance 132.0' 108.5'

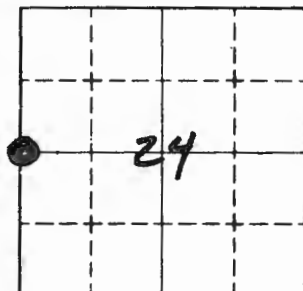

Sketch

○ Corner ▨ F.S. Land

Relation of Evidence to Record Features Along Section Lines

Section line to sections _____
 Object _____
 Record distance _____
 Measured distance _____

Other Evidence

Describe evidence of use and occupation such as roads, fences, clearings, timber cutting lines, plantations, etc.. Cite source of testimony if any. _____

At time of search:

1. Did you have the record description?

Yes _____ No _____

2. How was search area located?

Pacing, chaining, photos, maps, etc. _____

3. Man hours spent in search _____

4. Do you think additional search might recover evidence? Yes _____ No _____

5. Signature _____

Perpetuation Record

Monument and accessories established. Include brief description of area.

To perpetuate this cor I cut 1 new BT from which

*7' x 7' 8" steel
 4" with sign
 NB/E South
 38.4" E. 10"*

*Line posted to standard south
 1/2 mile*

1/4 sec BT

Certified corner restoration certificate prepared: Yes _____ No _____
 Filed in county records at _____ Date _____ County Document No. _____
 Identified on aerial photo No. _____ Which is filed at _____

T. T148N. R. 26E. S. 5E Mer. N.F. Chippewa County Itasca State Minnesota
South 1/16 Corner common to sections 19 & 24

EXISTING SURVEYS

Original Government Survey

Year surveyed _____
 Original monument _____
(Wood post, stone, pile of stones, pipe, etc.)

Bearing Trees

Species _____
 Diameter _____
 Bearing _____
 Distance _____

Subsequent Corner Restoration

Year surveyed 1962 By U.S. F.S.
 Where filed or recorded _____
 Monument 6" x 5" cylinder w/ Brass caps
(Original, concrete post, wood, etc.)

Original Evidence Found

Year of search _____ By _____
 Monument found _____

Original Bearing Trees Found

Species _____
 Diameter _____
 Bearing _____
 Distance _____

Evidence of Subsequent Corner Restoration Found

Year of search 1980 By Ron Dlosen
 Monument in place

Species	County	Bearing Trees, Reference Objects	Steel Post
Cedar	Cedar	Cedar	Post
Diameter	12"	9"	8"
Bearing	S22W	N21E-W	S36E North
Distance	17.4'	42.15	31.25 5.18

Species	County	Bearing Trees, Reference Objects	Steel post
Cedar	Cedar	Cedar	Steel post
Diameter	15"	11"	10"
Bearing	S22W	N21E-W	S36E North
Distance	17.4'	42.15	31.25 5.18

Relation of Evidence to Record Features Along Section Lines

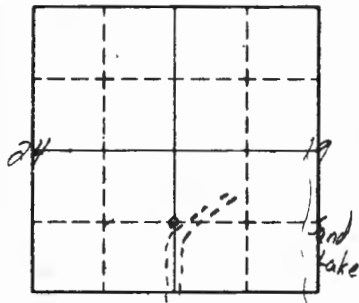

Sketch

○ Corner ▨ F.S. Land

Section line to sections _____
 Object _____
 Record distance _____
 Measured distance _____

Other Evidence

Describe evidence of use and occupation such as roads, fences, clearings, timber cutting lines, plantations, etc.. Cite source of testimony if any. _____

Give to Standard North & South of Cor.

At time of search:

1. Did you have the record description?

Yes _____ No _____

2. How was search area located?

Pacing, chaining, photos, maps, etc. _____

3. Man hours spent in search _____

4. Do you think additional search might recover evidence? Yes _____ No _____

5. Signature _____

Perpetuation Record

Monument and accessories established. Include brief description of area. _____

*set 8' steel post South 2.8'
 w/size 54-2*

*5/22/80
 Ronald D. Olson*

Certified corner restoration certificate prepared: Yes _____ No _____

Filed in county records at _____ Date _____ County Document No. _____

Identified on aerial photo No. _____ Which is filed at _____

Index No. Q-12
(Alphabetical - Numerical)

LAND CORNER RECORD
(RECTANGULAR SURVEYS)

RD-7150-4 (Rev. 6/13/67)
 GPO 802-127

T. 148 R. 26 Mer. 5th N.F. Chippewa County Itasca State Minnesota
SE 1/4 Corner common to sections 21 and _____

EXISTING SURVEYS

Original Government Survey

Year surveyed _____
 Original monument _____
(Wood post, stone, pile of stones, pipe, etc.)

Bearing Trees

Species _____
 Diameter _____
 Bearing _____
 Distance _____

Subsequent Corner Restoration

Year surveyed 1989 By Kouanen OSUFSEN
 Where filed or recorded Itasca County
 Monument 2" X 5/4" Brass capped man
(Original, concrete post, iron rod, etc.)

Bearing Trees, Reference Objects

Species	<u>W PINE</u>	<u>Basswood</u>	<u>MAPLE</u>	<u>Sign</u>
Diameter	<u>2 1/2"</u>	<u>10"</u>	<u>5"</u>	
Bearing	<u>N70°W</u>	<u>N12°W</u>	<u>N72°E</u>	<u>West</u>
Distance	<u>31.38</u>	<u>17.40</u>	<u>12.89</u>	<u>5.7</u>

Original Evidence Found

Year of search _____ By _____
 Monument found _____

Original Bearing Trees Found

Species _____
 Diameter _____
 Bearing _____
 Distance _____

Evidence of Subsequent Corner Restoration Found

Year of search _____ By _____

Bearing Trees, Reference Objects

Species	_____	_____	_____	_____
Diameter	_____	_____	_____	_____
Bearing	_____	_____	_____	_____
Distance	_____	_____	_____	_____

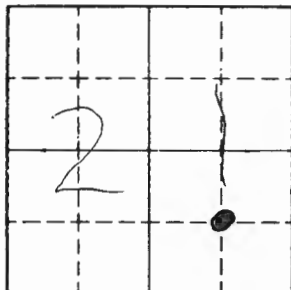

Sketch

○ Corner ▨ F.S. Land

Relation of Evidence to Record Features Along Section Lines

Section line to sections _____
 Object _____
 Record distance _____
 Measured distance _____

Other Evidence

Describe evidence of use and occupation such as roads, fences, clearings, timber cutting lines, plantations, etc.. Cite source of testimony if any. _____

At time of search:

1. Did you have the record description?

Yes _____ No _____

2. How was search area located?

Pacing, chaining, photos, maps,
 etc. _____

3. Man hours spent in search _____

4. Do you think additional search might

recover evidence? Yes _____ No _____

5. Signature _____

Perpetuation Record

Monument and accessories established. Include brief description of area. _____

Certified corner restoration certificate prepared: Yes _____ No _____

Filed in county records at _____ Date _____ County Document No. _____

Identified on aerial photo No. _____ Which is filed at _____

T. 148 R. 26 Sth Mer. N.F. Chippewa County Itasca State Minnesota
MC Corner common to sections 21 and 22

EXISTING SURVEYS

Original Government Survey	
Year surveyed	<u>1875 - Benjamin C. Baldwin</u>
Original monument	<u>Not stated in original notes</u> <small>(Wood post, stone, pile of stones, pipe, etc.)</small>
Bearing Trees	
Species	<u>ELM ASPEN</u>
Diameter	<u>8" 5"</u>
Bearing	<u>S44°E S7°W</u>
Distance	<u>69 Lks 49 Lks</u>

Original Evidence Found	
Year of search	<u>1981</u> By <u>USFS, Olson & Whitehorn</u>
Monument found	<u>1" pipe at edge of lake - called it possible M.C.</u>
Original Bearing Trees Found	
Species	<u>1986 - K & O Inc - made search and</u>
Diameter	<u>found no evidence of corner</u>
Bearing	
Distance	

Subsequent Corner Restoration	
Year surveyed	<u>1987</u> By <u>K & O Inc</u>
Where filed or recorded	
Monument	<u>1/2" Iron pipe</u> <small>(Original, concrete post, iron rod, etc.)</small>

Evidence of Subsequent Corner Restoration Found	
Year of ^{Survey} search	<u>1989</u> By <u>K & O Surveyors</u>
<u>reestablish true position and set WC</u>	
<u>2" x 54" Brass capped man</u>	
<u>58.06' South of MC</u>	

Bearing Trees, Reference Objects	
Species	
Diameter	
Bearing	
Distance	

Bearing Trees, Reference Objects			
<u>Spruce</u>	<u>Ash</u>	<u>Balsam</u>	<u>STEEL SIGN</u>
<u>12"</u>	<u>12"</u>	<u>7"</u>	
<u>N77°W</u>	<u>N66°E</u>	<u>S27°W</u>	<u>SOUTH</u>
<u>20.92</u>	<u>14.50</u>	<u>44.54</u>	<u>4.5'</u>

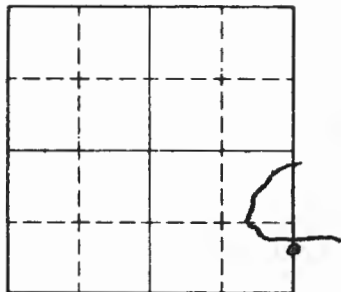

Sketch

○ Corner ▨ F.S. Land

Relation of Evidence to Record Features Along Section Lines

Section line to sections _____
 Object _____
 Record distance _____
 Measured distance _____

Other Evidence

Describe evidence of use and occupation such as roads, fences, clearings, timber cutting lines, plantations, etc.. Cite source of testimony if any. _____

At time of search:

1. Did you have the record description?

Yes _____ No _____

2. How was search area located?

Pacing, chaining, photos, maps,
 etc. _____

3. Man hours spent in search _____

4. Do you think additional search might
 recover evidence? Yes _____ No _____

5. Signature _____

Perpetuation Record

Monument and accessories established. Include brief description of area. _____

Certified corner restoration certificate prepared: Yes _____ No _____

Filed in county records at _____ Date _____ County Document No. _____

Identified on aerial photo No. _____ Which is filed at _____

Index No. R-1
(Alphabetical - Numerical)

*Book # 2
Page # 3*

LAND CORNER RECORD
(RECTANGULAR SURVEYS)

RP-7150-4 (Rev. 5/13/67) 5.0.
GPO 502-127

T. 148 R. 26-27 Mer. N.F. Chippewa County Itasca State Minnesota
5th
300 Corner common to sections 19, 24, 25 and 30

EXISTING SURVEYS

Original Government Survey

Year surveyed _____
Original monument _____
(Wood post, stone, pile of stones, pipe, etc.)

Bearing Trees

Species _____
Diameter _____
Bearing _____
Distance _____

Original Evidence Found

Year of search _____ By _____
Monument found _____

Original Bearing Trees Found

Species _____
Diameter _____
Bearing _____
Distance _____
*5/22/80
Annals/Chippewa*

Subsequent Corner Restoration

Year surveyed 1963 By U.S. F.S.
Where filed or recorded _____
Monument 6" x 24" Concrete Cylinder w/
brass cap.
(Original, concrete post, iron rod, etc.)

Evidence of Subsequent Corner Restoration Found

Year of search 1980 By R. C. Olson
6" Concrete Cylinder on roof
597 MISSISSIPPI

Bearing Trees, Reference Objects

Species	<u>Cedar</u>	Cedar	Cedar	County <u>Redga</u>
Diameter	<u>9"</u>	10"	5"	<u>9"</u>
Bearing	<u>N27W</u>	S62E	S57W	<u>N44E</u>
Distance	<u>100.7'</u>	58.9'	33.7'	<u>43.0'</u>

Bearing Trees, Reference Objects

Species	<u>Cedar</u>	<u>Cedar</u>	County <u>Cedar</u>
Diameter	<u>10"</u>	<u>8"</u>	<u>9"</u>
Bearing	<u>N27W</u>	<u>S57W</u>	<u>N44E</u>
Distance	<u>100.7'</u>	<u>33.7'</u>	<u>43.0'</u>

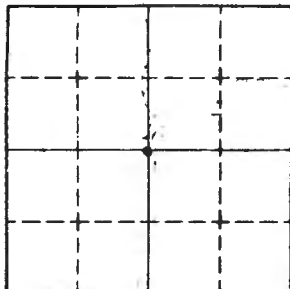

Sketch

○ Corner ▨ F.S. Land

Relation of Evidence to Record Features Along Section Lines

Section line to sections _____
 Object _____
 Record distance _____
 Measured distance _____

Other Evidence

Describe evidence of use and occupation such as roads, fences, clearings, timber cutting lines, plantations, etc.. Cite source of testimony if any. _____

At time of search:

1. Did you have the record description?

Yes _____ No _____

2. How was search area located?

Pacing, chaining, photos, maps, etc. _____

3. Man hours spent in search _____

4. Do you think additional search might recover evidence? Yes _____ No _____

5. Signature _____

Perpetuation Record

Monument and accessories established. Include brief description of area. _____

Certified corner restoration certificate prepared: Yes _____ No _____

Filed in county records at _____ Date _____ County Document No. _____

Identified on aerial photo No. _____ Which is filed at _____

T. 148 R. 26 5th Mer. N.F. Chippewa County Itasca State Minnesota
MC Corner common to sections 21 and 28

EXISTING SURVEYS

Original Government Survey

Year surveyed 1875 - Benjamin C. Baldwin
Original monument 3" Balsam tree (marked)
(Wood post, stone, pile of stones, pipe, etc.)

Bearing Trees

Species Birch W Pine
Diameter 9" 12"
Bearing N23°E S22°E
Distance 18 Lks 35 Lks

Subsequent Corner Restoration

Year surveyed _____ By _____
Where filed or recorded _____
Monument _____
(Original, concrete post, iron rod, etc.)

Bearing Trees, Reference Objects

Species _____
Diameter _____
Bearing _____
Distance _____

Original Evidence Found

Year of search 1934 By Herbert Norman USFS
Monument found None but set 1 1/2" x 1 1/2" x 2"
temporary Aspen stake.

Original Bearing Trees Found

Species W Pine
Diameter 18"
Bearing S17°W W17°S
Distance 26 Lks

Evidence of Subsequent Corner Restoration Found

Year of search 1986 By K & O Inc
Original white pine was fd but no other
evidence located
1989 - K & O Inc - Original position
established but not set - A WLC was set
2" x 54" brass-capped man.

Bearing Trees, Reference Objects

Bearing Trees, Reference Objects			
<u>MAPLE</u>	<u>MAPLE</u>	<u>OAK</u>	<u>STEEL SIGN</u>
<u>4"</u>	<u>4"</u>	<u>7"</u>	
<u>N22°E</u>	<u>N77°E</u>	<u>S67°E</u>	<u>PAST</u>
<u>14.16'</u>	<u>36.68'</u>	<u>11.65'</u>	<u>3.6'</u>

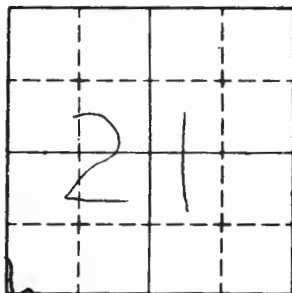

Sketch

○ Corner ▨ F.S. Land

Relation of Evidence to Record Features Along Section Lines

Section line to sections _____
 Object _____
 Record distance _____
 Measured distance _____

Other Evidence

Describe evidence of use and occupation such as roads, fences, clearings, timber cutting lines, plantations, etc.. Cite source of testimony if any. _____

At time of search:

1. Did you have the record description?

Yes _____ No _____

2. How was search area located?

Pacing, chaining, photos, maps, etc. _____

3. Man hours spent in search _____

4. Do you think additional search might

recover evidence? Yes _____ No _____

5. Signature _____

Perpetuation Record

Monument and accessories established. Include brief description of area. _____

Certified corner restoration certificate prepared: Yes _____ No _____

Filed in county records at _____ Date _____ County Document No. _____

Identified on aerial photo No. _____ Which is filed at _____

T. 148 R. 26 5th Mer. N.F. Chippewa County Itasca State Minnesota
Y4 Corner common to sections 21 and 28

EXISTING SURVEYS

Original Government Survey

Year surveyed 1875 - Benjamin C. Baldwin
Original monument Wood post
(Wood post, stone, pile of stones, pipe, etc.)

Bearing Trees

Species Aspen Aspen
Diameter 6" 6"
Bearing N89°W S87°W
Distance 5.00 ch. 5.15 ch.
33' 339.9'

Subsequent Corner Restoration

Year surveyed 1989 By Kouanen Osufson Inc.
Where filed or recorded Itasca County Courthouse
Monument 20' Aluminum rod monument
(Original, concrete post, iron rod, etc.)

Bearing Trees, Reference Objects

Species ASH STEEL SIGN STEEL SIGN
Diameter 5"
Bearing N88°W WEST NORTH
Distance 401.98 2.55 3.1

Original Evidence Found

Year of search 1986 By K & O. Inc
Monument found None

Original Bearing Trees Found

Species _____
Diameter _____
Bearing _____
Distance _____

Evidence of Subsequent Corner Restoration Found

Year of search _____ By _____

Bearing Trees, Reference Objects

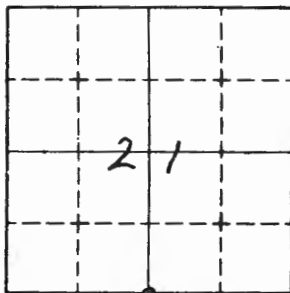

Sketch

○ Corner ▨ F.S. Land

Relation of Evidence to Record Features Along Section Lines

Section line to sections _____
 Object _____
 Record distance _____
 Measured distance _____

Other Evidence

Describe evidence of use and occupation such as roads, fences, clearings, timber cutting lines, plantations, etc.. Cite source of testimony if any. _____

At time of search:

1. Did you have the record description?

Yes _____ No _____

2. How was search area located?

Pacing, chaining, photos, maps, etc. _____

3. Man hours spent in search _____

4. Do you think additional search might recover evidence? Yes _____ No _____

5. Signature _____

Perpetuation Record

Monument and accessories established. Include brief description of area. _____

Certified corner restoration certificate prepared: Yes _____ No _____

Filed in county records at _____ Date _____ County Document No. _____

Identified on aerial photo. No. _____ Which is filed at _____

Index No. R-12
(Alphabetical - Numerical)

LAND CORNER RECORD
(RECTANGULAR SURVEYS)

R9-7150-4 (Rev. 6/13/67)
GPO 802-127

T. 148 R. 26 Sth Mer. N.F. Chippewa County Itasca State Minnesota
E 1/4 Corner common to sections 21, 28, and _____

EXISTING SURVEYS

Original Government Survey	
Year surveyed _____	
Original monument _____ <small>(Wood post, stone, pile of stones, pipe, etc.)</small>	
Bearing Trees	
Species _____	
Diameter _____	
Bearing _____	
Distance _____	

Original Evidence Found	
Year of search _____	By _____
Monument found _____	
Original Bearing Trees Found	
Species _____	
Diameter _____	
Bearing _____	
Distance _____	

Subsequent Corner Restoration	
Year surveyed. <u>1989</u>	By <u>KOUENEN OSUFSSEN</u>
Where filed or recorded <u>Itasca County</u>	
Monument <u>2" x 54" Brass capped iron</u> <small>(Original, concrete post, wax red, etc.)</small>	

Evidence of Subsequent Corner Restoration Found	
Year of search _____	By _____

Bearing Trees, Reference Objects				
Species	<u>ASH</u>	<u>ASH</u>	<u>ASH</u>	<u>SIGN</u>
Diameter	<u>8"</u>	<u>7"</u>	<u>7"</u>	
Bearing	<u>N65°W</u>	<u>N17°E</u>	<u>S55°E</u>	<u>EAST</u>
Distance	<u>5.34</u>	<u>21.74</u>	<u>18.43</u>	<u>3.6</u>

Bearing Trees, Reference Objects	

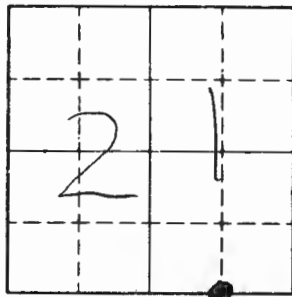

Sketch

○ Corner ▨ F.S. Land

Relation of Evidence to Record Features Along Section Lines

Section line to sections _____
 Object _____
 Record distance _____
 Measured distance _____

Other Evidence

Describe evidence of use and occupation such as roads, fences, clearings, timber cutting lines, plantations, etc.. Cite source of testimony if any. _____

At time of search:

1. Did you have the record description?

Yes _____ No _____

2. How was search area located?

Pacing, chaining, photos, maps, etc. _____

3. Mon hours spent in search _____

4. Do you think additional search might recover evidence? Yes _____ No _____

5. Signature _____

Perpetuation Record

Monument and accessories established. Include brief description of area. _____

Certified corner restoration certificate prepared: Yes _____ No _____

Filed in county records at _____ Date _____ County Document No. _____

Identified on aerial photo No. _____ Which is filed at _____

Index No. R-13
(Alphabetical - Numerical)

LAND CORNER RECORD
(RECTANGULAR SURVEYS)

RD-7150-4 (Rev. 6/13/41)
GPO 502-1'

T. 148 N R. 26 W 5th P. Mer. N.F. Chippewa County Itasca State Minnesota
Section Corner common to sections 21, 22, 27 and 28

EXISTING SURVEYS

Original Government Survey

Year surveyed Nov-Dec 1875, B. C. Baldwin
Original monument "post"
(Wood post, stone, pile of stones, pipe, etc.)

Bearing Trees

Species	<u>Aspen</u>	<u>Aspen</u>	<u>Oak</u>	<u>Aspen</u>
Diameter	<u>5"</u>	<u>12"</u>	<u>9"</u>	<u>12"</u>
Bearing	<u>S 30° W</u>	<u>N 30° E</u>	<u>N 27° W</u>	<u>S 70° E</u>
Distance	<u>25 lks</u> <u>16.5'</u>	<u>7 lks</u> <u>4.6'</u>	<u>7 lks</u> <u>4.6'</u>	<u>3 lks</u> <u>2</u>

Subsequent Corner Restoration

Year surveyed _____ By _____
Where filed or recorded _____
Monument _____
(Original, concrete post, iron rod, etc.)

Bearing Trees, Reference Objects

Species	_____
Diameter	_____
Bearing	_____
Distance	_____

Original Evidence Found

Year of search Sept 1981 By K. Whitehorn, R. Olson
Monument found none

Original Bearing Trees Found

Species	<u>W. Oak</u>
Diameter	<u>18.5"</u>
Bearing	<u>N 27° W</u>
Distance	<u>4.62'</u>

Evidence of Subsequent Corner Restoration Found

Year of search _____ By _____

Bearing Trees, Reference Objects

Species	_____
Diameter	_____
Bearing	_____
Distance	_____

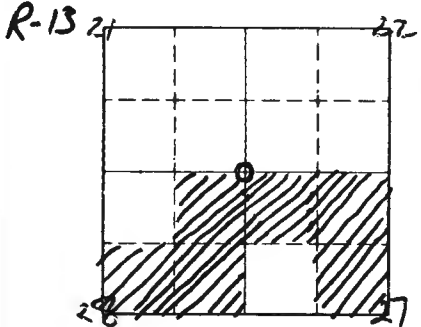

Sketch

O Corner ▨ F.S. Land

Relation of Evidence to Record Features Along Section Lines

Section line to sections	<u>21-22</u>	<u>21-22</u>	<u>21-22</u>	<u>22-27</u>
Object	<u>Swamp</u>	<u>4.5 chs Swamp</u>	<u>Lake</u>	<u>swamp</u>
Record distance	<u>33 chs (2178')</u>	<u>4.5 chs (297')</u>	<u>18.24 chs (1210')</u>	<u>3 chs (198')</u>
Measured distance	<u>2320'</u>	<u>300'</u>	<u>1170'</u>	<u>185'</u>

Other Evidence

Describe evidence of use and occupation such as roads, fences, clearings, timber cutting lines, plantations, etc.. Cite source of testimony if any.

See field book 1 T148N R26W Page 2
See corner Monumentation Book T148N, R26W Page 3
~~8" W. Oak N09°E 65.19'~~

At time of search:

1. Did you have the record description?

Yes X No _____

2. How was search area located?

Pacing, chaining, photos, maps, etc. chaining

3. Man hours spent in search 3

4. Do you think additional search might recover evidence? Yes _____ No X

5. Signature [Signature]

Perpetuation Record

Monument and accessories established. Include brief description of area. set 2"x5'

galv IP with 2 1/2" brass cap stamped: T.148N. R.26W.

<u>18.5" W. Oak N27°W</u>	<u>4.62' (original)</u>	<u>5.21</u>	<u>5.22</u>
<u>5" W. Oak N80°W</u>	<u>51.32'</u>	<u>5.28</u>	<u>5.27</u>
<u>11" W. Spruce S45°W</u>	<u>70.05'</u>	<u>1981</u>	
<u>4" W. Oak S23°E</u>	<u>41.77'</u>	<u>RLS 14677</u>	
<u>8" W. Oak N09°E</u>	<u>65.19'</u>		

Certified corner restoration certificate prepared: Yes _____ No _____

Filed in county records at _____ Date _____ County Document No. _____

Identified on aerial photo No. _____ Which is filed at _____

LAND CORNER RECORD
(RECTANGULAR SURVEYS)

Index No. R-19
(Alphabetical - Numerical)

148 N R. 26 W 5th Mer. N.F. Chippewa County Itasca State MINN.
Quarter Corner common to sections 23, 26 and

EXISTING SURVEYS

Original Government Survey

Year surveyed _____
Original monument _____
(Wood post, stone, pile of stones, pipe, etc.)

Bearing Trees

Species _____
Diameter _____
Bearing _____
Distance _____

Subsequent Corner Restoration

Year surveyed 1963 By W.M. Ockerman
Where filed or recorded Cut Foot R.S.
Monument 2" dia. steel pipe with a
(Original, concrete post, iron rod, etc.)
brass cap stamped: - T148N R26W
1/4 S23
1/4 S26
1963

Bearing Trees, Reference Objects

Species	<u>Elm</u>	<u>Elm</u>	<u>Elm</u>	<u>Steel Post</u>
Diameter	<u>17"</u>	<u>19"</u>	<u>8"</u>	<u>72" long</u>
Bearing	<u>N21°E</u>	<u>N27°W</u>	<u>S60°W</u>	<u>South</u>
Distance	<u>29.9'</u>	<u>38.9'</u>	<u>54.5'</u>	<u>4.15'</u>

Original Evidence Found

Year of search _____ By _____
Monument found _____

Original Bearing Trees Found

Species _____
Diameter _____
Bearing _____
Distance _____

Evidence of Subsequent Corner Restoration Found

Year of search Aug 21, 1985 By G. Robertson + B. Avick
Recovered a 2" dia. iron pipe with
a 2 1/2" dia. brass cap stamped:
Up 1.5 ft From which:
Steel sign post, East, 3.0'
" " South, 4.15'
1963 Elm (dead), 18.7" N23°E, 30.2'
New Maple 1963 Elm (dead) 1963 Elm (dead) New B. of E.
6.2" 9.6" 19.6" 7.4"
S52°W S62°W N33°W N66°W
51.55' 54.45' 38.97' 16.87'

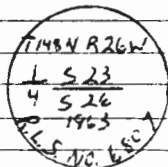

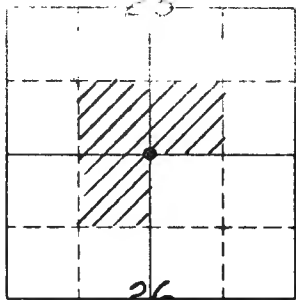

26
Sketch

○ Corner ▨ F.S. Land

Section line to sections _____
 Object _____
 Record distance _____
 Measured distance _____

Other Evidence

Describe evidence of use and occupation such as roads, fences, clearings, timber cutting lines, plantations, etc.. Cite source of testimony if any. *Red line runs East from this corner*

At time of search:

1. Did you have the record description?

Yes _____ No _____

2. How was search area located?

Pacing, chaining, photos, maps, etc.

3. Man hours spent in search _____

4. Do you think additional search might recover evidence? Yes _____ No _____

Perpetuation Record

Monument and accessories established. Include brief description of area.

Certified corner restoration certificate prepared: Yes No _____
 Filed in county records at *Grand Rapids* Date _____ County Document No. _____
 Identified on aerial photo No. _____ Which is filed at _____

5. Signature *A. McDonald*

T. 143 N R. 26 W Mer. 5th N.F. Chippewa County Wisconsin State Mn
E1116 Corner common to sections 23 and 26

EXISTING SURVEYS

Original Government Survey

Year surveyed _____

Original monument N/A
(Wood post, stone, pile of stones, pipe, etc.)

Bearing Trees

Species _____

Diameter _____

Bearing _____

Distance _____

Original Evidence Found

Year of search _____ By _____

Monument found _____

Original Bearing Trees Found

Species _____

Diameter _____

Bearing _____

Distance _____

Subsequent Corner Restoration

Year surveyed 8-23-85 By G. Kaszako & G. Robertson

Where filed or recorded _____

Monument Set a 2 1/2" dia. aluminum
(Original, concrete post, iron tag, etc.)
pipe with a 3/4" aluminum cap
stamped as shown, 1.0 ft below
cd. surface. Magnet at base of Mon.

Bearing Trees, Reference Objects

Species W. Birch W. Spruce AshDiameter 7.6" 16.6" 4.6"Bearing N44°E S75°E N77°WDistance 79.25' 63.32' 41.16'

Evidence of Subsequent Corner Restoration Found

Year of search _____ By _____

Bearing Trees, Reference Objects

Species _____

Diameter _____

Bearing _____

Distance _____

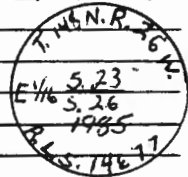

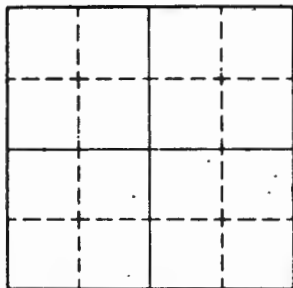

Sketch

Corner F.S. Land

Relation of Evidence to Record Features Along Section Lines

Section line to sections _____
Object _____
Record distance _____
Measured distance _____

Other Evidence

Describe evidence of use and occupation such as roads, fences, clearings, timber cutting lines, plantations, etc.. Cite source of testimony if any. _____

At time of search:

Did you have the record description?

Yes _____ No _____

How was search area located?

Pacing, chaining, photos, maps, etc. _____

Man hours spent in search _____

Do you think additional search might

recover evidence? Yes _____ No _____

Perpetuation Record

Monument and accessories established. Include brief description of area. _____

Certified corner restoration certificate prepared: Yes _____ No _____

Filed in county records at _____ Date _____ County Document No. _____

Identified on aerial photo No. _____ Which is F.S. # _____

Signature _____

T. 148 N R. 26 W S. TH Mer. N.F. CHIPPewa County ITASCA State MINN.
SECTION Corner common to sections 23, 24, 25, 26 and

EXISTING SURVEYS

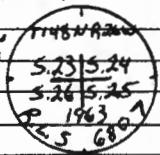
Original Government Survey				Original Evidence Found			
Year surveyed _____				Year of search _____ By _____			
Original monument _____ <small>(Wood post, stone, pile of stones, pipe, etc.)</small>				Monument found _____			
Bearing Trees				Original Bearing Trees Found			
Species _____	_____	_____	_____	Species _____	_____	_____	_____
Diameter _____	_____	_____	_____	Diameter _____	_____	_____	_____
Bearing _____	_____	_____	_____	Bearing _____	_____	_____	_____
Distance _____	_____	_____	_____	Distance _____	_____	_____	_____
Subsequent Corner Restoration				Evidence of Subsequent Corner Restoration Found			
Year surveyed <u>1963</u> By <u>WILLIAM H. OVERMAN</u>				Year of search <u>Aug 21, 1985</u> By <u>B. Ausk + G. Robertson</u>			
Where filed or recorded <u>CUT FOOT SIOUX R.S.</u>				Recovered a <u>6" cylindrical concrete</u>			
Monument <u>6" DIA. 72" LONG CYL. CONCRETE</u>				mon. with a <u>3 1/4" Brass cap stamped:</u>			
<u>Mon. W/ BRASS CAP STAMPED <u>TIAN R26W</u></u>							
<u>523 524</u>							
<u>526 525</u>							
Bearing Trees, Reference Objects				From which:			
Species <u>ASH</u>	<u>ELM</u>	<u>W. OAK</u>	<u>CEDAR POST</u>	<u>Ash</u>	<u>W. Oak</u>	<u>W. Oak</u>	<u>Ash</u>
Diameter <u>5"</u>	<u>11"</u>	<u>9"</u>	<u>4" x 4" x 72"</u>	<u>6.5"</u>	<u>13.4"</u>	<u>11.9"</u>	<u>5.6"</u>
Bearing <u>S 80 1/2° E</u>	<u>S 86° W</u>	<u>N 51 1/2° W</u>	<u>ONE WEST</u>	<u>S 77° E</u>	<u>N 50° W</u>	<u>N 11° E</u>	<u>S 77° W</u>
Distance <u>119.4'</u>	<u>154.2'</u>	<u>150.55'</u>	<u>2.48'</u>	<u>119.24'</u>	<u>150.45'</u>	<u>138.40'</u>	<u>133.97'</u>

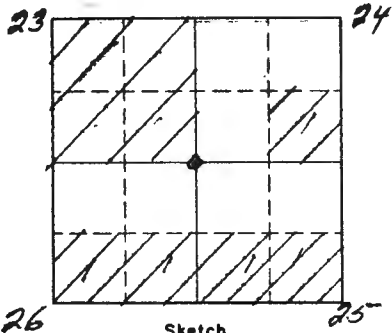

○ Corner ▨ F.S. Land

Relation of Evidence to Record Features Along Section Lines

Section line to sections _____
 Object _____
 Record distance _____
 Measured distance _____

Other Evidence

Describe evidence of use and occupation such as roads, fences, clearings, timber cutting lines, plantations, etc.. Cite source of testimony if any. This corner is in the middle of an old clearing

At time of search:

1. Did you have the record description?

Yes _____ No _____

2. How was search area located?

Pacing, chaining, photos, maps, etc. _____

3. How many hours spent in search _____

4. Do you think additional search might recover evidence? Yes _____ No _____

Perpetuation Record

Monument and accessories established. Include brief description of area. _____

Certified corner restoration certificate prepared: Yes No _____

Filed in county records at GRAND RAPIDS Date _____ County Document No _____

Identified on aerial photo No. _____ Which is filed at _____

5. Signature Donald E. Taylor

Relation of Evidence to Record Features Along Section Lines

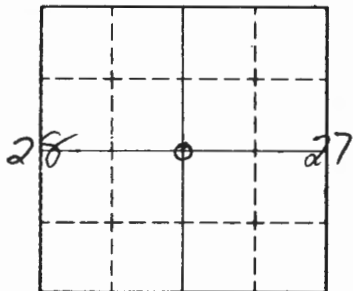

Sketch

○ Corner F.S. Lend

Section line to sections _____
 Object _____
 Record distance _____
 Measured distance _____

Other Evidence

Describe evidence of use and occupation such as roads, fences, clearings, timber cutting lines, plantations, etc.. Cite source of testimony if any.

12/19/62 Bob McDonald - searched 3 man hrs - 1 d. old, FS poster on 8" Cedar? small stake marking corner. poster not readable. About 100' South found FS poster which I had put up in 1951 by chaining North from sec. cor. 27th - 33rd - 74. No orig. evidence was found.

At time of search:

1. Did you have the record description?

Yes _____ No _____

2. How was search area located?

Pacing, chaining, photos, maps, etc. _____

3. Man hours spent in search _____

4. Do you think additional search might recover evidence? Yes _____ No _____

Signature _____

Perpetuation Record

Monument and accessories established. Include brief description of area. _____

Certified corner restoration certificate prepared: Yes _____ No _____
 Filed in county records at _____ Date _____ County Document No. _____
 Identified on aerial photo No. _____ Which is filed at _____

Index No. V-19
(Alphabetical - Numerical)

LAND CORNER RECORD
(RECTANGULAR SURVEYS)

RP-7150-4 (Rev. 6/13/67)
 GPO 802-127

T. 148 N. R. 26 W. 5th Mer. N.F. Chippewa County Hasca State Mn
4 Corner common to sections 26 and 35

EXISTING SURVEYS

Original Government Survey	Original Evidence Found
Year surveyed _____	Year of search _____ By _____
Original monument _____ <small>(Wood post, stone, pile of stones, pipe, etc.)</small>	Monument found _____
Bearing Trees	Original Bearing Trees Found
Species _____	Species _____
Diameter _____	Diameter _____
Bearing _____	Bearing _____
Distance _____	Distance _____
Subsequent Corner Restoration	Evidence of Subsequent Corner Restoration Found
Year surveyed. <u>11-8-62</u> By <u>McDonald</u>	Year of search _____ By _____
Where filed or recorded _____	_____
Monument <u>Set a 2" dia. by 5' long</u> <small>(Original, concrete post, iron rod, etc.)</small> <u>concrete filled galvanized iron</u> <u>pipe with a 3" dia brass cap</u> <u>stamped as shown</u>	_____
Bearing Trees, Reference Objects	Bearing Trees, Reference Objects
Species <u>W. Pine</u> <u>B. Ash</u> <u>B. Spruce</u> <u>B. Spruce</u>	<u>B. Ash</u> <u>Sign Post</u>
Diameter <u>12"</u> <u>10"</u> <u>8"</u> <u>5"</u>	<u>8"</u> <u>72" long</u>
Bearing <u>S7°W</u> <u>N72°W</u> <u>N18½°E</u> <u>S40°E</u>	<u>S61°W</u> <u>East</u>
Distance <u>20.6'</u> <u>21.0'</u> <u>26.5'</u> <u>11.6'</u>	<u>34.0'</u> <u>W/54-2454-4</u>

T148N. R. 26W
 L 5.26
 4 5.35
 P 1962
 S. No. 3628

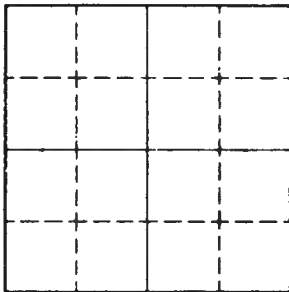

Sketch

○ Corner ▨ F.S. Land

Relation of Evidence to Record Features Along Section Lines

Section line to sections _____
Object _____
Record distance _____
Measured distance _____

Other Evidence

Describe evidence of use and occupation such as roads, fences, clearings, timber cutting lines, plantations, etc.. Cite source of testimony if any. _____

At time of search:

1. Did you have the record description?

Yes _____ No _____

2. How was search area located?

Pacing, chaining, photos, maps,
etc. _____

3. Man hours spent in search _____

4. Do you think additional search might
recover evidence? Yes _____ No _____

5. Signature _____

Perpetuation Record

Monument and accessories established. Include brief description of area. 12-12-85

G. Robertson, B. Ausk, & D. Ojinen

Found monument

1962 B. Spruce, 9.3" N17°E, 25.56'

1962 B. Spruce, 6.0" S39°E, 11.57'

1925 W. Pine, 16.2" S7°W, 20.30'

~~1962~~ B. Spruce, Ash, 10.7" N73°W, 20.96'

1962 B. Ash, 8.4" S61°W, 34.05'

BT's painted red

Certified corner restoration certificate prepared: Yes _____ No _____

Filed in county records at _____ Date _____ County Document No. _____

Identified on aerial photo No. _____ Which is filed at _____

Index No. V-21
(Alphabetical - Numerical)Book 4
PAGE 55LAND CORNER RECORD
(RECTANGULAR SURVEYS)

RD-7 150-4 (Rev. 6/13/67)

GPO 502-127

T. 148 R. 26 Mer. N.F. Chippewa County Itasca State MN
SEC. Corner common to sections 25, 26, 35 and 36

EXISTING SURVEYS

Original Government Survey

Year surveyed _____
Original monument _____
(Wood post, stone, pile of stones, pipe, etc.)

Bearing Trees

Species _____
Diameter _____
Bearing _____
Distance _____

Subsequent Corner Restoration

Year surveyed _____ By _____
Where filed or recorded _____
Monument _____
(Original, concrete post, iron rod, etc.)

Bearing Trees, Reference Objects

Species _____
Diameter _____
Bearing _____
Distance _____

Original Evidence Found

Year of search _____ By _____
Monument found _____

Original Bearing Trees Found

Species _____
Diameter _____
Bearing _____
Distance _____

Evidence of Subsequent Corner Restoration Found

Year of search 1-9-86 By USFS G. ROBERTSON
Found Monument broke B. AUSK
off, SET PK NAIL FROM old ptsFrom which: 1963 TREES

Bearing Trees, Reference Objects			
<u>W. Birch</u>	<u>J. Pine</u>	<u>J. Pine</u>	<u>Cedar</u>
<u>10.8"</u>	<u>13.9"</u>	<u>7.8"</u>	<u>4x4</u>
<u>N35°E</u>	<u>S46°E</u>	<u>S40°W</u>	<u>WEST</u>
<u>45.77</u>	<u>61.97</u>	<u>111.23</u>	<u>W/54-41</u>

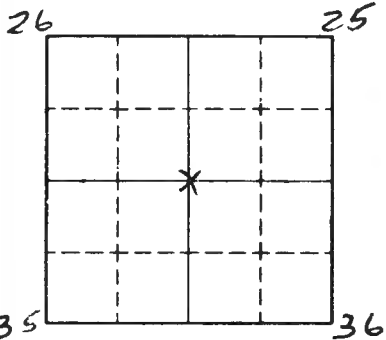

Sketch

○ Corner ▣ F.S. Land

Relation of Evidence to Record Features Along Section Lines

Section line to sections _____
 Object _____
 Record distance _____
 Measured distance _____

Other Evidence

Describe evidence of use and occupation such as roads, fences, clearings, timber cutting lines, plantations, etc.. Cite source of testimony if any. 1-9-86 USFS G. Robertson
Established: B. Husk
R. MAPLE 7.1" S31°E 89.02 to a 16d NAIL on
NE FACE DOUBLE BLAZED SCR" S36 BT" w/60d SPIKE
ASPEN 10.2" N39°W 83.28 to a 16d NAIL on
SW FACE DOUBLE BLAZE SCR" S26 BT" w/60d SPIKE

At time of search:

1. Did you have the record description?

Yes _____ No _____

2. How was search area located?

Pacing, chaining, photos, maps,
 etc. _____

3. Man hours spent in search _____

4. Do you think additional search might
 recover evidence? Yes _____ No _____

5. Signature _____

Perpetuation Record

Monument and accessories established. Include brief description of area. _____

Certified corner restoration certificate prepared: Yes _____ No _____

Filed in county records at _____ Date _____ County Document No. _____

Identified on aerial photo No. _____ Which is filed at _____

Index No. Y-21
(Alphabetical - Numerical)LAND CORNER RECORD
(RECTANGULAR SURVEYS)

R9-7 150-4 (Rev. 6/13/67)

GPO 802-127

T. 48N R. 26W 5th Mer. N.F. Chippewa County Itasca State Minnesota
Quarter Corner common to sections 35 and 36

EXISTING SURVEYS

Original Government Survey

Year surveyed _____
Original monument Post
(Wood post, stone, pile of stones, pipe, etc.)

Bearing Trees	
Species <u>Birch</u>	<u>Cedar</u>
Diameter <u>7"</u>	<u>5"</u>
Bearing <u>N86°W</u>	<u>S49°E</u>
Distance <u>6.60'</u>	<u>5.28'</u>

Subsequent Corner Restoration

Year surveyed 1925 By Itasca County
Where filed or recorded Itasca County Courthouse
Monument unknown
(Original, concrete post, iron rod, etc.)

Bearing Trees, Reference Objects	
Species <u>Birch</u>	<u>Cedar</u>
Diameter <u>12"</u>	<u>6"</u>
Bearing <u>N84°W</u>	<u>N38°E</u>
Distance <u>31.7'</u>	<u>40.0'</u>

Original Evidence Found

Year of search 1925 By Itasca County
Monument found not listed

Original Bearing Trees Found

Species Gov 4 Cedar
Diameter _____
Bearing _____
Distance _____

Evidence of Subsequent Corner Restoration Found

Year of search 1963 By USFS Okerman
End square scribed post w/ point
set 2" galvanized concrete filled iron
pipe, 5' long w/ 3" diameter brass
cap

Bearing Trees, Reference Objects			
<u>Birch</u>	<u>Cedar</u>	<u>Cedar</u>	<u>Cedar</u>
<u>stump</u>	<u>11"</u>	<u>8"</u>	<u>8"</u>
<u>N77°W</u>	<u>N45°E</u>	<u>S40°W</u>	<u>N54°E</u>
<u>31.7'</u>	<u>40.0'</u>	<u>16.4'</u>	<u>56.9'</u>

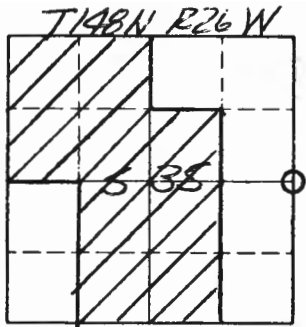

Sketch

○ Corner ▨ F.S. Land

Relation of Evidence to Record Features Along Section Lines

Section line to sections _____
 Object _____
 Record distance _____
 Measured distance _____

Other Evidence

Describe evidence of use and occupation such as roads, fences, clearings, timber cutting lines, plantations, etc.. Cite source of testimony if any. _____

At time of search:

1. Did you have the record description?

Yes No _____

2. How was search area located?

Pacing, chaining, photos, maps, etc. _____

3. Man hours spent in search 1/2

4. Do you think additional search might recover evidence? Yes _____ No

5. Signature Clara P. Kunkle

Perpetuation Record

Monument and accessories established. Include brief description of area. Nov 28, 1984

USFS Recovered a 2 1/2 inch. outside dia. galvanized iron pipe with a 3 inch brass cap stamped as shown. From which:
1963 Cedar, 11" N52°E, 57.18 ft.
1925 Cedar, 15.4" N45°E, 39.18 ft.
1963 Cedar, S 43°W, 17.10 ft.
Metal fence post, North, 4.0 ft w/54-2+54-4
Metal fence post, South, 3.0 ft w/54-2

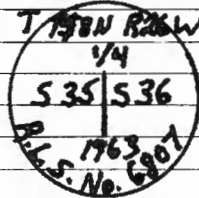

Certified corner restoration certificate prepared: Yes _____ No _____

Filed in county records at _____ Date _____ County Document No. _____

Identified on aerial photo No. _____ Which is filed at _____

Index No. 2-17
(Alphabetical - Numerical)

LAND CORNER RECORD
(RECTANGULAR SURVEYS)

T. 148-49 R. 261-2 5th Mer. N.F. Chippewa County Itasca State MINN
Sec 5 Corner common to sections 34, 35, 3 and 2

EXISTING SURVEYS

Original Government Survey

Year surveyed _____

Original monument _____
(Wood post, stone, pile of stone, pipe, etc.)

Bearing Trees

Species _____

Diameter _____

Bearing _____

Distance _____

Original Evidence Found

Year of search _____ By _____

Monument found _____

Original Bearing Trees Found

Species _____

Diameter _____

Bearing _____

Distance _____

Subsequent Corner Restoration

Year surveyed 1915 By Itasca Co.

Where filed or recorded _____

Monument _____
(Original, concrete post, iron rod, etc.)

Evidence of Subsequent Corner Restoration Found

Year of search 1963 By W.H. OKERMAN

Wood Post East 14.2'

Bearing Trees, Reference Objects

Species _____

Diameter _____

Bearing _____

Distance _____

<u>Rock</u>	<u>Rock</u>	<u>Rock</u>	<u>Rock</u>
<u>N14°E</u>	<u>2'x2'</u>	<u>4'x5'</u>	<u>1.5'x3.0'</u>
<u>45.9'</u>	<u>S88°W</u>	<u>56°E</u>	<u>N21°W</u>
	<u>43.1</u>	<u>91.2</u>	<u>132.0'</u>

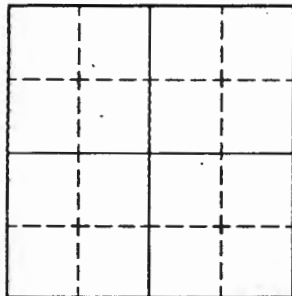

Sketch

Corner F.S. Land

Relation of Evidence to Record Features Along Section Lines

Section line to sections _____
Object _____
Record distance _____
Measured distance _____

Other Evidence

Describe evidence of use and occupation such as roads, fences, clearings, timber cutting lines, plantations, etc.. Cite source of testimony if any. Red line runs east from corner

At time of search:

Did you have the record description?

Yes _____ No _____

How was search area located?

Pacing, chaining, photos, maps, etc. _____

Man hours spent in search _____

Do you think additional search might recover evidence? Yes _____ No _____

Perpetuation Record

Monument and accessories established. Include brief description of area. 1985
G. Robertson & B. Ausk Pulled old man & set a 2' long by 2 1/2" dia. concrete filled galvanized iron pipe with a 3" dia. brass cap stop.
Below road surface 1.0" New BT's
Ash, 5.5" N15°E, 110.03'
Aspen, 13.2" S24°E, 71.77'
Aspen, 14.7" S57°W, 108.74'
1/2" rock, 1 1/2 x 3, N21°W, 132.05'

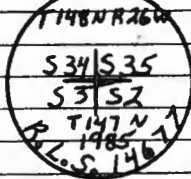

Certified corner restoration certificate prepared: Yes _____ No _____

Filed in county records at _____ Date _____ County Document No. _____

Index No. 2-18
(Alphabetical - Numerical)

LAND CORNER RECORD
(RECTANGULAR SURVEYS)

R9-7150-4 (Rev. 6/13/67)
 GPO 802-127

T. 148N R. 26W 5th Mer. N.F. Chippewa County Itasca State Mn
W1/16 Corner common to sections 35 and 2

EXISTING SURVEYS

Original Government Survey

Year surveyed _____
 Original monument _____
(Wood post, stone, pile of stones, pipe, etc.)

Bearing Trees

Species _____
 Diameter _____
 Bearing _____
 Distance _____

Original Evidence Found

Year of search _____ By _____
 Monument found _____

Original Bearing Trees Found

Species _____
 Diameter _____
 Bearing _____
 Distance _____

Subsequent Corner Restoration

Year surveyed 1985 By Bozack, Robertson, & Ausk
 Where filed or recorded Court House
 Monument Set a 5' long by 2 1/2" dia. concrete filled galvanized iron pipe with a 3" dia brass cap stop d: up 1.5"
(Original, concrete set, iron pipe, etc.)

Bearing Trees, Reference Objects

Species	<u>Aspen</u>	<u>Aspen</u>	<u>Aspen</u>	<u>2 fence posts</u>
Diameter	<u>1 1/4"</u>	<u>7/8"</u>	<u>9/8"</u>	<u>1 east</u>
Bearing	<u>S53°W</u>	<u>S87°W</u>	<u>North</u>	<u>1 west</u>
Distance	<u>7.39'</u>	<u>12.18'</u>	<u>1.71'</u>	<u>3.0'</u>

Evidence of Subsequent Corner Restoration Found

Year of search _____ By _____

Bearing Trees, Reference Objects

(Circular stamp)
 T148N R26W
 S. 35
 S. 2
 T147N
 1985
 S. 14677

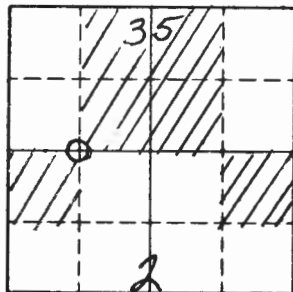

Sketch

○ Corner ▨ F.S. Land

Relation of Evidence to Record Features Along Section Lines

Section line to sections _____
 Object _____
 Record distance _____
 Measured distance _____

Other Evidence

Describe evidence of use and occupation such as roads, fences, clearings, timber cutting lines, plantations, etc.. Cite source of testimony if any. Red line runs east & west from corner

At time of search:

1. Did you have the record description?

Yes _____ No _____

2. How was search area located?

Pacing, chaining, photos, maps, etc. _____

3. Man hours spent in search _____

4. Do you think additional search might recover evidence? Yes _____ No _____

5. Signature _____

Perpetuation Record

Monument and accessories established. Include brief description of area. _____

Certified corner restoration certificate prepared: Yes _____ No _____

Filed in county records at _____ Date _____ County Document No. _____

Identified on aerial photo No. _____ Which is filed at _____

T. 148 N R. 26 W 5th Mer. N.F. Chippewa County Itasca State Mn
1/4 Corner common to sections 35 and 2

EXISTING SURVEYS

Original Government Survey

Year surveyed _____

Original monument _____
(Wood post, stone, pile of stones, pipe, etc.)

Bearing Trees

Species _____

Diameter _____

Bearing _____

Distance _____

Original Evidence Found

Year of search _____ By _____

Monument found _____

Original Bearing Trees Found

Species _____

Diameter _____

Bearing _____

Distance _____

Subsequent Corner Restoration

Year surveyed 1985 By G. Robertson & B. Aush

Where filed or recorded Court House

Monument Set a 5' long by 2 1/2" dia
(Original concrete post, iron rod, etc.)
concrete filled galvanized iron pipe
with a 3" dia brass cap stop.
Up 1.5'

Bearing Trees, Reference Objects

Species	<u>Birch</u>	<u>Aspen</u>	<u>Aspen</u>	<u>2 fence posts</u>
Diameter	<u>9.2"</u>	<u>7.6"</u>	<u>16.5"</u>	<u>1 East</u>
Bearing	<u>N76°E</u>	<u>S09°E</u>	<u>N42°W</u>	<u>1 West</u>
Distance	<u>45.04'</u>	<u>36.18'</u>	<u>24.79'</u>	<u>3.0'</u>

Evidence of Subsequent Corner Restoration Found

Year of search _____ By _____

Bearing Trees, Reference Objects

(Circular stamp)
 T. 148 N. R. 26 W.
 1/4 S. 35
 S. 2
 T. 147 N.
 R. 25
 S. 14671

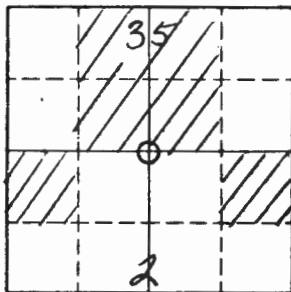

Sketch

○ Corner ▨ F.S. Land

Relation of Evidence to Record Features Along Section Lines

Section line to sections _____
 Object _____
 Record distance _____
 Measured distance _____

Other Evidence

Describe evidence of use and occupation such as roads, fences, clearings, timber cutting lines, plantations, etc.. Cite source of testimony if any. Red line runs East & West from corner

At time of search:

1. Did you have the record description?

Yes _____ No _____

2. How was search area located?

Pacing, chaining, photos, maps, etc. _____

3. Man hours spent in search _____

4. Do you think additional search might recover evidence? Yes _____ No _____

5. Signature _____

Perpetuation Record

Monument and accessories established. Include brief description of area. _____

Certified corner restoration certificate prepared: Yes _____ No _____

Filed in county records at _____ Date _____ County Document No. _____

Identified on aerial photo No. _____ Which is filed at _____

Index No. 7-20
(Alphabetical - Numerical)

LAND CORNER RECORD
(RECTANGULAR SURVEYS)

RD-7150-4 (Rev. 6/13/67)
 GPO 802-127

T. 148 N R. 26 W 5th Mer. N.F. Chippewa County Itasca State Mn
E1116 Corner common to sections 35 and 2

EXISTING SURVEYS

Original Government Survey

Year surveyed _____

Original monument _____
(Wood post, stone, pile of stones, pipe, etc.)

Bearing Trees

Species _____

Diameter _____

Bearing _____

Distance _____

Original Evidence Found

Year of search _____ By _____

Monument found _____

Original Bearing Trees Found

Species _____

Diameter _____

Bearing _____

Distance _____

Subsequent Corner Restoration

Year surveyed 1985 By Robertson & Ausk

Where filed or recorded Court House

Monument Set a 5" long by 2 1/2" dia.
(Original (concrete post, iron rod, etc.)
concrete filled galvanized iron
pipe with a 3" dia brass cap
Stamped: Up 1.5"

Bearing Trees, Reference Objects

Species	<u>Aspen</u>	<u>Pa Pine</u>	<u>W Birch</u>	<u>2 fence posts</u>
Diameter	<u>9.4"</u>	<u>16.0"</u>	<u>6.0"</u>	<u>1 east</u>
Bearing	<u>N 65° E</u>	<u>S 16° W</u>	<u>N 30° W</u>	<u>1 west</u>
Distance	<u>18.43'</u>	<u>36.68'</u>	<u>18.06'</u>	<u>3.0'</u>

Evidence of Subsequent Corner Restoration Found

Year of search _____ By _____

Bearing Trees, Reference Objects

(Circular stamp)
 T148 N. R26 W
 E1116 S35
 S2
 T147N
 1985
 S. 14671

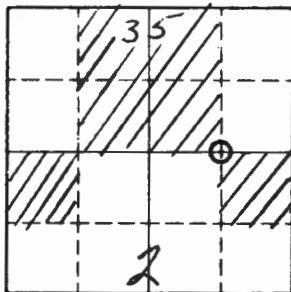

Sketch

○ Corner ▨ F.S. Land

Relation of Evidence to Record Features Along Section Lines

Section line to sections _____
 Object _____
 Record distance _____
 Measured distance _____

Other Evidence

Describe evidence of use and occupation such as roads, fences, clearings, timber cutting lines, plantations, etc. Cite source of testimony if any. *Red line runs east & west from corner*

At time of search:

1. Did you have the record description?

Yes _____ No _____

2. How was search area located?

Pacing, chaining, photos, maps, etc. _____

3. Man hours spent in search _____

4. Do you think additional search might recover evidence? Yes _____ No _____

5. Signature _____

Perpetuation Record

Monument and accessories established. Include brief description of area. _____

Certified corner restoration certificate prepared: Yes _____ No _____

Filed in county records at _____ Date _____ County Document No. _____

Identified on aerial photo No. _____ Which is filed at _____

Index No. Z-21
(Alphabetical - Numerical)

LAND CORNER RECORD
(RECTANGULAR SURVEYS)

RD-7150-4 (Rev. 6/13/67)
 GPO 502-127

T. 148 N. R. 26 W 5th Mer. N.F. Chippewa County Itasca State Mn
 Corner common to sections 35, 36, 1 and 2

EXISTING SURVEYS

Original Government Survey

Year surveyed _____
 Original monument _____
(Wood post, stone, pile of stones, pipe, etc.)

Bearing Trees

Species _____
 Diameter _____
 Bearing _____
 Distance _____

Original Evidence Found

Year of search _____ By _____
 Monument found _____

Original Bearing Trees Found

Species _____
 Diameter _____
 Bearing _____
 Distance _____

Subsequent Corner Restoration

Year surveyed _____ By _____
 Where filed or recorded _____
 Monument _____
(Original, concrete post, iron rod, etc.)

Evidence of Subsequent Corner Restoration Found

Year of search 1984 By USFS
Recovered a 2 1/2" O.D. iron
pipe with a 3" dia. brass cap
strap, as shown:
Up 18"
Posts & BT's painted Red

T148NR26W
 535 | 536
 52 | 51
 T147N
 1963
 P.L.S. NO. 680A

Bearing Trees, Reference Objects

Species _____
 Diameter _____
 Bearing _____
 Distance _____

Bearing Trees, Reference Objects

<u>R. Maple</u>	<u>R. Maple</u>	<u>W. Birch</u>	<u>R. Maple</u>
<u>7.9"</u>	<u>9.0"</u>	<u>10.8"</u>	<u>12"</u>
<u>N64°E</u>	<u>S77°E</u>	<u>S88°W</u>	<u>N45°W</u>
<u>6.47'</u>	<u>35.98'</u>	<u>12.33'</u>	<u>74.70'</u>

Steel sign Post West & North

35

36

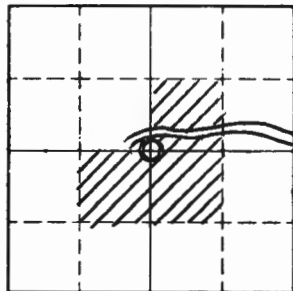

2

Sketch

1

○ Corner ▨ F.S. Land

Relation of Evidence to Record Features Along Section Lines

Section line to sections _____

Object _____

Record distance _____

Measured distance _____

Other Evidence

Describe evidence of use and occupation such as roads, fences, clearings, timber cutting lines, plantations, etc.. Cite source of testimony if any. *There is a road coming in off from Co. Rd 35 to that goes right by this corner.*

At time of search:

1. Did you have the record description?

Yes _____ No _____

2. How was search area located?

Pacing, chaining, photos, maps,
etc. _____

3. Man hours spent in search _____

4. Do you think additional search might
recover evidence? Yes _____ No _____

5. Signature _____

Perpetuation Record

Monument and accessories established. Include brief description of area. _____

Certified corner restoration certificate prepared: Yes _____ No _____

Filed in county records at _____ Date _____ County Document No. _____

Identified on aerial photo No. _____ Which is filed at _____