

	1	2	3	4	5	6	7	8	9	10	11	12	13	14	15	16	17	18	19	20	21	22	23	24	25
A																									
B	+	+	+			+	+	+		+	+	+		+	+	+		+	+	+		+	+	+	
C	+	6	+			+	5	+		+	4	+		+	3	+		+	2	+		+	1	+	
D	+	+	+			+	+	+		+	+	+		+	+	+		+	+	+		+	+	+	
E																									
F	+	+	+			+	+	+		+	+	+		+	+	+		+	+	+		+	+	+	
G	+	7	+			+	8	+		+	9	+		+	10	+		+	11	+		+	12	+	
H	+	+	+			+	+	+		+	+	+		+	+	+		+	+	+		+	+	+	
J																									
K	+	+	+			+	+	+		+	+	+		+	+	+		+	+	+		+	+	+	
L	●	+	18	+		+	17	+		+	16	+		+	15	+		+	14	+		+	13	+	
M	+	●	+			+	+	+		+	+	+		+	+	+		+	+	+		+	+	+	
N	+	+	+			+	+	+		+	+	+		+	+	+		+	+	+		+	+	+	
O	+	+	+			●	●	+		+	+	+		+	+	+		+	+	+		+	+	+	
P	●	●	●	●	+	●	+			+	21	+		+	22	+		+	23	+		+	24	+	
Q	●	●	●	●	+	●	+	●	●	+				+	+	+		+	+	+		+	+	+	
R	●	●	●	●		●		●	●																●
S	●	●	●		+	●	+			+	●	●	●	+	+	+		+	+	+		+	+	+	
T	+	30	●	●	●	29	●			+	28	+	●	+	●	+		+	26	+		+	25	+	
U	●	●	●	●	●	+				+	+	+		+	+	+		+	+	+		+	+	+	
V					●			●	●					●				●							●
W	●	+	+			+	+	+	●	●	+			+	+	+		+	+	+		+	+	+	
X	+	31	+			●	32	+		+	33	+	●	+	34	+	●	+	35	+		+	36	+	●
Y	+	+	+			+	+	+		+	+	+		+	+	●	+	+	+		+	+	+	+	
Z													●	●		●									●

LEGEND

○ = Corner having information on form 7100-52 in this file.

T145N R28W 5th PM

FILING INSTRUCTION

(Ref. FSM 7150)

File 7100-52 card record by letter and number coordinates behind the file guide for the township in which it falls.

File the 7100-52 card record by letter and then by number i.e., all A cards first, then B cards etc.

The first card behind the file guide (if data have been obtained and recorded) will be card A-1 for N.W. Township Corner, then card A-2 for 1/16 corner then card A-3 for 1/4 corner etc.

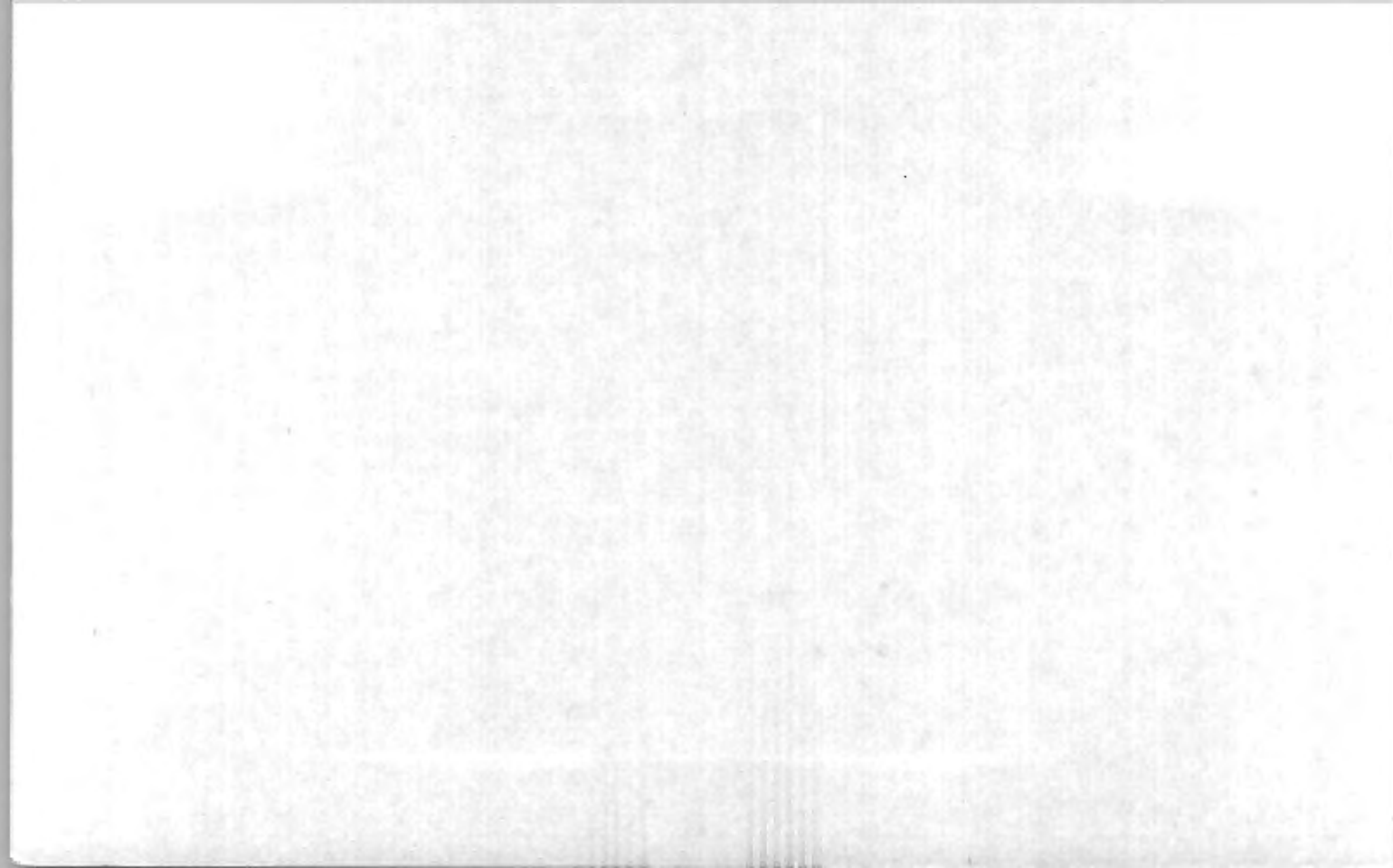

T. 145N R. 28W S. 5th Mer. N.F. Chippewa County Cass State MN  
1/4 Corner common to sections 13 18 and 145-29 145-28

## EXISTING SURVEYS

## Original Government Survey

Year surveyed 1874  
 Original monument Post  
(Wood post, stone, pile of stones, pipe, etc.)

## Bearing Trees

Species J. Pine Nor. Pine  
 Diameter 8" 20"  
 Bearing West N84 1/2° E  
 Distance 60 lks. 4 lks.  
39.60' 2.64'

## Subsequent Corner Restoration

Year surveyed 1955 By Harold Cum-Cass Co. Sur  
 Where filed or recorded Book #270  
 Monument 1 1/2" x 36" pipe  
(Original, concrete post, iron rod, etc.)

This corner was supposedly, set from J. Cara's  
temp. corner

## Bearing Trees, Reference Objects

Species J. Pine J. Pine  
 Diameter 14" 8"  
 Bearing S40°W Mag. N00°E Mag.  
 Distance 11.6' 4.9'

## Original Evidence Found

Year of search \_\_\_\_\_ By \_\_\_\_\_  
 Monument found \_\_\_\_\_

## Original Bearing Trees Found

Species \_\_\_\_\_  
 Diameter \_\_\_\_\_  
 Bearing \_\_\_\_\_  
 Distance \_\_\_\_\_

## Evidence of Subsequent Corner Restoration Found

Year of search 1958 By McDonald-Meyer

Corner was found to be marked by a 1 1/2" x 36"  
pipe. No original evidence found.

## Bearing Trees, Reference Objects

J. Pine J. Pine  
14" 8"  
S10°W true N79°E  
11.6' 4.9'  
No scribe -- just blazed

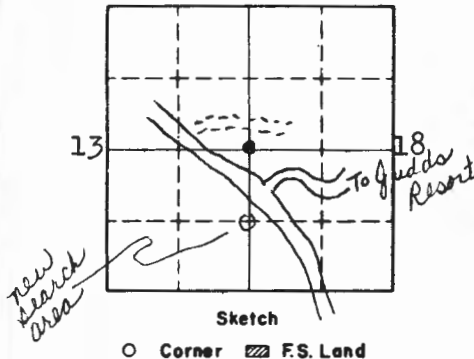

Relation of Evidence to Record Features Along Section Lines

Section line to sections	<u>13-18</u>	<u>13-18</u>
Object	<u>Ek. of dry marsh</u>	<u>N. Edge of Marsh</u>
Record distance	<u>6 chs=10.56'</u>	<u>25 chs=16.50'</u>
Measured distance	_____	_____

Other Evidence

Describe evidence of use and occupation such as roads, fences, clearings, timber cutting lines, plantations, etc.. Cite source of testimony if any. 7/9/80 Krause, McDonald & Hayes searched for original evidence in an area 600 - 900 S. and 0' to 250' West of the present brass cap set by Meyer. Area had been furrowed and planted (believe to be CCC work) Was covered with 10-30 Aspen & Hardwoods. Some of the planted J. Pine stumps were visible with some older Red & Jack Pine stumps around. No evidence was found.

At time of search:

1. Did you have the record description?  
Yes  No \_\_\_\_\_

2. How was search area located?  
Pacing, chaining, photos, maps,  
etc. \_\_\_\_\_

3. Man hours spent in search 2 1/2

4. Do you think additional search might recover evidence? Yes \_\_\_\_\_ No

5. Signature M. C. Hayes

Perpetuation Record

Monument and accessories established. Include brief description of area.  
1958. Set a 2" dia. x 5' long pipe w/brass tablet stamped:

Mark 3 new BT's.

W. Oak	R. Oak	J. Pine
8"	7"	9"
S22°E	N47 1/2°E	N6°E
44.5'	49.5'	39.8'

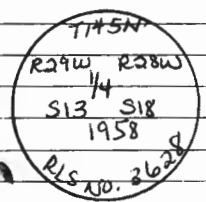

**CERTIFICATE FILED**

Certified corner restoration certificate prepared: Yes  No \_\_\_\_\_  
Filed in county records at Cass Date 4/21/60 County Document No. 11  
Identified on aerial photo No. \_\_\_\_\_ Which is filed at \_\_\_\_\_

T. 145 R. 28 5<sup>a</sup> Mer. N.F. Chippewa County Cass State Minnesota  
1/4 Corner common to sections 18 & 13 and  
T145-28 T145-29

EXISTING SURVEYS

Original Government Survey	Original Evidence Found
Year surveyed _____	Year of search _____ By _____
Original monument _____ <small>(Wood post, stone, pile of stones, pipe, etc.)</small>	Monument found _____
Bearing Trees	Original Bearing Trees Found
Species _____	Species _____
Diameter _____	Diameter <u>SEE RESTORATION CERT.</u>
Bearing _____	Bearing _____
Distance _____	Distance _____

Subsequent Corner Restoration	Evidence of Subsequent Corner Restoration Found
Year surveyed _____ By _____	Year of search <u>10-29-63</u> By <u>J.M. Morrison</u>
Where filed or recorded _____	<u>Corner is a brass cap. B.T. is a 9"</u>
Monument _____ <small>(Original, concrete post, iron rod, etc.)</small>	<u>Q. Pine which lies N 2° E 40' from corner</u>
	<u>tag is to a 12" dead Q. Pine. Corner</u>
	<u>lies 10' N of tag. This corner lies approximately</u>
	<u>75' S of road into summer home. Blue</u>
	<u>line painted 7' S of corner. Another</u>
	<u>tag is on a 10" Q. Pine. Corner lies</u>
	<u>5' West of tag.</u>
Bearing Trees, Reference Objects	
Species <u>Q. Pine</u>	
Diameter <u>9"</u>	
Bearing <u>N. 2° E</u>	
Distance <u>40'</u>	

Copy sent to S.O.

Relation of Evidence to Record Features Along Section Lines

145-29

145-28

13

18

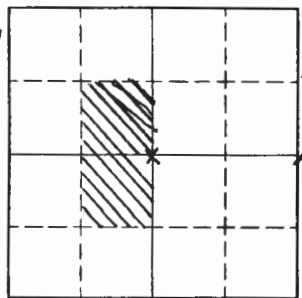

Sketch

○ Corner    ▨ F.S. Land

Section line to sections \_\_\_\_\_  
 Object \_\_\_\_\_  
 Record distance \_\_\_\_\_  
 Measured distance \_\_\_\_\_

Other Evidence

Describe evidence of use and occupation such as roads, fences, clearings, timber cutting lines, plantations, etc.. Cite source of testimony if any. \_\_\_\_\_

At time of search:

1. Did you have the record description?  
 Yes  No \_\_\_\_\_

2. How was search area located?  
 Pacing, chaining, photos, maps,  
 etc. \_\_\_\_\_

3. Man hours spent in search 1

4. Do you think additional search might  
 recover evidence? Yes \_\_\_\_\_ No

Perpetuation Record

Monument and accessories established. Include brief description of area. \_\_\_\_\_

Certified corner restoration certificate prepared: Yes \_\_\_\_\_ No \_\_\_\_\_

Filed in county records at \_\_\_\_\_ Date \_\_\_\_\_ County Document No. \_\_\_\_\_

Identified on aerial photo No. \_\_\_\_\_ Which is filed at \_\_\_\_\_

5. Signature S. M. Morrison

T. 145 R. 28 ~~28~~ 5th Mer. N.F. Chippewa County Cass State Minnesota  
3-1/16 Corner common to sections 13 & 18 T. 145-28 and 7.145-29

EXISTING SURVEYS

**Original Government Survey**

Year surveyed \_\_\_\_\_

Original monument \_\_\_\_\_  
(Wood post, stone, pile of stones, pipe, etc.)

Bearing Trees

Species Weed Cut!

Diameter \_\_\_\_\_

Bearing \_\_\_\_\_

Distance \_\_\_\_\_

**Original Evidence Found**

Year of search \_\_\_\_\_ By \_\_\_\_\_

Monument found \_\_\_\_\_

Original Bearing Trees Found

Species \_\_\_\_\_

Diameter \_\_\_\_\_

Bearing \_\_\_\_\_

Distance \_\_\_\_\_

**Subsequent Corner Restoration**

Year surveyed \_\_\_\_\_ By \_\_\_\_\_

Where filed or recorded \_\_\_\_\_

Monument \_\_\_\_\_  
(Original, concrete post, iron rod, etc.)

Bearing Trees, Reference Objects

Species \_\_\_\_\_

Diameter \_\_\_\_\_

Bearing \_\_\_\_\_

Distance \_\_\_\_\_

**Evidence of Subsequent Corner Restoration Found**

Year of search 10-29-63 By S. M. Morrison  
Tag is on NE side of 6" Red Oak. Iron  
pipe lies 4' 2" of tag. Blue line painted  
N of corner. This corner is at the SW  
corner of area cut over by Quad.  
for an air strip and was established  
by Harold Cure (surveyor at Walker)

Copy sent to S.O.

Relation of Evidence to Record Features Along Section Lines

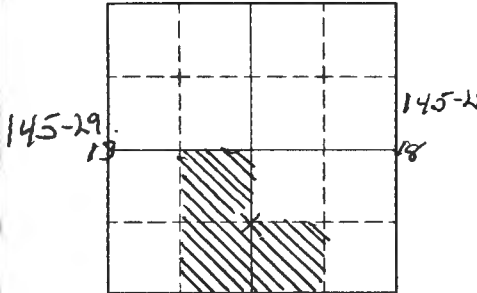

Sketch

○ Corner    ▨ F.S. Land

Section line to sections \_\_\_\_\_  
 Object \_\_\_\_\_  
 Record distance \_\_\_\_\_  
 Measured distance \_\_\_\_\_

Other Evidence

Describe evidence of use and occupation such as roads, fences, clearings, timber cutting lines, plantations, etc.. Cite source of testimony if any. \_\_\_\_\_

At time of search:

1. Did you have the record description?

Yes \_\_\_\_\_ No

2. How was search area located?

~~Pacing~~, chaining, photos, maps, etc. \_\_\_\_\_

3. Man hours spent in search 2

4. Do you think additional search might recover evidence? Yes \_\_\_\_\_ No

5. Signature *J. M. Morrison*

Perpetuation Record

Monument and accessories established. Include brief description of area. \_\_\_\_\_

Certified corner restoration certificate prepared: Yes \_\_\_\_\_ No \_\_\_\_\_

Filed in county records at \_\_\_\_\_ Date \_\_\_\_\_ County Document No. \_\_\_\_\_

Identified on aerial photo No. \_\_\_\_\_ Which is filed at \_\_\_\_\_



Index No. M-3  
(Alphabetical - Numerical)

LAND CORNER RECORD  
(RECTANGULAR SURVEYS)

RD-7150-4 (Rev. 6/13/67)  
 GPO 802-127

T. 145N. R. 28W. 5th Mer. N.F. Chippawa County Cass State MN  
Center South 1/16 Corner common to sections \_\_\_\_\_ and 18

EXISTING SURVEYS

Original Government Survey

Year surveyed \_\_\_\_\_  
 Original monument \_\_\_\_\_  
(Wood post, stone, pile of stones, pipe, etc.)

Bearing Trees

Species \_\_\_\_\_  
 Diameter \_\_\_\_\_  
 Bearing \_\_\_\_\_  
 Distance \_\_\_\_\_

Subsequent Corner Restoration

Year surveyed \_\_\_\_\_ By \_\_\_\_\_  
 Where filed or recorded \_\_\_\_\_  
 Monument \_\_\_\_\_  
(Original, concrete post, iron rod, etc.)

Bearing Trees, Reference Objects

Species \_\_\_\_\_  
 Diameter \_\_\_\_\_  
 Bearing \_\_\_\_\_  
 Distance \_\_\_\_\_

Original Evidence Found

Year of search \_\_\_\_\_ By \_\_\_\_\_  
 Monument found \_\_\_\_\_

Original Bearing Trees Found

Species \_\_\_\_\_  
 Diameter \_\_\_\_\_  
 Bearing \_\_\_\_\_  
 Distance \_\_\_\_\_

Evidence of Subsequent Corner Restoration Found

Year of search \_\_\_\_\_ By \_\_\_\_\_  
See Restoration Certificate

Bearing Trees, Reference Objects

Species \_\_\_\_\_  
 Diameter \_\_\_\_\_  
 Bearing \_\_\_\_\_  
 Distance \_\_\_\_\_

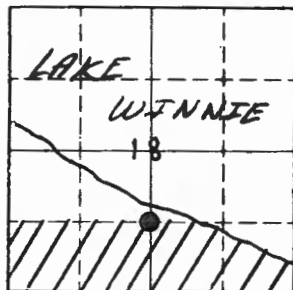

Sketch

○ Corner    ▨ F.S. Land

Relation of Evidence to Record Features Along Section Lines

Section line to sections \_\_\_\_\_  
 Object \_\_\_\_\_  
 Record distance \_\_\_\_\_  
 Measured distance \_\_\_\_\_

Other Evidence

Describe evidence of use and occupation such as roads, fences, clearings, timber cutting lines, plantations, etc.. Cite source of testimony if any. \_\_\_\_\_

At time of search:

1. Did you have the record description?  
 Yes \_\_\_\_\_ No \_\_\_\_\_

2. How was search area located?  
 Pacing, chaining, photos, maps,  
 etc. \_\_\_\_\_

3. Man hours spent in search \_\_\_\_\_

4. Do you think additional search might  
 recover evidence? Yes \_\_\_\_\_ No \_\_\_\_\_

5. Signature \_\_\_\_\_

Perpetuation Record

Monument and accessories established. Include brief description of area. \_\_\_\_\_

SET 2" X 5' IRON PIPE WITH CAP MKD.

OAK 10 S16E 42.46' MKD BT N+D

OAK 10 S45E 68.85' " BT N+D

BIRCH 3 S77W 13.77' " BT N+D

Fd. 3/4" IRON PIPE NORTH 108.28' FROM 2" MONU.

Certified corner restoration certificate prepared: Yes \_\_\_\_\_ No \_\_\_\_\_

Filed in county records at \_\_\_\_\_ Date \_\_\_\_\_ County Document No. \_\_\_\_\_

Identified on aerial photo No. \_\_\_\_\_ Which is filed at \_\_\_\_\_

T. 145 N. R. 28W Section 5 Mer. N.F. Chippewa County Cass State MN  
 Corner common to sections 13, 24, 18 and 19  
145-29 145-28

## EXISTING SURVEYS

## Original Government Survey

Year surveyed 1874  
 Original monument post  
(Wood post, stone, pile of stones, pipe, etc.)

Species	J. Pine	J. Pine	J. Pine	J. Pine
Diameter	12"	8"	10"	7"
Bearing	N31°E	N19°W	S165°W	S60°E
Distance	23 1/2'	15 1/8'	46 1/2'	12 1/2'
	15.18'	9.9'	30.36'	7.92'

## Subsequent Corner Restoration

Year surveyed 7-11-63 By B. McDonald, W. Ockerman  
 Where filed or recorded Cass County & U.S.F.S. Book #1 Page #4  
 Monument 2" dia x 5' long pipe w/ brass tablet  
(Original, concrete post, iron rod, etc.)

**CERTIFICATE FILED**

Species	J. Pine	Oak	J. Pine
Diameter	6"	6"	11"
Bearing	N65 1/2°W	N44°E	S53 1/2°W
Distance	61.3'	126.5'	137.5'
			56.7'

Steel 5"gn Post South 4.25'

## Original Evidence Found

Year of search 7/11/63 By V. Holman, B. McDonald, W. Ockerman  
 Monument found \_\_\_\_\_

## Original Bearing Trees Found

Species	Stump hole w/ charred pine	Charred stump	Stump hole w/ charred pieces	Stump hole w/ charred pieces
Diameter				
Bearing	N31°E	N19°W	S165°W	S60°E
Distance	15.18'	9.9'	30.36'	7.92'

## Evidence of Subsequent Corner Restoration Found

Year of search 7/1/63 By Klaus M. Donald, Hayes  
found monument in place and good condition

## Bearing Trees, Reference Objects

Species	J. Pine	Oak	J. Pine
Diameter			
Bearing			
Distance			

*still standing (not measured)*      *no evidence was seen*      *no evidence was seen*      *still standing (not measured)*

Relation of Evidence to Record Features Along Section Lines

Section line to sections	_____	_____	_____
Object	_____	_____	_____
Record distance	_____	_____	_____
Measured distance	_____	_____	_____

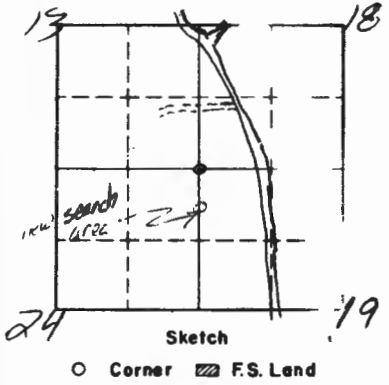

Sketch

O Corner F.S. Land

Other Evidence

Describe evidence of use and occupation such as roads, fences, clearings, timber cutting lines, plantations, etc. Cite source of testimony if any. 7/9/80 Kraus, McReynolds & Hays. Found 4 hole depressions at the bearing and dist. of the original B.T.S. (Possible holes caused by pulling roots & stump out) The area is now a Red Pine Plantation approx. 10 yrs old so area has been heavily disturbed. Has searched to original evidence an area 650-750' South and in E-W of present brass cap. No evidence found. Some of this area had been disturbed and planted about 40-50 yrs ago.

Perpetuation Record

Monument and accessories established. Include brief description of area. \_\_\_\_\_

\_\_\_\_\_

\_\_\_\_\_

\_\_\_\_\_

\_\_\_\_\_

At time of search:

1. Did you have the record description?

Yes  No \_\_\_\_\_

2. How was search area located?

Pacing, chaining, photos, maps, etc. \_\_\_\_\_

3. Man hours spent in search 2

4. Do you think additional search might recover evidence? Yes \_\_\_\_\_ No

5. Signature M. C. Hays

Certified corner restoration certificate prepared: Yes  No \_\_\_\_\_

Filed in county records at Pass. Co. Date 9/16/83 County Document No. 1166

Identified on aerial photo No. \_\_\_\_\_ Which is filed at \_\_\_\_\_

T. 145N R. 28W  
NORTH 1/16Mer. N.F. Chippewa County CassState MN  
19 and 24  
145-28 145-29

Corner common to sections \_\_\_\_\_

## EXISTING SURVEYS

## Original Government Survey

Year surveyed \_\_\_\_\_  
Original monument \_\_\_\_\_  
(Wood post, stone, pile of stones, pipe, etc.)

## Bearing Trees

Species \_\_\_\_\_  
Diameter \_\_\_\_\_  
Bearing \_\_\_\_\_  
Distance \_\_\_\_\_

## Subsequent Corner Restoration

Year surveyed 7/18/68 By Lyle Elliott  
Where filed or recorded U.S.F.S., Book # 23  
Monument 2" x 5" galvanized pipe, filled w/concrete  
w/ bronze tablet stamped: T145N  
R28W 1/16 R28W  
S24 S19

## Bearing Trees, Reference Objects

Species J. Pine J. Pine J. Pine 1 1/2" Cedar Post  
Diameter 4" 9" 9" 4x4x60  
Bearing N17°E N04°30'W S38°E North  
Distance 34.01' 43.45' 60.90' 10.0'  
Scribed 1/16 S19BT 1/16 S24BT 1/16 S19BT

## Original Evidence Found

Year of search \_\_\_\_\_ By \_\_\_\_\_  
Monument found \_\_\_\_\_

## Original Bearing Trees Found

Species \_\_\_\_\_  
Diameter \_\_\_\_\_  
Bearing \_\_\_\_\_  
Distance \_\_\_\_\_

## Evidence of Subsequent Corner Restoration Found

Year of search \_\_\_\_\_ By \_\_\_\_\_

## Bearing Trees, Reference Objects

Species \_\_\_\_\_  
Diameter \_\_\_\_\_  
Bearing \_\_\_\_\_  
Distance \_\_\_\_\_  
Scribed \_\_\_\_\_

Relation of Evidence to Record Features Along Section Lines

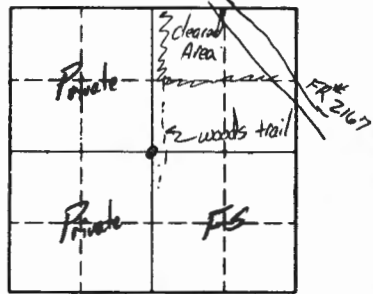

Sketch

○ Corner    ▨ F.S. Land

Section line to sections \_\_\_\_\_

Object \_\_\_\_\_

Record distance \_\_\_\_\_

Measured distance \_\_\_\_\_

Other Evidence

Describe evidence of use and occupation such as roads, fences, clearings, timber cutting lines, plantations, etc.. Cite source of testimony if any. \_\_\_\_\_

At time of search: \_\_\_\_\_

1. Did you have the record description?  
Yes \_\_\_\_\_ No \_\_\_\_\_

2. How was search area located?  
Pacing, chaining, photos, maps,  
etc. \_\_\_\_\_

3. Man hours spent in search \_\_\_\_\_

4. Do you think additional search might  
recover evidence? Yes \_\_\_\_\_ No \_\_\_\_\_

Perpetuation Record

Monument and accessories established. Include brief description of area. \_\_\_\_\_

Certified corner restoration certificate prepared: Yes \_\_\_\_\_ No

Filed in county records at \_\_\_\_\_ Date \_\_\_\_\_ County Document No. \_\_\_\_\_

5. Signature M. C. Brown

Identified on aerial photo No. \_\_\_\_\_ Which is filed at \_\_\_\_\_

*entered data from Field Book*

T. 145 R. 28 5<sup>th</sup> Mer. N.F. Chippewa County Cass State Minnesota  
NW 1/4 Corner common to sections NW 14 20, and

EXISTING SURVEYS

Original Government Survey	Original Evidence Found
Year surveyed _____ Original monument _____ <small>(Wood post, stone, pile of stones, pipe, etc.)</small>	Year of search _____ By _____ Monument found _____
<p style="text-align: center;">Bearing Trees</p> Species _____ Diameter _____ Bearing _____ Distance _____	<p style="text-align: center;">Original Bearing Trees Found</p> Species _____ Diameter _____ Bearing _____ Distance _____
Subsequent Corner Restoration	Evidence of Subsequent Corner Restoration Found
Year surveyed _____ By _____ Where filed or recorded _____ Monument _____ <small>(Original, concrete post, iron rod, etc.)</small> <p style="text-align: center;">Bearing Trees, Reference Objects</p> Species _____ Diameter _____ Bearing _____ Distance _____	Year of search <u>7-7-64</u> By <u>Morris O. Tucker</u> <u>New tag on S side of 20" red pine, also</u> <u>old tag on W. side of same tree - approx</u> <u>corner lies 20' 3" of tag - another tag on N.</u> <u>side of 12" birch 10 lbs N on lake shore.</u> <u>Blue line painted N<sup>2</sup> E of corner. No brass</u> <u>caps or B.T.S. line to east is also old</u> <u>blazed line.</u>

Copy to S.O.

OVER →

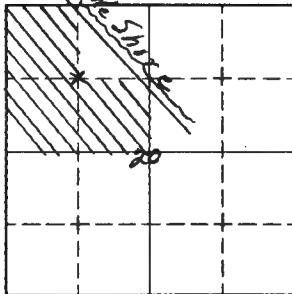

Sketch

○ Corner    ▨ F.S. Land

Relation of Evidence to Record Features Along Section Lines

Section line to sections \_\_\_\_\_  
 Object \_\_\_\_\_  
 Record distance \_\_\_\_\_  
 Measured distance \_\_\_\_\_

Other Evidence

Describe evidence of use and occupation such as roads, fences, clearings, timber cutting lines, plantations, etc.. Cite source of testimony if any. \_\_\_\_\_  
 \_\_\_\_\_  
 \_\_\_\_\_  
 \_\_\_\_\_  
 \_\_\_\_\_

At time of search:

1. Did you have the record description?

Yes \_\_\_\_\_ No

2. How was search area located?

\*Pacing, chaining, photos, maps, etc. \_\_\_\_\_  
 \_\_\_\_\_  
 \_\_\_\_\_

3. Man hours spent in search 1

4. Do you think additional search might recover evidence? Yes \_\_\_\_\_ No

5. Signature A. Morrison

Perpetuation Record

Monument and accessories established. Include brief description of area. \_\_\_\_\_

1/4/90 CK, GB

Found 23" R. Pine with tags for the approx. NW 1/4.  
Placed ribbons on the line east of this position.  
Found old blaze line.

Certified corner restoration certificate prepared: Yes \_\_\_\_\_ No \_\_\_\_\_

Filed in county records at \_\_\_\_\_ Date \_\_\_\_\_ County Document No. \_\_\_\_\_

Identified on aerial photo No. \_\_\_\_\_ Which is filed at \_\_\_\_\_



Index No. 0-7  
(Alphabetical - Numerical)

LAND CORNER RECORD  
(RECTANGULAR SURVEYS)

T. 145 R. 28 5<sup>th</sup> Mer. N.F. Chippewa County Cass State Minnesota  
 Corner common to sections 20 and \_\_\_\_\_

EXISTING SURVEYS

Original Government Survey	Original Evidence Found
Year surveyed _____ Original monument _____ <small>(Wood post, stone, pile of stones, pipe, etc.)</small>	Year of search _____ By _____ Monument found _____
<p style="text-align: center;">Bearing Trees</p> Species _____ Diameter _____ Bearing _____ Distance _____	<p style="text-align: center;">Original Bearing Trees Found</p> Species _____ Diameter _____ Bearing _____ Distance _____
Subsequent Corner Restoration	Evidence of Subsequent Corner Restoration Found
Year surveyed _____ By _____ Where filed or recorded _____ Monument _____ <small>(Original, concrete post, iron rod, etc.)</small>	Year of search <u>7-7-64</u> By <u>Morrison &amp; Tucker</u> <u>tag on W side of 8" aspen, cis on north</u> <u>side of Richards townsite Campground</u> <u>approx Corner 1/4 Ch. east of tag</u> <u>and is in lake. Blue line painted</u> <u>W of corner - this is also an old</u> <u>blazed line.</u>
<p style="text-align: center;">Bearing Trees, Reference Objects</p> Species _____ Diameter _____ Bearing _____ Distance _____	_____ _____ _____

OVER →

Copy to D.O.

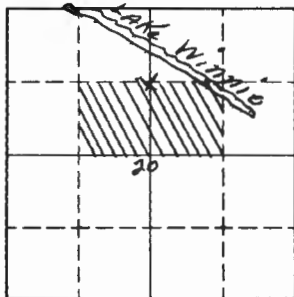

Sketch

○ Corner    ▨ F.S. Land

Relation of Evidence to Record Features Along Section Lines

Section line to sections \_\_\_\_\_  
 Object \_\_\_\_\_  
 Record distance \_\_\_\_\_  
 Measured distance \_\_\_\_\_

Other Evidence

Describe evidence of use and occupation such as roads, fences, clearings, timber cutting lines, plantations, etc.. Cite source of testimony if any. \_\_\_\_\_  
 \_\_\_\_\_  
 \_\_\_\_\_  
 \_\_\_\_\_  
 \_\_\_\_\_

At time of search:

1. Did you have the record description?

Yes \_\_\_\_\_ No

2. How was search area located?

Pacing, chaining, photos, maps,  
 etc. \_\_\_\_\_  
 \_\_\_\_\_

3. Man hours spent in search 1

4. Do you think additional search might recover evidence? Yes \_\_\_\_\_ No

5. Signature S.M. Morrison

Perpetuation Record

Monument and accessories established. Include brief description of area. \_\_\_\_\_

1/4/90 CK, GB

Approx. tag set by Stan in 7/7/64 falls in Lake WINNIE. Ran ribbon line west along old blaze line today.

Certified corner restoration certificate prepared: Yes \_\_\_\_\_ No \_\_\_\_\_

Filed in county records at \_\_\_\_\_ Date \_\_\_\_\_ County Document No. \_\_\_\_\_

Identified on aerial photo No. \_\_\_\_\_ Which is filed at \_\_\_\_\_

Index No. 0-7  
(Alphabetical - Numerical)

LAND CORNER RECORD  
(RECTANGULAR SURVEYS)

RP-7150-4 (Rev. 6/13/67)  
GPO 802-127

T. 14S R. 28 S. 5 Mer. N.F. CHIPPEWA County CASS State MN.  
CENTER NORTH 1/16 Corner common to sections \_\_\_\_\_ and 20

EXISTING SURVEYS

Original Government Survey

Year surveyed \_\_\_\_\_  
Original monument \_\_\_\_\_  
(Wood post, stone, pile of stones, pipe, etc.)

Bearing Trees

Species \_\_\_\_\_  
Diameter \_\_\_\_\_  
Bearing \_\_\_\_\_  
Distance \_\_\_\_\_

Subsequent Corner Restoration

Year surveyed 5-12-37 By J. A. GJELHAUG  
Where filed or recorded OLD CCC BK # 88 Pg. 43  
Monument SET OAK POST 3" x 4' x 1" x 20" IRON PIPE  
(Original, concrete post, iron rod, etc.)

MKD NEW BT'S.

Bearing Trees, Reference Objects

Species W. OAK J. PINE  
Diameter 4 7  
Bearing N 60 E N 8 E  
Distance 20 LKS. 21 LKS.  
13.2' 13.9'

Original Evidence Found

Year of search \_\_\_\_\_ By \_\_\_\_\_  
Monument found \_\_\_\_\_

Original Bearing Trees Found

Species \_\_\_\_\_  
Diameter \_\_\_\_\_  
Bearing \_\_\_\_\_  
Distance \_\_\_\_\_

Evidence of Subsequent Corner Restoration Found

Year of search \_\_\_\_\_ By \_\_\_\_\_  
\_\_\_\_\_  
\_\_\_\_\_

Bearing Trees, Reference Objects

\_\_\_\_\_  
\_\_\_\_\_  
\_\_\_\_\_  
\_\_\_\_\_

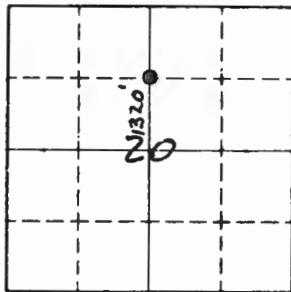

Sketch

○ Corner    ▨ F.S. Land

Relation of Evidence to Record Features Along Section Lines

Section line to sections \_\_\_\_\_  
 Object \_\_\_\_\_  
 Record distance \_\_\_\_\_  
 Measured distance \_\_\_\_\_

Other Evidence

Describe evidence of use and occupation such as roads, fences, clearings, timber cutting lines, plantations, etc.. Cite source of testimony if any. \_\_\_\_\_

20.00 CHS. NORTH OF C<sup>1</sup>/<sub>4</sub> - 1320'

At time of search:

1. Did you have the record description?

Yes  No \_\_\_\_\_

2. How was search area located?

Pacing, chaining, photos, maps,  
 etc. \_\_\_\_\_

3. Man hours spent in search \_\_\_\_\_

4. Do you think additional search might  
 recover evidence? Yes \_\_\_\_\_ No \_\_\_\_\_

5. Signature Curt Krause

Perpetuation Record

Monument and accessories established. Include brief description of area. \_\_\_\_\_

Certified corner restoration certificate prepared: Yes \_\_\_\_\_ No \_\_\_\_\_

Filed in county records at \_\_\_\_\_ Date \_\_\_\_\_ County Document No. \_\_\_\_\_

Identified on aerial photo No. \_\_\_\_\_ Which is filed at \_\_\_\_\_

Index No. P-1  
(Alphabetical - Numerical)

*Book #1  
 Page #12*

LAND CORNER RECORD  
(RECTANGULAR SURVEYS)

R9-7150-4 (Rev. 6/13/67)  
 GPO 802-127

T. 145N R. 20W 5 Mer. N.F. Chippewa County Cass State Mn  
14 Corner common to sections 19 and 24  
145-29 145-29

EXISTING SURVEYS

Original Government Survey

Year surveyed 1873  
 Original monument Wood post  
(Wood post, stone, pile of stones, pipe, etc.)

Bearing Trees

Species	J. Pine	N. Pine
Diameter	7"	24"
Bearing	N 13 1/2° E	S 74° W
Distance	24 1/2'	73 1/2'
	15.84'	48.18'

Subsequent Corner Restoration

Year surveyed 7/5/1968 By Oberman, Krause  
 Where filed or recorded U.S.F.S. Set by Privateer Marsure  
 Monument 2" dia x .5' long pipe w/ brass cap  
(Original, concrete post, iron rod, etc.)  
RLS # 6807

Bearing Trees, Reference Objects

Species	Jack Pine	J. Pine	N. Pine
Diameter	12"	4"	9"
Bearing	N 8° E	N 88° W	S 19° E
Distance	45.53'	66.08'	92.87'

Original Evidence Found

Year of search \_\_\_\_\_ By \_\_\_\_\_  
 Monument found \_\_\_\_\_

Original Bearing Trees Found

Species	_____
Diameter	_____
Bearing	_____
Distance	_____

Evidence of Subsequent Corner Restoration Found

Year of search \_\_\_\_\_ By \_\_\_\_\_  
 \_\_\_\_\_  
 \_\_\_\_\_  
 \_\_\_\_\_

Bearing Trees, Reference Objects

Species	_____
Diameter	_____
Bearing	_____
Distance	_____

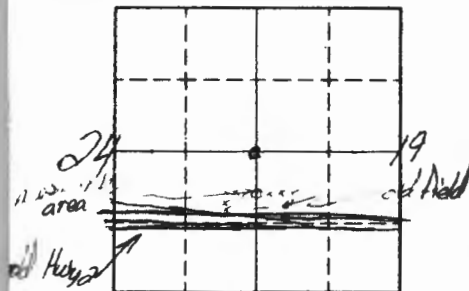

Sketch

○ Corner    ▨ F.S. Land

At time of search:

1. Did you have the record description?

Yes  No 

2. How was search area located?

Pacing, chaining, photos, maps,  
etc.3. Man hours spent in search 2

4. Do you think additional search might

recover evidence? Yes  No 5. Signature MC Hayes

Section line to sections \_\_\_\_\_

Object \_\_\_\_\_

Record distance \_\_\_\_\_

Measured distance \_\_\_\_\_

## Other Evidence

Describe evidence of use and occupation such as roads, fences, clearings, timber cutting lines, plantations, etc.. Cite source of testimony if any. 7/9/80 House, McLeod, Hayes  
Searched for original evidence in an area approx 350' south of  
present brass cap. Found down line at NW corner of old field. Found  
in use in 1939 aerial photo. Large ring stump at west edge of field  
(appears to have been pulled from field). Planned to check old Hwy 2  
things as it is only open south. Should also check for Plat of  
old Ryan Indian V. Page. Did not visit existing monument.  
Aug. 80 - Bert Edwards says old plans are nonexistent. (Hwy 2)

## Perpetuation Record

Monument and accessories established. Include brief description of area. \_\_\_\_\_

Certified corner restoration certificate prepared: Yes \_\_\_\_\_ No 

Filed in county records at \_\_\_\_\_ Date \_\_\_\_\_ County Document No. \_\_\_\_\_

Identified on aerial photo No. \_\_\_\_\_ Which is filed at \_\_\_\_\_

T. 145 R. 28 5<sup>th</sup> Mer. N.F. Chippewa County Cass State Minnesota  
 W 1/16 Corner common to sections 19 and \_\_\_\_\_

EXISTING SURVEYS

Original Government Survey	Original Evidence Found
Year surveyed _____	Year of search _____ By _____
Original monument _____ <small>(Wood post, stone, pile of stones, pipe, etc.)</small>	Monument found _____
Bearing Trees	Original Bearing Trees Found
Species _____	Species _____
Diameter _____	Diameter _____
Bearing _____	Bearing _____
Distance _____	Distance _____
Subsequent Corner Restoration	Evidence of Subsequent Corner Restoration Found
Year surveyed _____ By _____	Year of search <u>8-12-64</u> By <u>Morrison B. Tucker</u>
Where filed or recorded _____	<u>Tag on N. side of 10" J. Pine - Blue</u>
Monument _____ <small>(Original, concrete post, iron rod, etc.)</small>	<u>line painted E &amp; W. Tag is approximately</u>
_____	<u>Corner. No brass caps or B.T.'s. Corner</u>
_____	<u>established by Compass &amp; Chaining</u>
_____	<u>between Corners to E &amp; W - E.W. line</u>
_____	<u>run on approx. 2° magnetic</u>
_____	<u>declination.</u>
Bearing Trees, Reference Objects	_____
Species _____	_____
Diameter _____	_____
Bearing _____	_____
Distance _____	_____

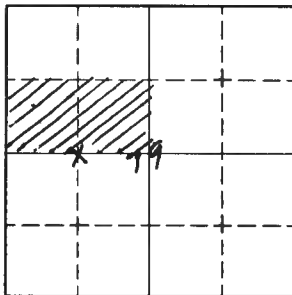

Sketch

○ Corner    ▨ F.S. Land

Relation of Evidence to Record Features Along Section Lines

Section line to sections \_\_\_\_\_  
 Object \_\_\_\_\_  
 Record distance \_\_\_\_\_  
 Measured distance \_\_\_\_\_

Other Evidence

Describe evidence of use and occupation such as roads, fences, clearings, timber cutting lines, plantations, etc.. Cite source of testimony if any. \_\_\_\_\_  
 \_\_\_\_\_  
 \_\_\_\_\_  
 \_\_\_\_\_  
 \_\_\_\_\_

At time of search:

1. Did you have the record description?

Yes \_\_\_\_\_ No

2. How was search area located?

Recon, chaining, photos, maps,  
 etc. \_\_\_\_\_  
 \_\_\_\_\_

3. Man hours spent in search 2

4. Do you think additional search might  
 recover evidence? Yes \_\_\_\_\_ No

5. Signature J. M. Morrison

Perpetuation Record

Monument and accessories established. Include brief description of area. \_\_\_\_\_  
 \_\_\_\_\_  
 \_\_\_\_\_  
 \_\_\_\_\_  
 \_\_\_\_\_

Certified corner restoration certificate prepared: Yes \_\_\_\_\_ No \_\_\_\_\_

Filed in county records at \_\_\_\_\_ Date    /    /    County Document No. \_\_\_\_\_

Identified on aerial photo No. \_\_\_\_\_ Which is filed at \_\_\_\_\_



T. 145 R. 28 1/4 Mer. N.F. 5<sup>th</sup> Chippewa County Cass State Minnesota  
 Corner common to sections Center of 19 and \_\_\_\_\_

EXISTING SURVEYS

Original Government Survey	Original Evidence Found
Year surveyed _____ Original monument _____ <small>(Wood post, stone, pile of stones, pipe, etc.)</small>	Year of search _____ By _____ Monument found _____
<p style="text-align: center;">Bearing Trees</p> Species _____ Diameter _____ Bearing _____ Distance _____	<p style="text-align: center;">Original Bearing Trees Found</p> Species _____ Diameter _____ Bearing _____ Distance _____
<p style="text-align: center;">Subsequent Corner Restoration</p>	<p style="text-align: center;">Evidence of Subsequent Corner Restoration Found</p>
Year surveyed _____ By _____ Where filed or recorded _____ Monument _____ <small>(Original, concrete post, iron rod, etc.)</small> <p style="text-align: center;">Bearing Trees, Reference Objects</p> Species _____ Diameter _____ Bearing _____ Distance _____	Year of search <u>7-16-63</u> By <u>J. M. Morrison</u> <u>Tag on E. side 48" J. Pine - Blue line</u> <u>pointed E. of corner. <del>Set monument post</del></u> <u>sets 7ft South of tag. No brass Ciper</u> <u>B.T.'s. This approximate corner established</u> <u>by Morrison &amp; Naltre. Another tag on</u> <u>W. side of Schmieder Road 10 Chins</u> <u>West. E. -</u>

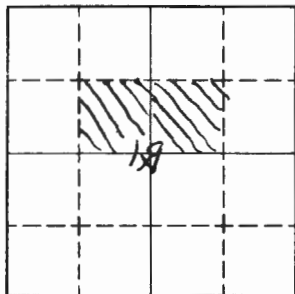

Sketch

○ Corner    ▨ F.S. Land

Relation of Evidence to Record Features Along Section Lines

Section line to sections \_\_\_\_\_  
 Object \_\_\_\_\_  
 Record distance \_\_\_\_\_  
 Measured distance \_\_\_\_\_

Other Evidence

Describe evidence of use and occupation such as roads, fences, clearings, timber cutting lines, plantations, etc.. Cite source of testimony if any. \_\_\_\_\_  
 \_\_\_\_\_  
 \_\_\_\_\_  
 \_\_\_\_\_  
 \_\_\_\_\_

At time of search:

1. Did you have the record description?

Yes \_\_\_\_\_ No

2. How was search area located?

Racing, chaining, photos, maps,  
 etc. \_\_\_\_\_  
 \_\_\_\_\_

3. Man hours spent in search 1

4. Do you think additional search might  
 recover evidence? Yes \_\_\_\_\_ No

5. Signature J.M. Morrison

Perpetuation Record

Monument and accessories established. Include brief description of area. \_\_\_\_\_  
 \_\_\_\_\_  
 \_\_\_\_\_  
 \_\_\_\_\_  
 \_\_\_\_\_

Certified corner restoration certificate prepared: Yes \_\_\_\_\_ No \_\_\_\_\_

Filed in county records at \_\_\_\_\_ Date \_\_\_\_\_ County Document No. \_\_\_\_\_

Identified on aerial photo No. \_\_\_\_\_ Which is filed at \_\_\_\_\_

T. 145 R. 28 5a Mer. N.F. Chippewa County Cass State Minnesota  
E 1/4 Corner common to sections 19 and

EXISTING SURVEYS

**Original Government Survey**

Year surveyed \_\_\_\_\_

Original monument \_\_\_\_\_  
(Wood post, stone, pile of stones, pipe, etc.)

**Bearing Trees**

Species \_\_\_\_\_

Diameter \_\_\_\_\_

Bearing \_\_\_\_\_

Distance \_\_\_\_\_

**Original Evidence Found**

Year of search \_\_\_\_\_ By \_\_\_\_\_

Monument found \_\_\_\_\_

**Original Bearing Trees Found**

Species \_\_\_\_\_

Diameter \_\_\_\_\_

Bearing \_\_\_\_\_

Distance \_\_\_\_\_

**Subsequent Corner Restoration**

Year surveyed \_\_\_\_\_ By \_\_\_\_\_

Where filed or recorded \_\_\_\_\_

Monument \_\_\_\_\_  
(Original, concrete post, iron rod, etc.)

**Bearing Trees, Reference Objects**

Species \_\_\_\_\_

Diameter \_\_\_\_\_

Bearing \_\_\_\_\_

Distance \_\_\_\_\_

**Evidence of Subsequent Corner Restoration Found**

Year of search 5-29-63 By Morrison & Rolfs  
Tag on N. side of 8" <sup>iron</sup> post, 5 ft. high  
which is an old plantation post.  
Blue line painted E. No brass  
cap or B.T.'s. This approx corner  
established by Morrison <sup>with</sup> ~~with~~ <sup>work</sup>  
by chaining from corner 1/4 mi. E.  
& corners to W.  
This E-W line run in approp  
2° magnetic declination

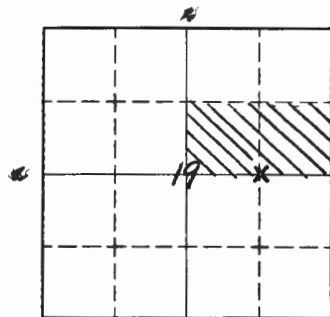

Sketch

○ Corner    ▨ F.S. Land

Relation of Evidence to Record Features Along Section Lines

Section line to sections \_\_\_\_\_  
 Object \_\_\_\_\_  
 Record distance \_\_\_\_\_  
 Measured distance \_\_\_\_\_

Other Evidence

Describe evidence of use and occupation such as roads, fences, clearings, timber cutting lines, plantations, etc.. Cite source of testimony if any. \_\_\_\_\_  
 \_\_\_\_\_  
 \_\_\_\_\_  
 \_\_\_\_\_  
 \_\_\_\_\_

Perpetuation Record

Monument and accessories established. Include brief description of area. \_\_\_\_\_  
 \_\_\_\_\_  
 \_\_\_\_\_  
 \_\_\_\_\_  
 \_\_\_\_\_

Certified corner restoration certificate prepared:      Yes \_\_\_\_\_ No \_\_\_\_\_

Filed in county records at \_\_\_\_\_ Date \_\_\_\_\_ County Document No. \_\_\_\_\_

Identified on aerial photo No. \_\_\_\_\_ Which is filed at \_\_\_\_\_

\_\_\_\_\_

At time of search:

1. Did you have the record description?

Yes \_\_\_\_\_ No

2. How was search area located?

~~Recon~~, chaining, photos, maps,  
 etc. \_\_\_\_\_  
 \_\_\_\_\_

3. Man hours spent in search 1

4. Do you think additional search might

recover evidence? Yes \_\_\_\_\_ No

5. Signature L. M. Morrison

T. 145 R. 28 Mer. N.F. Chippewa County Casa State Minnesota  
114 Corner common to sections 19 & 20 and

EXISTING SURVEYS

Original Government Survey

Year surveyed \_\_\_\_\_  
 Original monument \_\_\_\_\_  
(Wood post, stone, pile of stones, pipe, etc.)

Bearing Trees

Species \_\_\_\_\_  
 Diameter Needle C.T.  
 Bearing \_\_\_\_\_  
 Distance \_\_\_\_\_

Original Evidence Found

Year of search \_\_\_\_\_ By \_\_\_\_\_  
 Monument found \_\_\_\_\_

Original Bearing Trees Found

Species \_\_\_\_\_  
 Diameter \_\_\_\_\_  
 Bearing \_\_\_\_\_  
 Distance \_\_\_\_\_

Subsequent Corner Restoration

Year surveyed \_\_\_\_\_ By \_\_\_\_\_  
 Where filed or recorded \_\_\_\_\_  
 Monument \_\_\_\_\_  
(Original, concrete post, iron rod, etc.)

Bearing Trees, Reference Objects

Species Aspen  
 Diameter 7"  
 Bearing S. 36 W.  
 Distance 25 lbs. of corner

Evidence of Subsequent Corner Restoration Found

Year of search 5-29-63 By Morrison & Roles  
Tag on N. side of 8" Aspen. Squared  
stake laid 7.3 ft. N. of tag. C.T. is a  
7" Aspen which lies approx. 25 lbs.  
5.36' W of Corner. Blue line painted  
5' N. of Corner. This Corner should  
be re-established if possible

Copy to S.O.

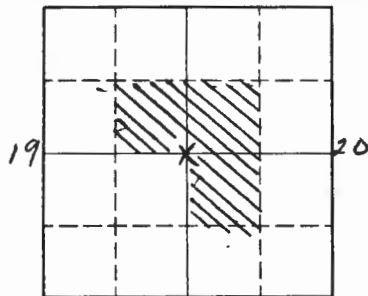

Sketch

○ Corner    ▨ F.S. Land

Relation of Evidence to Record Features Along Section Lines

Section line to sections \_\_\_\_\_  
 Object \_\_\_\_\_  
 Record distance \_\_\_\_\_  
 Measured distance \_\_\_\_\_

Other Evidence

Describe evidence of use and occupation such as roads, fences, clearings, timber cutting lines, plantations, etc.. Cite source of testimony if any. \_\_\_\_\_  
 \_\_\_\_\_  
 \_\_\_\_\_  
 \_\_\_\_\_  
 \_\_\_\_\_

At time of search:

1. Did you have the record description?

Yes  No \_\_\_\_\_

2. How was search area located?

Pacing, chaining, photos, maps,  
 etc. \_\_\_\_\_  
 \_\_\_\_\_

3. Man hours spent in search 1

4. Do you think additional search might  
 recover evidence? Yes  No \_\_\_\_\_

5. Signature *J.M. Morrison*

Perpetuation Record

Monument and accessories established. Include brief description of area. \_\_\_\_\_  
 \_\_\_\_\_  
 \_\_\_\_\_  
 \_\_\_\_\_  
 \_\_\_\_\_

Certified corner restoration certificate prepared: Yes \_\_\_\_\_ No \_\_\_\_\_

Filed in county records at \_\_\_\_\_ Date \_\_\_\_\_ County Document No. \_\_\_\_\_

Identified on aerial photo No. \_\_\_\_\_ Which is filed at \_\_\_\_\_

Index No. P-7  
(Alphabetical - Numerical)LAND CORNER RECORD  
(RECTANGULAR SURVEYS)

RS-5680-11 (5/12/81)

T. 145 R. 25 Mer. N.F. Chippewa County Cass State Minnesota  
1/4 Corner common to sections 20 and

## EXISTING SURVEYS

## Original Government Survey

Year surveyed \_\_\_\_\_

Original monument \_\_\_\_\_  
(Wood post, stone, pile of stones, pipe, etc.)

## Bearing Trees

Species \_\_\_\_\_

Diameter \_\_\_\_\_

Bearing \_\_\_\_\_

Distance \_\_\_\_\_

## Original Evidence Found

Year of search \_\_\_\_\_ By \_\_\_\_\_

Monument found \_\_\_\_\_

## Original Bearing Trees Found

Species \_\_\_\_\_

Diameter \_\_\_\_\_

Bearing \_\_\_\_\_

Distance \_\_\_\_\_

## Subsequent Corner Restoration

Year surveyed \_\_\_\_\_ By \_\_\_\_\_

Where filed or recorded \_\_\_\_\_

Monument \_\_\_\_\_  
(Original, concrete post, iron rod, etc.)

## Bearing Trees, Reference Objects

Species \_\_\_\_\_

Diameter \_\_\_\_\_

Bearing \_\_\_\_\_

Distance \_\_\_\_\_

## Evidence of Subsequent Corner Restoration Found

Year of search 12-9-65 By A. Morrison & D. MorganTag on N. side of 9" Gas pipe - Approx.Corner lies 1.7 ch. N. of tag in meadow.Blue line faintest S. 1/4 E. This approx.corner established by compare &chaining from 1/4 corner 1/2 mi. S.

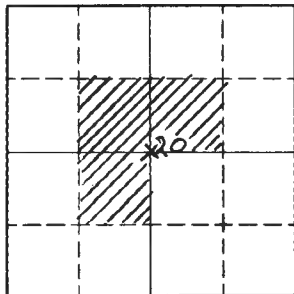

Sketch

○ Corner    ▨ F.S. Land

Relation of Evidence to Record Features Along Section Lines

Section line to sections \_\_\_\_\_  
 Object \_\_\_\_\_  
 Record distance \_\_\_\_\_  
 Measured distance \_\_\_\_\_

Other Evidence

Describe evidence of use and occupation such as roads, fences, clearings, timber cutting lines, plantations, etc.. Cite source of testimony if any. \_\_\_\_\_

At time of search:

1. Did you have the record description?

Yes \_\_\_\_\_ No

2. How was search area located?

Posting, chaining, photos, maps, etc. \_\_\_\_\_

3. Man hours spent in search 1

4. Do you think additional search might recover evidence? Yes \_\_\_\_\_ No

5. Signature *L. Morrison*

Perpetuation Record

Monument and accessories established. Include brief description of area. \_\_\_\_\_

Certified corner restoration certificate prepared: Yes \_\_\_\_\_ No \_\_\_\_\_

Filed in county records at \_\_\_\_\_ Date \_\_\_\_\_ County Document No. \_\_\_\_\_

Identified on aerial photo No. \_\_\_\_\_ Which is filed of \_\_\_\_\_



Index No. P-7  
(Alphabetical - Numerical)

LAND CORNER RECORD  
(RECTANGULAR SURVEYS)

RD-7 150-4 (Rev. 6/13/67)  
GPO 802-127

T. 145 R. 28 S. 5 Mer. N.F. CHIPPEWA County CASS State MN.  
CENTER QUARTER Corner common to sections \_\_\_\_\_ and 20

EXISTING SURVEYS

Original Government Survey

Year surveyed \_\_\_\_\_  
Original monument \_\_\_\_\_  
(Wood post, stone, pile of stones, pipe, etc.)

Bearing Trees

Species \_\_\_\_\_  
Diameter \_\_\_\_\_  
Bearing \_\_\_\_\_  
Distance \_\_\_\_\_

Subsequent Corner Restoration

Year surveyed 5-12-37 By J. A. GJELHAUG  
Where filed or recorded OLD CCC BK #88 Pg. 43  
Monument SET ASPEN POST 3" X 4'  
(Original, concrete post, iron rod, etc.)

MAK NEW BT

Bearing Trees, Reference Objects

Species J. PINE  
Diameter 4  
Bearing S 50E  
Distance 40 LKS.  
26.4'

Original Evidence Found

Year of search \_\_\_\_\_ By \_\_\_\_\_  
Monument found \_\_\_\_\_

Original Bearing Trees Found

Species \_\_\_\_\_  
Diameter \_\_\_\_\_  
Bearing \_\_\_\_\_  
Distance \_\_\_\_\_

Evidence of Subsequent Corner Restoration Found

Year of search \_\_\_\_\_ By \_\_\_\_\_  
\_\_\_\_\_  
\_\_\_\_\_  
\_\_\_\_\_

Bearing Trees, Reference Objects

\_\_\_\_\_  
\_\_\_\_\_  
\_\_\_\_\_  
\_\_\_\_\_

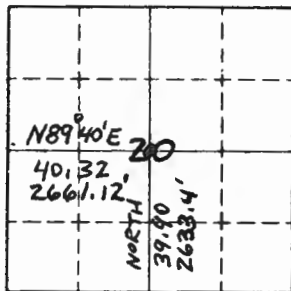

Sketch

Corner  F.S. Land

Relation of Evidence to Record Features Along Section Lines

Section line to sections \_\_\_\_\_  
 Object \_\_\_\_\_  
 Record distance \_\_\_\_\_  
 Measured distance \_\_\_\_\_

Other Evidence

Describe evidence of use and occupation such as roads, fences, clearings, timber cutting lines, plantations, etc.. Cite source of testimony if any. \_\_\_\_\_  
 \_\_\_\_\_  
 \_\_\_\_\_  
 \_\_\_\_\_  
 \_\_\_\_\_

At time of search:

1. Did you have the record description?

Yes \_\_\_\_\_ No \_\_\_\_\_

2. How was search area located?

Pacing, chaining, photos, maps,  
 etc. \_\_\_\_\_  
 \_\_\_\_\_

3. Man hours spent in search \_\_\_\_\_

4. Do you think additional search might  
 recover evidence? Yes \_\_\_\_\_ No \_\_\_\_\_

5. Signature \_\_\_\_\_

Perpetuation Record

Monument and accessories established. Include brief description of area. \_\_\_\_\_  
 \_\_\_\_\_  
 \_\_\_\_\_  
 \_\_\_\_\_  
 \_\_\_\_\_

Certified corner restoration certificate prepared: Yes \_\_\_\_\_ No \_\_\_\_\_

Filed in county records at \_\_\_\_\_ Date \_\_\_\_\_ County Document No. \_\_\_\_\_

Identified on aerial photo No. \_\_\_\_\_ Which is filed at \_\_\_\_\_

T. 145 R. 28 5a Mer. N.F. Chippewa County Cass State Minnesota  
1/4 Corner common to sections 5W 14, 19 and

EXISTING SURVEYS

Original Government Survey	Original Evidence Found
Year surveyed _____ Original monument _____ <small>(Wood post, stone, pile of stones, pipe, etc.)</small>	Year of search _____ By _____ Monument found _____
<p style="text-align: center;">Bearing Trees</p> Species _____ Diameter _____ Bearing _____ Distance _____	<p style="text-align: center;">Original Bearing Trees Found</p> Species _____ Diameter _____ Bearing _____ Distance _____
Subsequent Corner Restoration	Evidence of Subsequent Corner Restoration Found
Year surveyed _____ By _____ Where filed or recorded _____ Monument _____ <small>(Original, concrete post, iron rod, etc.)</small> <p style="text-align: center;">Bearing Trees, Reference Objects</p> Species _____ Diameter _____ Bearing _____ Distance _____	Year of search <u>7-7-64</u> By <u>Moyison &amp; Morgan</u> <u>Tag on <del>the</del><sup>S</sup> side of <del>the</del><sup>12" dia</sup> pine - blue</u> <u>line painted east from corner.</u> <u>black line S. from corner. Approx</u> <u>corner lies <del>1/4</del> tag. 16' dia</u> <u>N. 9° 43' of tag. It is 21.9' ch.</u> <u>S. to 1/16' extension from line.</u>

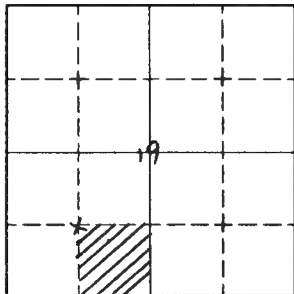

Sketch

○ Corner    ▨ F.S. Land

Relation of Evidence to Record Features Along Section Lines

Section line to sections \_\_\_\_\_  
 Object \_\_\_\_\_  
 Record distance \_\_\_\_\_  
 Measured distance \_\_\_\_\_

Other Evidence

Describe evidence of use and occupation such as roads, fences, clearings, timber cutting lines, plantations, etc.. Cite source of testimony if any. \_\_\_\_\_  
 \_\_\_\_\_  
 \_\_\_\_\_  
 \_\_\_\_\_  
 \_\_\_\_\_

At time of search:

1. Did you have the record description?

Yes \_\_\_ No

2. How was search area located?

Pacing, chaining, ~~photos~~, maps, etc. \_\_\_\_\_  
 \_\_\_\_\_

3. Man hours spent in search 1

4. Do you think additional search might recover evidence? Yes \_\_\_ No

\_\_\_\_\_

5. Signature S. Morrison

Perpetuation Record

Monument and accessories established. Include brief description of area. \_\_\_\_\_  
 \_\_\_\_\_  
 \_\_\_\_\_  
 \_\_\_\_\_  
 \_\_\_\_\_

Certified corner restoration certificate prepared: Yes \_\_\_ No \_\_\_

Filed in county records at \_\_\_\_\_ Date \_\_\_\_\_ County Document No. \_\_\_\_\_

Identified on aerial photo No. \_\_\_\_\_ Which is filed at \_\_\_\_\_

T. 145 R. 28 Mer. N.F. Chippewa County Cass State Minnesota  
S 1/16 Corner common to sections 19 and \_\_\_\_\_

EXISTING SURVEYS

Original Government Survey	Original Evidence Found
Year surveyed _____ Original monument _____ <small>(Wood post, stone, pile of stones, pipe, etc.)</small>	Year of search _____ By _____ Monument found _____
<p style="text-align: center;">Bearing Trees</p> Species _____ Diameter _____ Bearing _____ Distance _____	<p style="text-align: center;">Original Bearing Trees Found</p> Species _____ Diameter _____ Bearing _____ Distance _____
Subsequent Corner Restoration	Evidence of Subsequent Corner Restoration Found
Year surveyed _____ By _____ Where filed or recorded _____ Monument _____ <small>(Original, concrete post, iron rod, etc.)</small>  <p style="text-align: center;">Bearing Trees, Reference Objects</p> Species _____ Diameter _____ Bearing _____ Distance _____	Year of search <u>8-16-64</u> By <u>Morrison &amp; Tucker</u> <u>lay on S. side of 6" aspen. Blue</u> <u>line painted N.E.S. 720 Iron Caps</u> <u>on B.T.'s. Corner established</u> <u>approx by Compass &amp; Chaining</u> <u>from approx Corners to E &amp; W.</u>

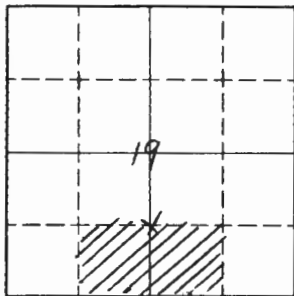

Sketch

○ Corner    ▨ F.S. Land

Relation of Evidence to Record Features Along Section Lines

Section line to sections \_\_\_\_\_  
 Object \_\_\_\_\_  
 Record distance \_\_\_\_\_  
 Measured distance \_\_\_\_\_

Other Evidence

Describe evidence of use and occupation such as roads, fences, clearings, timber cutting lines, plantations, etc.. Cite source of testimony if any. \_\_\_\_\_  
 \_\_\_\_\_  
 \_\_\_\_\_  
 \_\_\_\_\_  
 \_\_\_\_\_

At time of search:

1. Did you have the record description?

Yes \_\_\_\_\_ No

2. How was search area located?

Peering, chaining, photos, maps,  
 etc. \_\_\_\_\_  
 \_\_\_\_\_

3. Man hours spent in search 3

4. Do you think additional search might  
 recover evidence? Yes \_\_\_\_\_ No

5. Signature L.M. Morrison

Perpetuation Record

Monument and accessories established. Include brief description of area. \_\_\_\_\_  
 \_\_\_\_\_  
 \_\_\_\_\_  
 \_\_\_\_\_  
 \_\_\_\_\_

Certified corner restoration certificate prepared: Yes \_\_\_\_\_ No \_\_\_\_\_

Filed in county records at \_\_\_\_\_ Date \_\_\_\_\_ County Document No. \_\_\_\_\_

Identified on aerial photo No. \_\_\_\_\_ Which is filed at \_\_\_\_\_

T. 145 R. 28 5<sup>th</sup> Mer. N.F. Chippewa County Cass State Minnesota  
1/16 Corner common to sections SE 14 15 and

EXISTING SURVEYS

Original Government Survey	Original Evidence Found
Year surveyed _____ Original monument _____ <small>(Wood post, stone, pile of stones, pipe, etc.)</small>	Year of search _____ By _____ Monument found _____
<p style="text-align: center;">Bearing Trees</p> Species _____ Diameter _____ Bearing _____ Distance _____	<p style="text-align: center;">Original Bearing Trees Found</p> Species _____ Diameter _____ Bearing _____ Distance _____
Subsequent Corner Restoration	Evidence of Subsequent Corner Restoration Found
Year surveyed _____ By _____ Where filed or recorded _____ Monument _____ <small>(Original, concrete post, iron rod, etc.)</small> <p style="text-align: center;">Bearing Trees, Reference Objects</p> Species _____ Diameter _____ Bearing _____ Distance _____	Year of search <u>8-16-64</u> By <u>Morrison &amp; Tucker</u> <u>lay on S. side of 6" J. Pine and is</u> <u>at approx Corner. Blue line painted</u> <u>E &amp; W. No brass caps B.T's. Approx</u> <u>Corner established by Morrison</u> <u>&amp; Tucker by Compass &amp; Chaining</u> <u>from approx Corner to E &amp; W.</u>

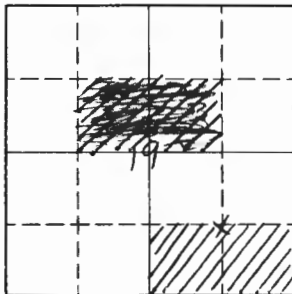

Sketch

○ Corner    ▨ F.S. Land

Relation of Evidence to Record Features Along Section Lines

Section line to sections \_\_\_\_\_  
Object \_\_\_\_\_  
Record distance \_\_\_\_\_  
Measured distance \_\_\_\_\_

Other Evidence

Describe evidence of use and occupation such as roads, fences, clearings, timber cutting lines, plantations, etc.. Cite source of testimony if any. \_\_\_\_\_  
\_\_\_\_\_  
\_\_\_\_\_  
\_\_\_\_\_

At time of search:

1. Did you have the record description?

Yes \_\_\_\_\_ No

2. How was search area located?

~~Recon~~, chaining, photos, maps,  
etc. \_\_\_\_\_  
\_\_\_\_\_

3. Man hours spent in search 2

4. Do you think additional search might  
recover evidence? Yes \_\_\_\_\_ No

5. Signature J. M. Morrison

Perpetuation Record

Monument and accessories established. Include brief description of area. \_\_\_\_\_  
\_\_\_\_\_  
\_\_\_\_\_  
\_\_\_\_\_

Certified corner restoration certificate prepared: Yes \_\_\_\_\_ No \_\_\_\_\_

Filed in county records at \_\_\_\_\_ Date \_\_\_\_\_ County Document No. \_\_\_\_\_

Identified on aerial photo No. \_\_\_\_\_ Which is filed at \_\_\_\_\_



T. 145 R. 28 5<sup>th</sup> Mer. N.F. Chippewa County Cass State Minnesota  
5 1/16 Corner common to sections 19, 20, and

EXISTING SURVEYS

Original Government Survey	Original Evidence Found
Year surveyed _____ Original monument _____ <small>(Wood post, stone, pile of stones, pipe, etc.)</small>	Year of search _____ By _____ Monument found _____
<p style="text-align: center;">Bearing Trees</p> Species _____ Diameter _____ Bearing _____ Distance _____	<p style="text-align: center;">Original Bearing Trees Found</p> Species _____ Diameter _____ Bearing _____ Distance _____
Subsequent Corner Restoration	Evidence of Subsequent Corner Restoration Found
Year surveyed _____ By _____ Where filed or recorded _____ Monument _____ <small>(Original, concrete post, iron rod, etc.)</small>	Year of search <u>7-7-64</u> By <u>Morrison &amp; Morgan</u> <u>tag on S. side of 10" Pine approx</u> <u>corner 16 ft S of tag. blue line</u> <u>marked N, S. + W of corner. no</u> <u>iron caps or B.T's.</u>
<p style="text-align: center;">Bearing Trees, Reference Objects</p> Species _____ Diameter _____ Bearing _____ Distance _____	

*copy to S.O.*

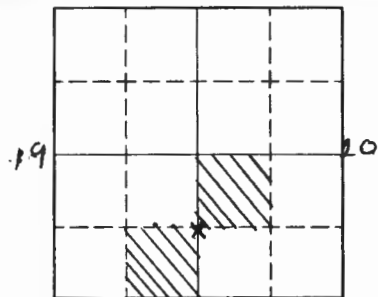

Sketch

○ Corner    ▨ F.S. Land

Relation of Evidence to Record Features Along Section Lines

Section line to sections \_\_\_\_\_  
 Object \_\_\_\_\_  
 Record distance \_\_\_\_\_  
 Measured distance \_\_\_\_\_

Other Evidence

Describe evidence of use and occupation such as roads, fences, clearings, timber cutting lines, plantations, etc.. Cite source of testimony if any. \_\_\_\_\_

At time of search:

1. Did you have the record description?

Yes \_\_\_\_\_ No

2. How was search area located?

~~Placing~~, chaining, ~~photos~~, maps, etc. \_\_\_\_\_

3. Man hours spent in search 1

4. Do you think additional search might recover evidence? Yes \_\_\_\_\_ No

5. Signature S. M. Morrison

Perpetuation Record

Monument and accessories established. Include brief description of area. \_\_\_\_\_

Certified corner restoration certificate prepared: Yes \_\_\_\_\_ No \_\_\_\_\_

Filed in county records at \_\_\_\_\_ Date \_\_\_\_\_ County Document No. \_\_\_\_\_

Identified on aerial photo No. \_\_\_\_\_ Which is filed at \_\_\_\_\_

Index No. Q-7  
(Alphabetical - Numerical)

LAND CORNER RECORD  
(RECTANGULAR SURVEYS)

RS-5880-11 (5/12/84)

T. 145 R. 28 Mer. N.F. 5<sup>th</sup> Chippewa County Casa State Missouri  
Corner common to sections 20 and  
Section 16  
SOUTH

EXISTING SURVEYS

Original Government Survey	Original Evidence Found
Year surveyed _____	Year of search _____ By _____
Original monument _____ <small>(Wood post, stone, pile of stones, pipe, etc.)</small>	Monument found _____
<b>Bearing Trees</b>	<b>Original Bearing Trees Found</b>
Species _____	Species _____
Diameter _____	Diameter _____
Bearing _____	Bearing _____
Distance _____	Distance _____

Subsequent Corner Restoration	Evidence of Subsequent Corner Restoration Found
Year surveyed _____ By _____	Year of search <u>12-9-65</u> By <u>S. Morrison &amp; D. Morgan</u>
Where filed or recorded _____	<u>Tag on W. side of 8" Birch - approx</u>
Monument _____ <small>(Original, concrete post, iron rod, etc.)</small>	<u>corner lies 40 ft N. of Tag - No brass</u>
	<u>cap or B.T.s. This approx. corner</u>
	<u>established by compass &amp; chaining</u>
	<u>from 14 corner 1/4 mi. S-</u>
<b>Bearing Trees, Reference Objects</b>	
Species _____	
Diameter _____	
Bearing _____	
Distance _____	

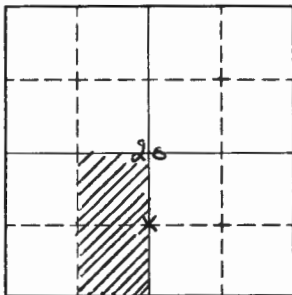

Sketch

○ Corner    ▨ F.S. Land

Relation of Evidence to Record Features Along Section Lines

Section line to sections \_\_\_\_\_  
 Object \_\_\_\_\_  
 Record distance \_\_\_\_\_  
 Measured distance \_\_\_\_\_

Other Evidence

Describe evidence of use and occupation such as roads, fences, clearings, timber cutting lines, plantations, etc.. Cite source of testimony if any. \_\_\_\_\_  
 \_\_\_\_\_  
 \_\_\_\_\_  
 \_\_\_\_\_  
 \_\_\_\_\_

At time of search:

1. Did you have the record description?

Yes \_\_\_\_\_ No

2. How was search area located?

~~Records~~, chaining, photos, maps, etc. \_\_\_\_\_  
 \_\_\_\_\_

3. Man hours spent in search 1

4. Do you think additional search might recover evidence? Yes \_\_\_\_\_ No

5. Signature J. Morrison

Perpetuation Record

Monument and accessories established. Include brief description of area. \_\_\_\_\_  
 \_\_\_\_\_  
 \_\_\_\_\_  
 \_\_\_\_\_  
 \_\_\_\_\_

Certified corner restoration certificate prepared: Yes \_\_\_\_\_ No \_\_\_\_\_

Filed in county records at \_\_\_\_\_ Date \_\_\_\_\_ County Document No. \_\_\_\_\_

Identified on aerial photo No. \_\_\_\_\_ Which is filed at \_\_\_\_\_

Index No. Q-9  
(Alphabetical - Numerical)

LAND CORNER RECORD  
(RECTANGULAR SURVEYS)

RS-5880-11 (5/12/84)

T. 145 R. 28 5<sup>th</sup> Mer. N.F. Chippewa County Cass State Minnesota  
1/4 Corner common to sections \_\_\_\_\_, \_\_\_\_\_, 20 and 31

EXISTING SURVEYS

**Original Government Survey**

Year surveyed \_\_\_\_\_ By \_\_\_\_\_

Original monument \_\_\_\_\_  
(Wood post, stone, pile of stones, pipe, etc.)

**Bearing Trees**

Species \_\_\_\_\_

Diameter \_\_\_\_\_

Bearing \_\_\_\_\_

Distance \_\_\_\_\_

**Original Evidence Found**

Year of search \_\_\_\_\_ By \_\_\_\_\_

Monument found \_\_\_\_\_

**Original Bearing Trees Found**

Species \_\_\_\_\_

Diameter \_\_\_\_\_

Bearing \_\_\_\_\_

Distance \_\_\_\_\_

**Subsequent Corner Restoration**

Year surveyed \_\_\_\_\_ By \_\_\_\_\_

Where filed or recorded \_\_\_\_\_

Monument \_\_\_\_\_  
(Original, concrete post, iron rod, etc.)

**Bearing Trees, Reference Objects**

Species \_\_\_\_\_

Diameter \_\_\_\_\_

Bearing \_\_\_\_\_

Distance \_\_\_\_\_

**Evidence of Subsequent Corners Restoration Found**

Year of search 12-6-65 By S. Morrison & O. Stangel  
Tag on S. side of 5<sup>th</sup> Red Pine - Blue  
line painted S. & E. of corner - No brass  
cap or B.T.s - This approx. corner  
established by compass & chaining from  
approx. Sec. corner 1/4 mi. S. and by  
correlation with old blazed lines,  
another tag on Firway 12 ch. S.

Relation of Evidence to Record Features Along Section Lines

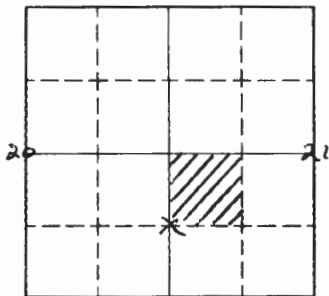

Sketch

○ Corner    ▨ F.S. Land

Section line to sections \_\_\_\_\_  
 Object \_\_\_\_\_  
 Record distance \_\_\_\_\_  
 Measured distance \_\_\_\_\_

Other Evidence

Describe evidence of use and occupation such as roads, fences, clearings, timber cutting lines, plantations, etc.. Cite source of testimony if any. \_\_\_\_\_

At time of search:

1. Did you have the record description?

Yes \_\_\_\_\_ No

2. How was search area located?

~~Placing~~, chaining, photos, maps, etc.

3. Man hours spent in search 1

4. Do you think additional search might recover evidence? Yes \_\_\_\_\_ No

5. Signature J. Morrison

Perpetuation Record

Monument and accessories established. Include brief description of area. \_\_\_\_\_

Certified corner restoration certificate prepared: Yes \_\_\_\_\_ No \_\_\_\_\_

Filed in county records at \_\_\_\_\_ Date \_\_\_\_\_ County Document No. \_\_\_\_\_

Identified on aerial photo No. \_\_\_\_\_ Which is filed at \_\_\_\_\_

Index No. Q-16  
(Alphabetical - Numerical)LAND CORNER RECORD  
(RECTANGULAR SURVEYS)

RS-5680-11 (5/12/64)

T. 145 R. 285<sup>th</sup>Mer. N.F. ChippewaCounty CassState MinnesotaCorner common to sections 21

and

## EXISTING SURVEYS

## Original Government Survey

Year surveyed \_\_\_\_\_

Original monument \_\_\_\_\_  
(Wood post, stone, pile of stones, pipe, etc.)

## Bearing Trees

Species \_\_\_\_\_

Diameter \_\_\_\_\_

Bearing \_\_\_\_\_

Distance \_\_\_\_\_

## Original Evidence Found

Year of search \_\_\_\_\_ By \_\_\_\_\_

Monument found \_\_\_\_\_

## Original Bearing Trees Found

Species \_\_\_\_\_

Diameter \_\_\_\_\_

Bearing \_\_\_\_\_

Distance \_\_\_\_\_

## Subsequent Corner Restoration

Year surveyed \_\_\_\_\_ By \_\_\_\_\_

Where filed or recorded \_\_\_\_\_

Monument \_\_\_\_\_  
(Original, concrete post, iron rod, etc.)

## Bearing Trees, Reference Objects

Species \_\_\_\_\_

Diameter \_\_\_\_\_

Bearing \_\_\_\_\_

Distance \_\_\_\_\_

## Evidence of Subsequent Corner Restoration Found

Year of search 12-6-65 By Schirmer & O. StengelTag on S. side of 8" Birch - approx.  
corner lies 10 ft S.E. of tag. Blue  
line painted E. & W. of corner -  
No brass cap or B. Tag. This approx.  
corner established by compass &  
chaining from approx 7/8 corner  
1/4 mi. W.

Relation of Evidence to Record Features Along Section Lines

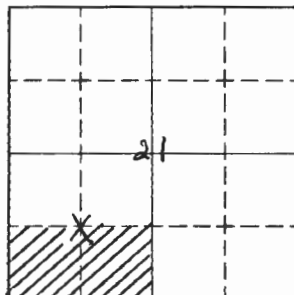

Sketch

○ Corner    ▨ F.S. Land

Section line to sections \_\_\_\_\_  
 Object \_\_\_\_\_  
 Record distance \_\_\_\_\_  
 Measured distance \_\_\_\_\_

Other Evidence

Describe evidence of use and occupation such as roads, fences, clearings, timber cutting lines, plantations, etc.. Cite source of testimony if any. \_\_\_\_\_  
 \_\_\_\_\_  
 \_\_\_\_\_  
 \_\_\_\_\_

At time of search:

1. Did you have the record description?

Yes \_\_\_\_\_ No

2. How was search area located?

~~Placing~~, chaining, photos, maps, etc. \_\_\_\_\_  
 \_\_\_\_\_

3. Man hours spent in search 1

4. Do you think additional search might recover evidence? Yes \_\_\_\_\_ No

5. Signature S. Morrison

Perpetuation Record

Monument and accessories established. Include brief description of area. \_\_\_\_\_  
 \_\_\_\_\_  
 \_\_\_\_\_  
 \_\_\_\_\_

Certified corner restoration certificate prepared: Yes \_\_\_\_\_ No \_\_\_\_\_

Filed in county records at \_\_\_\_\_ Date \_\_\_\_\_ County Document No. \_\_\_\_\_

Identified on aerial photo No. \_\_\_\_\_ Which is filed at \_\_\_\_\_





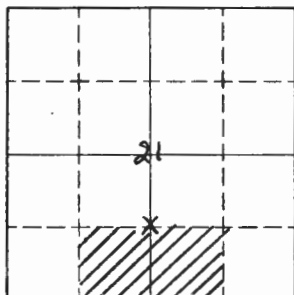

Sketch

○ Corner    ▨ F.S. Land

Relation of Evidence to Record Features Along Section Lines

Section line to sections \_\_\_\_\_  
 Object \_\_\_\_\_  
 Record distance \_\_\_\_\_  
 Measured distance \_\_\_\_\_

Other Evidence

Describe evidence of use and occupation such as roads, fences, clearings, timber cutting lines, plantations, etc.. Cite source of testimony if any. \_\_\_\_\_  
 \_\_\_\_\_  
 \_\_\_\_\_

At time of search:

1. Did you have the record description?

Yes \_\_\_\_\_ No

2. How was search area located?

~~Plats~~, chaining, ~~photos~~, maps,  
 etc. \_\_\_\_\_

3. Man hours spent in search 1

4. Do you think additional search might  
 recover evidence? Yes \_\_\_\_\_ No

5. Signature S. Morrison

Perpetuation Record

Monument and accessories established. include brief description of area. \_\_\_\_\_  
 \_\_\_\_\_  
 \_\_\_\_\_

Certified corner restoration certificate prepared: Yes \_\_\_\_\_ No \_\_\_\_\_  
 Filed in county records at \_\_\_\_\_ Date \_\_\_\_\_ County Document No. \_\_\_\_\_  
 Identified on aerial photo No. \_\_\_\_\_ Which is filed at \_\_\_\_\_

Indr. No. R-1  
(Alphabetical - Numerical)

Book # 1  
 PAGE # 11

LAND CORNER RECORD  
(RECTANGULAR SURVEYS)

2 of 2

R9-7150-4 (Rev. 6/13/67)  
 GPO 508-127

To 145 N. R. 28 W.  
SECTION

5TH

Mer. N.F. CHIPPENWA

County CASS

State MO

Corner common to sections 19

24

30

and 25

EXISTING SURVEYS

Original Government Survey

Year surveyed 1873

Original monument

(Wood post, stone, pile of stones, pipe, etc.)

Bearing Trees

Species	<u>N. Pine</u>	<u>N. Pine</u>	<u>N. Pine</u>	<u>N. Pine</u>
Diameter	<u>20"</u>	<u>24"</u>	<u>18"</u>	<u>16"</u>
Bearing	<u>N74°W</u>	<u>N52°E</u>	<u>S88°W</u>	<u>S75°E</u>
Distance	<u>61.60'</u>	<u>105.60'</u>	<u>16.50'</u>	<u>39.28'</u>

Original Evidence Found

Year of search 1928 By CCC

Monument found

5x5x24" Squared scribed wood post. Post on Hi. way approx. 33.00' SW of cor.

Original Bearing Trees Found

Species	<u>NO B. T's Found</u>
Diameter	
Bearing	
Distance	

Subsequent Corner Restoration

Year surveyed 8/68 By Oberman

Where filed or recorded U.S.F.S. Book #1 Page #11

Monument 6" x 24" long cylindrical concrete

(Originally concrete, metal, iron rod, etc.)

monument w/ 3" brass tablet.

7145N  
R29W R20W  
S24 S19  
S29 S30  
1460  
N65 N6680'

Bearing Trees, Reference Objects

Species	<u>Jr. Pine</u>	<u>R. Oak</u>	<u>R. Oak</u>	<u>R. Pine</u>
Diameter	<u>10"</u>	<u>8"</u>	<u>9"</u>	<u>21"</u>
Bearing	<u>N55°E</u>	<u>S40°E</u>	<u>S36°W</u>	<u>N46°W</u>
Distance	<u>155.95'</u>	<u>134.84'</u>	<u>101.90'</u>	<u>197.95'</u>
Scribed	<u>S19 BT</u>	<u>S30 BT</u>	<u>S25 BT</u>	<u>S24 BT</u>

Evidence of Subsequent Corner Restoration Found

Year of search \_\_\_\_\_ By \_\_\_\_\_

Bearing Trees, Reference Objects

Species				
Diameter				
Bearing				
Distance				
Scribed				

Relation of Evidence to Record Features Along Section Lines

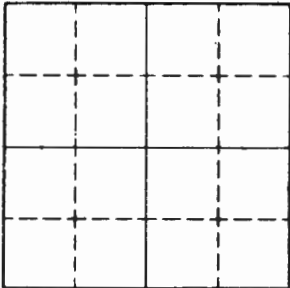

Sketch

O Corner  F.S. Land

Section line to sections \_\_\_\_\_

Object \_\_\_\_\_

Record distance \_\_\_\_\_

Measured distance \_\_\_\_\_

Other Evidence

Describe evidence of use and occupation such as roads, fences, clearings, timber cutting lines, plantations, etc.. Cite source of testimony if any. \_\_\_\_\_

At time of search:

1. Did you have the record description?

Yes \_\_\_\_\_ No \_\_\_\_\_

2. How was search area located?

Pacing, chaining, photos, maps, etc. \_\_\_\_\_

3. Man hours spent in search \_\_\_\_\_

4. Do you think additional search might recover evidence? Yes \_\_\_\_\_ No \_\_\_\_\_

Perpetuation Record

Monument and accessories established. Include brief description of area. \_\_\_\_\_

Certified corner restoration certificate prepared: Yes \_\_\_\_\_ No

Filed in county records at \_\_\_\_\_ Date \_\_\_\_\_ County Document No. \_\_\_\_\_

Identified on aerial photo No. \_\_\_\_\_ Which is filed at \_\_\_\_\_

5. Signature *MC Hayes, extended from field book*

T. 145 R. 28 5a Mer. N.F. Chippewa County Casa State Minnesota  
Section Corner common to sections 19 & 30 and

EXISTING SURVEYS	
Original Government Survey	Original Evidence Found
Year surveyed _____	Year of search _____ By _____
Original monument _____ <small>(Wood post, stone, pile of stones, pipe, etc.)</small>	Monument found _____
<b>Bearing Trees</b>	<b>Original Bearing Trees Found</b>
Species _____	Species _____
Diameter _____	Diameter _____
Bearing _____	Bearing _____
Distance _____	Distance _____
Subsequent Corner Restoration	Evidence of Subsequent Corner Restoration Found
Year surveyed _____ By _____	Year of search <u>8-13-64</u> By <u>Morrison B. Tucker</u>
Where filed or recorded _____	Corner <u>Consists of a square post with</u>
Monument _____ <small>(Original, concrete post, iron rod, etc.)</small>	<u>a corner attached which lies on south</u>
_____	<u>side of Highway #2 and is visible from</u>
_____	<u>Highway. Blue line painted N. of</u>
_____	<u>Corner. Approx. Corner established by</u>
<b>Bearing Trees, Reference Objects</b>	<u>Compass &amp; Chaining from Sec Corner 1 mile</u>
Species _____	<u>N. which is a brass cap &amp; from following</u>
Diameter _____	<u>a cut-out line (1 mile E) starting at brass cap.</u>
Bearing _____	<u>This is where the 2 lines intersect. The</u>
Distance _____	<u>measured distance to brass cap to the N. is</u>
<u>divided evenly between the "40 a" to the N.</u>	<u>90.35 chains. The other 10.35 chains are</u>

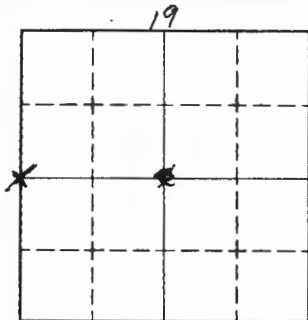

30  
Sketch

○ Corner    ▨ F.S. Land

Relation of Evidence to Record Features Along Section Lines

R-1

Section line to sections \_\_\_\_\_  
 Object \_\_\_\_\_  
 Record distance \_\_\_\_\_  
 Measured distance \_\_\_\_\_

Other Evidence

Describe evidence of use and occupation such as roads, fences, clearings, timber cutting lines, plantations, etc.. Cite source of testimony if any. \_\_\_\_\_  
 \_\_\_\_\_  
 \_\_\_\_\_  
 \_\_\_\_\_  
 \_\_\_\_\_

At time of search:

1. Did you have the record description?

Yes \_\_\_\_\_ No

2. How was search area located?

Pacing, chaining, photos, maps,  
 etc. \_\_\_\_\_  
 \_\_\_\_\_

3. Mon hours spent in search 2

4. Do you think additional search might  
 recover evidence? Yes \_\_\_\_\_ No

5. Signature J. M. Moran

Perpetuation Record

Monument and accessories established. Include brief description of area. \_\_\_\_\_  
 \_\_\_\_\_  
 \_\_\_\_\_  
 \_\_\_\_\_  
 \_\_\_\_\_

Certified corner restoration certificate prepared: Yes \_\_\_\_\_ No \_\_\_\_\_

Filed in county records at \_\_\_\_\_ Date \_\_\_\_\_ County Document No. \_\_\_\_\_

Identified on aerial photo No. \_\_\_\_\_ Which is filed at \_\_\_\_\_

T. 145 R. 28 59 Mer. N.F. Chippewa County Cass State Minnesota  
W 1/16 Corner common to sections 19, 30 and

## EXISTING SURVEYS

Original Government Survey	Original Evidence Found
Year surveyed _____ Original monument _____ <small>(Wood post, stone, pile of stones, pipe, etc.)</small>	Year of search _____ By _____ Monument found _____
<p style="text-align: center;">Bearing Trees</p> Species _____ Diameter _____ Bearing _____ Distance _____	<p style="text-align: center;">Original Bearing Trees Found</p> Species _____ Diameter _____ Bearing _____ Distance _____
Subsequent Corner Restoration	Evidence of Subsequent Corner Restoration Found
Year surveyed _____ By _____ Where filed or recorded _____ Monument _____ <small>(Original, concrete post, iron rod, etc.)</small> <p style="text-align: center;">Bearing Trees, Reference Objects</p> Species _____ Diameter _____ Bearing _____ Distance _____	Year of search <u>8-6-64</u> By <u>J.M. Morrison</u> <u>Tag on N.W. side of 12" red pine.</u> <u>Opposite Corner Consists of an iron</u> <u>pipe with a wooden stake inside</u> <u>it which lies 8' W of tag. Another</u> <u>tag on N. side of Hwy #2 lies 1/8</u> <u>chains S. of Corner. Blue line painted</u> <u>E &amp; N of Corner. No brass caps or B.T.'s.</u>

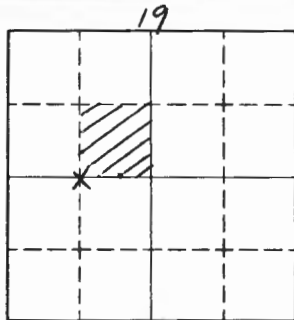

30  
Sketch

○ Corner    ▨ F.S. Land

Relation of Evidence to Record Features Along Section Lines

Section line to sections \_\_\_\_\_  
 Object \_\_\_\_\_  
 Record distance \_\_\_\_\_  
 Measured distance \_\_\_\_\_

Other Evidence

Describe evidence of use and occupation such as roads, fences, clearings, timber cutting lines, plantations, etc.. Cite source of testimony if any. \_\_\_\_\_

\_\_\_\_\_

\_\_\_\_\_

\_\_\_\_\_

\_\_\_\_\_

At time of search:

1. Did you have the record description?

Yes \_\_\_\_\_ No

2. How was search area located?

~~Pacing~~, chaining, photos, maps,  
 etc. \_\_\_\_\_

\_\_\_\_\_

3. Man hours spent in search 1

4. Do you think additional search might  
 recover evidence? Yes \_\_\_\_\_ No

5. Signature S. M. Morrison

Perpetuation Record

Monument and accessories established. Include brief description of area. \_\_\_\_\_

\_\_\_\_\_

\_\_\_\_\_

\_\_\_\_\_

\_\_\_\_\_

Certified corner restoration certificate prepared: Yes \_\_\_\_\_ No \_\_\_\_\_  
 Filed in county records at \_\_\_\_\_ Date \_\_\_\_\_ County Document No. \_\_\_\_\_  
 Identified on aerial photo No. \_\_\_\_\_ Which is filed at \_\_\_\_\_



T. 145 R. 28 114 5<sup>a</sup> Mer. N.F. Chippewa County Cass State Minnesota  
 Corner common to sections 19 & 30 and

EXISTING SURVEYS

Original Government Survey

Year surveyed \_\_\_\_\_  
 Original monument \_\_\_\_\_  
(Wood post, stone, pile of stones, pipe, etc.)

Bearing Trees

Species \_\_\_\_\_  
 Diameter \_\_\_\_\_  
 Bearing \_\_\_\_\_  
 Distance \_\_\_\_\_

Subsequent Corner Restoration

Year surveyed \_\_\_\_\_ By \_\_\_\_\_  
 Where filed or recorded \_\_\_\_\_  
 Monument \_\_\_\_\_  
(Original, concrete post, iron rod, etc.)

Bearing Trees, Reference Objects

Species \_\_\_\_\_  
 Diameter \_\_\_\_\_  
 Bearing \_\_\_\_\_  
 Distance \_\_\_\_\_

Original Evidence Found

Year of search \_\_\_\_\_ By \_\_\_\_\_  
 Monument found \_\_\_\_\_

Original Bearing Trees Found

Species \_\_\_\_\_  
 Diameter \_\_\_\_\_  
 Bearing \_\_\_\_\_  
 Distance \_\_\_\_\_

Evidence of Subsequent Corner Restoration Found

Year of search 7-9-63 By Morrison Walters  
old tag on S.W. side of 11" J.P. Pine new  
tag put upon this same tree.  
Squared stake & iron pipe lies  
13 lbs S.W. of tag. No brass cap on  
B.T.'s. old blaze line runs E. of  
this corner. Bathing Beauty tied to  
Corner stake.

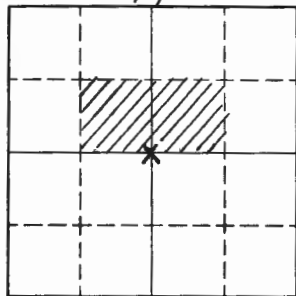

30  
Sketch

○ Corner    ▨ F.S. Land

Relation of Evidence to Record Features Along Section Lines

Section line to sections \_\_\_\_\_  
 Object \_\_\_\_\_  
 Record distance \_\_\_\_\_  
 Measured distance \_\_\_\_\_

Other Evidence

Describe evidence of use and occupation such as roads, fences, clearings, timber cutting lines, plantations, etc.. Cite source of testimony if any. \_\_\_\_\_  
 \_\_\_\_\_  
 \_\_\_\_\_  
 \_\_\_\_\_  
 \_\_\_\_\_

At time of search:

1. Did you have the record description?

Yes \_\_\_\_\_ No

2. How was search area located?

Roading, chaining, photos, maps,  
 etc. \_\_\_\_\_  
 \_\_\_\_\_

3. Man hours spent in search 12

4. Do you think additional search might

recover evidence? Yes \_\_\_\_\_ No

5. Signature S. M. Morrison

Perpetuation Record

Monument and accessories established. Include brief description of area. \_\_\_\_\_  
 \_\_\_\_\_  
 \_\_\_\_\_  
 \_\_\_\_\_  
 \_\_\_\_\_

Certified corner restoration certificate prepared: Yes \_\_\_\_\_ No \_\_\_\_\_

Filed in county records at \_\_\_\_\_ Date \_\_\_\_\_ County Document No. \_\_\_\_\_

Identified on aerial photo No. \_\_\_\_\_ Which is filed at \_\_\_\_\_

T. 145 R. 28 5<sup>th</sup> Mer. N.F. Chippewa County Cass State Minnesota  
E 1/4 Corner common to sections 19 & 30 and

EXISTING SURVEYS

Original Government Survey

Year surveyed \_\_\_\_\_  
 Original monument \_\_\_\_\_  
(Wood post, stone, pile of stones, pipe, etc.)

Bearing Trees

Species \_\_\_\_\_  
 Diameter \_\_\_\_\_  
 Bearing \_\_\_\_\_  
 Distance \_\_\_\_\_

Original Evidence Found

Year of search \_\_\_\_\_ By \_\_\_\_\_  
 Monument found \_\_\_\_\_

Original Bearing Trees Found

Species \_\_\_\_\_  
 Diameter \_\_\_\_\_  
 Bearing \_\_\_\_\_  
 Distance \_\_\_\_\_

Subsequent Corner Restoration

Year surveyed \_\_\_\_\_ By \_\_\_\_\_  
 Where filed or recorded \_\_\_\_\_  
 Monument \_\_\_\_\_  
(Original, concrete post, iron rod, etc.)

Bearing Trees, Reference Objects

Species \_\_\_\_\_  
 Diameter \_\_\_\_\_  
 Bearing \_\_\_\_\_  
 Distance \_\_\_\_\_

Evidence of Subsequent Corner Restoration Found

Year of search 7-9-63 By Thomson & Hatters  
Tag on South side of 9" Jack Pine  
and is close to a fence corner. No  
iron Copor B.T.'s. in evidence. An  
iron pipe is at fence corner, but  
believe the corner lies a few ft. West  
of iron pipe -

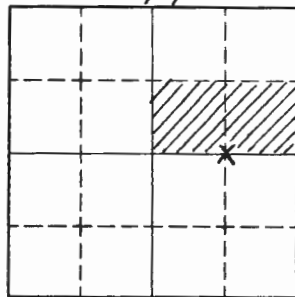

30  
Sketch

○ Corner    ▨ F.S. Land

Relation of Evidence to Record Features Along Section Lines

Section line to sections \_\_\_\_\_  
 Object \_\_\_\_\_  
 Record distance \_\_\_\_\_  
 Measured distance \_\_\_\_\_

Other Evidence

Describe evidence of use and occupation such as roads, fences, clearings, timber cutting lines, plantations, etc.. Cite source of testimony if any. \_\_\_\_\_

Perpetuation Record

Monument and accessories established. Include brief description of area. \_\_\_\_\_

Certified corner restoration certificate prepared:      Yes \_\_\_\_\_ No \_\_\_\_\_

Filed in county records at \_\_\_\_\_ Date \_\_\_\_\_ County Document No. \_\_\_\_\_

Identified on aerial photo No. \_\_\_\_\_ Which is filed at \_\_\_\_\_

At time of search:

1. Did you have the record description?

Yes  No

2. How was search area located?

Pacing, chaining, photos, maps, etc. \_\_\_\_\_

3. Man hours spent in search \_\_\_\_\_

4. Do you think additional search might recover evidence? Yes \_\_\_\_\_ No \_\_\_\_\_

5. Signature \_\_\_\_\_

T. 145 R. 28 Mer. N.F. Chippewa County Cass State Minnesota  
1/4 Corner common to sections 20 and 29

EXISTING SURVEYS	
Original Government Survey	Original Evidence Found
Year surveyed _____	Year of search _____ By _____
Original monument _____ <small>(Wood post, stone, pile of stones, pipe, etc.)</small>	Monument found _____
Bearing Trees	Original Bearing Trees Found
Species _____	Species _____
Diameter _____	Diameter _____
Bearing _____	Bearing _____
Distance _____	Distance _____
Subsequent Corner Restoration	Evidence of Subsequent Corner Restoration Found
Year surveyed _____ By _____	Year of search <u>12-9-65</u> By <u>J. Morrison &amp; D. Morgan</u>
Where filed or recorded _____	Corner consists of <u>old squared slabs</u>
Monument _____ <small>(Original, concrete post, iron rod, etc.)</small>	<u>Top on W. side of Tomcreek, 9" - Corner</u> <u>lies S. 61° W of top 8 ft. - another top on</u> <u>E. side of 11" Tomcreek - corner lies N. 79° E.</u> <u>of top 7 ft. - Old notes of J. A. Bjelhang</u> <u>indicate a B.T. - I think 8" N. 10° E.</u> <u>31 lbs. - There is a blowdown tree at this</u> <u>location but we were unable to tell if it</u> <u>was a B.T. - Believe it would be worthwhile</u> <u>to check again in summer to try &amp; re-establish</u> <u>the corner - Blue line painted N &amp; S.</u>
Bearing Trees, Reference Objects	
Species _____	
Diameter _____	
Bearing _____	
Distance _____	

*copy for S.O.*

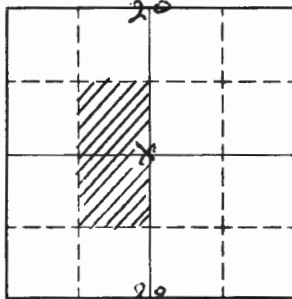

Sketch

○ Corner    ▨ F.S. Land

Relation of Evidence to Record Features Along Section Lines

Section line to sections \_\_\_\_\_  
 Object \_\_\_\_\_  
 Record distance \_\_\_\_\_  
 Measured distance \_\_\_\_\_

Other Evidence

Describe evidence of use and occupation such as roads, fences, clearings, timber cutting lines, plantations, etc.. Cite source of testimony if any. \_\_\_\_\_  
 \_\_\_\_\_  
 \_\_\_\_\_  
 \_\_\_\_\_  
 \_\_\_\_\_

At time of search:

1. Did you have the record description?

Yes  No

2. How was search area located?

~~Pacing~~, chaining, photos, maps,  
 etc. \_\_\_\_\_

3. Man hours spent in search 1

4. Do you think additional search might

recover evidence? Yes  No

5. Signature S. Morrison

Perpetuation Record

Monument and accessories established. Include brief description of area. \_\_\_\_\_  
 \_\_\_\_\_  
 \_\_\_\_\_  
 \_\_\_\_\_  
 \_\_\_\_\_

Certified corner restoration certificate prepared: Yes  No

Filed in county records at \_\_\_\_\_ Date \_\_\_\_\_ County Document No. \_\_\_\_\_

Identified on aerial photo No. \_\_\_\_\_ Which is filed at \_\_\_\_\_

Index No. R-9  
(Alphabetical - Numerical)Book #1  
Page #40LAND CORNER RECORD  
(RECTANGULAR SURVEYS)

RS-5680-11 (5/12/61)

T. 145 R. 28 Mer. N.F. Chippewa County Cass State Minnesota  
Sec. 5<sup>d</sup> Corner common to sections 20, 21, 28 and 29

## EXISTING SURVEYS

## Original Government Survey

Year surveyed \_\_\_\_\_ By \_\_\_\_\_  
Original monument \_\_\_\_\_  
(Wood post, stone, pile of stones, pipe, etc.)

## Bearing Trees

Species \_\_\_\_\_  
Diameter \_\_\_\_\_  
Bearing \_\_\_\_\_  
Distance \_\_\_\_\_

## Subsequent Corner Restoration

Year surveyed \_\_\_\_\_ By \_\_\_\_\_  
Where filed or recorded \_\_\_\_\_  
Monument \_\_\_\_\_  
(Original, concrete post, iron rod, etc.)

## Bearing Trees, Reference Objects

Species \_\_\_\_\_  
Diameter \_\_\_\_\_  
Bearing \_\_\_\_\_  
Distance \_\_\_\_\_

## Original Evidence Found

Year of search \_\_\_\_\_ By \_\_\_\_\_  
Monument found \_\_\_\_\_

## Original Bearing Trees Found

Species \_\_\_\_\_  
Diameter \_\_\_\_\_  
Bearing \_\_\_\_\_  
Distance \_\_\_\_\_

## Evidence of Subsequent Corner Restoration Found

Year of search 12-6-65 By J. Morrison & C. Stengel  
Tag on E. side of 7" J. Pine - also Tbr.  
sale bdy. tag on same tree which is approx  
corner. Blue line painted E. & N.  
from here. Another tag on Fireway 6 ch.  
E. and another one 8 ch. N. on Fireway.  
No cross gap or B.T. This approx  
corner located by compass & chaining  
from approx. corner 1/4 mile E. Tbr. sale  
bdy. marker already in place

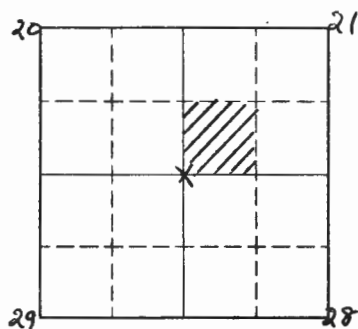

Sketch

○ Corner    ▨ F.S. Land

Relation of Evidence to Record Features Along Section Lines

Section line to sections \_\_\_\_\_  
 Object \_\_\_\_\_  
 Record distance \_\_\_\_\_  
 Measured distance \_\_\_\_\_

Other Evidence

Describe evidence of use and occupation such as roads, fences, clearings, timber cutting lines, plantations, etc.. Cite source of testimony if any. \_\_\_\_\_  
 \_\_\_\_\_  
 \_\_\_\_\_  
 \_\_\_\_\_  
 \_\_\_\_\_

At time of search:

1. Did you have the record description?

Yes \_\_\_\_\_ No

2. How was search area located?

~~Recon~~, chaining, ~~photos~~, maps, etc. \_\_\_\_\_  
 \_\_\_\_\_

3. Man hours spent in search 1

4. Do you think additional search might recover evidence? Yes \_\_\_\_\_ No

5. Signature *J. Morrison*

Perpetuation Record

Monument and accessories established. Include brief description of area. \_\_\_\_\_  
 \_\_\_\_\_  
 \_\_\_\_\_  
 \_\_\_\_\_  
 \_\_\_\_\_

Certified corner restoration certificate prepared: Yes \_\_\_\_\_ No \_\_\_\_\_

Filed in county records of \_\_\_\_\_ Date \_\_\_\_\_ County Document No. \_\_\_\_\_

Identified on aerial photo No. \_\_\_\_\_ Which is filed at \_\_\_\_\_



Index No. R-10  
(Alphabetical - Numerical)LAND CORNER RECORD  
(RECTANGULAR SURVEYS)

RD-5680-11 (5/12/64)

T. 145 R. 28 Mer. N.F. Chippewa County Cass State Minnesota  
1/16 Corner common to sections 21 and 28

## EXISTING SURVEYS

## Original Government Survey

Year surveyed \_\_\_\_\_  
Original monument \_\_\_\_\_  
(Wood post, stone, pile of stones, pipe, etc.)

## Bearing Trees

Species \_\_\_\_\_  
Diameter \_\_\_\_\_  
Bearing \_\_\_\_\_  
Distance \_\_\_\_\_

## Subsequent Corner Restoration

Year surveyed \_\_\_\_\_ By \_\_\_\_\_  
Where filed or recorded \_\_\_\_\_  
Monument \_\_\_\_\_  
(Original, concrete post, iron rod, etc.)

## Bearing Trees, Reference Objects

Species \_\_\_\_\_  
Diameter \_\_\_\_\_  
Bearing \_\_\_\_\_  
Distance \_\_\_\_\_

## Original Evidence Found

Year of search \_\_\_\_\_ By \_\_\_\_\_  
Monument found \_\_\_\_\_

## Original Bearing Trees Found

Species \_\_\_\_\_  
Diameter \_\_\_\_\_  
Bearing \_\_\_\_\_  
Distance \_\_\_\_\_

## Evidence of Subsequent Corner Restoration Found

Year of search 12-6-65 By Sherwin & O. Stengel  
logs on SW side of 6" I Pine  
approx. corner line 14 lbs E. of tag  
No brass cap or B.T. - Blue line  
Painted S. & W. from approx. corner  
Old log was already in place at this  
location - put up in 1957 by  
W. H. Heron - another tag on Highway  
7.23 chs. - S.

Relation of Evidence to Record Features Along Section Lines

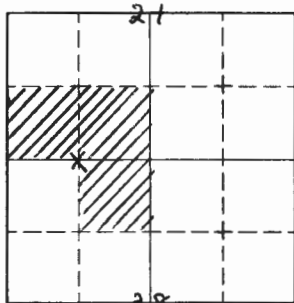

Sketch

○ Corner    ▨ F.S. Land

Section line to sections \_\_\_\_\_  
 Object \_\_\_\_\_  
 Record distance \_\_\_\_\_  
 Measured distance \_\_\_\_\_

Other Evidence

Describe evidence of use and occupation such as roads, fences, clearings, timber cutting lines, plantations, etc.. Cite source of testimony if any. \_\_\_\_\_

At time of search:

1. Did you have the record description?  
 Yes \_\_\_\_\_ No

2. How was search area located?  
~~Racing~~, chaining, ~~plans~~, maps,  
 etc. \_\_\_\_\_

3. Man hours spent in search 1

4. Do you think additional search might  
 recover evidence? Yes \_\_\_\_\_ No

5. Signature *S. Morrison*

Perpetuation Record

Monument and accessories established. Include brief description of area. \_\_\_\_\_

Certified corner restoration certificate prepared: Yes \_\_\_\_\_ No \_\_\_\_\_

Filed in county records at \_\_\_\_\_ Date \_\_\_\_\_ County Document No. \_\_\_\_\_

Identified on aerial photo No. \_\_\_\_\_ Which is filed at \_\_\_\_\_

Index No. B-25  
(Alphabetical - Memorial)

LAND CORNER RECORD  
(RECTANGULAR SURVEYS)

RD-7150-4 (Rev. 6/13/67)

T. 145 R. 28

5th. Mer. N.F.

Chippewa County

Cass State

MN GPO 802-127

Section Corner common to sections 24, 25, 19 and 30

EXISTING SURVEYS

Original Government Survey

Year surveyed \_\_\_\_\_  
Original monument \_\_\_\_\_  
(Wood post, stone, pile of stones, pipe, etc.)

Bearing Trees

Species \_\_\_\_\_  
Diameter \_\_\_\_\_  
Bearing \_\_\_\_\_  
Distance \_\_\_\_\_

Subsequent Corner Restoration

Year surveyed \_\_\_\_\_ By \_\_\_\_\_  
Where filed or recorded \_\_\_\_\_  
Monument \_\_\_\_\_  
(Original, concrete post, brass rod, etc.)

Bearing Trees, Reference Objects

Species Tam. Tam.  
Diameter 8" 10"  
Bearing S.12' W.18'  
Distance \_\_\_\_\_

Original Evidence Found

Year of search \_\_\_\_\_ By \_\_\_\_\_  
Monument found \_\_\_\_\_

Original Bearing Trees Found

Species \_\_\_\_\_  
Diameter \_\_\_\_\_  
Bearing \_\_\_\_\_  
Distance \_\_\_\_\_

Evidence of Subsequent Corner Restoration Found

Year of search 2-13-73 By W.R.T.  
Corner consists of a brass cap. B.T. is a 10"  
Tamarack with a corner tag on the W. side of  
tree. Corner lies SW of B.T. approx. 15'  
from B.T. Blue line painted S.

Bearing Trees, Reference Objects

Species \_\_\_\_\_  
Diameter \_\_\_\_\_  
Bearing \_\_\_\_\_  
Distance \_\_\_\_\_

SC COPY

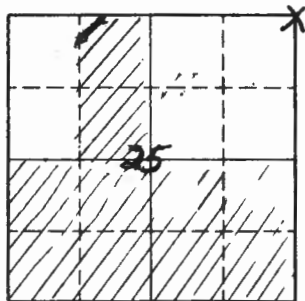

Sketch

O Corner    ▨ F.S. Land

Relation of Evidence to Record Features Along Section Lines

Section line to sections \_\_\_\_\_  
 Object \_\_\_\_\_  
 Record distance \_\_\_\_\_  
 Measured distance \_\_\_\_\_

Other Evidence

Describe evidence of use and occupation such as roads, fences, clearings, timber cutting lines, plantations, etc.. Cite source of testimony if any. \_\_\_\_\_

At time of search:

1. Did you have the record description?

Yes \_\_\_\_\_ No \_\_\_\_\_

2. How was search area located?

Pacing, chaining, photos, maps, etc. \_\_\_\_\_

3. Mon hours spent in search \_\_\_\_\_

4. Do you think additional search might recover evidence? Yes \_\_\_\_\_ No \_\_\_\_\_

5. Signature \_\_\_\_\_

Perpetuation Record

Monument and accessories established. Include brief description of area. \_\_\_\_\_

Certified corner restoration certificate prepared: Yes \_\_\_\_\_ No \_\_\_\_\_

Filed in county records at \_\_\_\_\_ Date \_\_\_\_\_ County Document No. \_\_\_\_\_

Identified on aerial photo No. \_\_\_\_\_ Which is filed at \_\_\_\_\_

Index No. S-2  
(Alphabetical - Numerical)

LAND CORNER RECORD  
(RECTANGULAR SURVEYS)

R9-7150-4 (Rev. 6/13/67)  
GPO 802-127

T. 145 R. 28 S. Mer. N.F. CHIPPEWA County CASS State MN  
NORTH WEST 1/16 Corner common to sections \_\_\_\_\_ and 30

EXISTING SURVEYS

Original Government Survey	Original Evidence Found
Year surveyed _____	Year of search _____ By _____
Original monument _____ <small>(Wood post, stone, pile of stones, pipe, etc.)</small>	Monument found _____
<b>Bearing Trees</b>	<b>Original Bearing Trees Found</b>
Species _____	Species _____
Diameter _____	Diameter _____
Bearing _____	Bearing _____
Distance _____	Distance _____
<b>Subsequent Corner Restoration</b>	<b>Evidence of Subsequent Corner Restoration Found</b>
Year surveyed. <u>8-1938</u> By <u>WELLER</u>	Year of search <u>3-21-95</u> By <u>R. MAIN - C. KRAUSE</u>
Where filed or recorded <u>C.C.C. BK #18 Pg. 30</u>	<u>Fd 1 1/4" X 3" HIGH IRON PIPE - IN PLACE</u>
Monument <u>SET 1/16 COR. #4</u> <small>(Original, concrete post, iron rod, etc.)</small>	<u>Fd. LARGE DEAD J. PINE SNAG w/ BLAZE FACING TO IRON OR ON SE SIDE - SNAG IS N75W-19'± FROM IRON PIPE - ON SIDE SLOPE WITH HEAVY BRUSH - RECENTLY LOGGED NW-N + NE</u>
<u>SET F.S. POSTER ON (W.T.) JACK PINE 18" BRS. N70W - 29 LKS. = 19.14'</u>	
<b>Bearing Trees, Reference Objects</b>	
Species _____	6-5-95 CK Bearing Trees, Reference Objects <u>OVER</u>
Diameter _____	<u>8' S.P. J. PINE STUB 8' S.P. MAPLE</u>
Bearing _____	<u>18" 8</u>
Distance _____	<u>EAST N71W SOUTH 534E</u>
	<u>3.55' 18.55' 3.95' 9.60'</u>
	<u>SPK + TAG FSLP</u>

Relation of Evidence to Record Features Along Section Lines

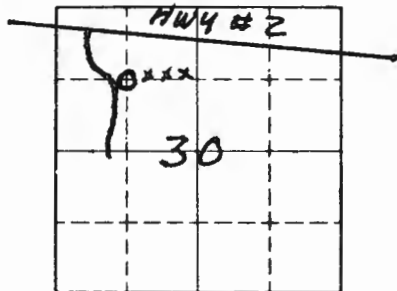

Sketch

○ Corner     F.S. Land

Section line to sections \_\_\_\_\_  
 Object \_\_\_\_\_  
 Record distance \_\_\_\_\_  
 Measured distance \_\_\_\_\_

Other Evidence

Describe evidence of use and occupation such as roads, fences, clearings, timber cutting lines, plantations, etc.. Cite source of testimony if any. \_\_\_\_\_

FD. PLANTATION POST LYING ON GROUND - BROKEN OFF WITH BASE IN PLACE - 3' NE OF IRON OLD FENCE LINE BRS. SBIW + NBIE - FENCE IS 14' NORTH OF IRON PIPE  
GPS THIS POSITION TO SEE HOW IT FITS WITHIN SECTION 30

At time of search:

1. Did you have the record description?

Yes \_\_\_\_\_ No \_\_\_\_\_

2. How was search area located?

Pacing, chaining, photos, maps, etc. \_\_\_\_\_

3. Man hours spent in search \_\_\_\_\_

4. Do you think additional search might recover evidence? Yes \_\_\_\_\_ No \_\_\_\_\_

5. Signature Curt Krause

Perpetuation Record

Monument and accessories established. Include brief description of area. \_\_\_\_\_  
WE HAVE NO INFORMATION ON WHO SET IRONS BUT WE THINK LOCAL INDIVIDUALS MAY HAVE SEEN WOOD POSTS SET BY C.C.C. NOTES FROM 1938 - AND PLACED IRONS BY OR NEXT TO WOOD POSTS AS ~~THEY~~ THERE PROPERTY CORNERS OR FOREST SERVICE OWNER SHIP - OLD FENCE LINE IS STANDING MOST OF THE WAY TO CN '16

Certified corner restoration certificate prepared: Yes \_\_\_\_\_ No \_\_\_\_\_

Filed in county records at \_\_\_\_\_ Date \_\_\_\_\_ County Document No. \_\_\_\_\_

Identified on aerial photo No. \_\_\_\_\_ Which is filed at \_\_\_\_\_

Index No. 5-2  
(Alphabetical - Numerical)LAND CORNER RECORD  
(RECTANGULAR SURVEYS)T. 145 R. 28 5<sup>th</sup> Mer. N.F. Chippewa County Cass State Minnesota  
1/16 Corner common to sections Center & NW 1/4 - 30, and

## EXISTING SURVEYS

## Original Government Survey

Year surveyed \_\_\_\_\_  
Original monument \_\_\_\_\_  
(Wood post, stone, pile of stones, pipe, etc.)

## Bearing Trees

Species \_\_\_\_\_  
Diameter \_\_\_\_\_  
Bearing \_\_\_\_\_  
Distance \_\_\_\_\_

## Subsequent Corner Restoration

Year surveyed \_\_\_\_\_ By \_\_\_\_\_  
Where filed or recorded \_\_\_\_\_  
Monument \_\_\_\_\_  
(Original, concrete post, iron rod, etc.)

## Bearing Trees, Reference Objects

Species \_\_\_\_\_  
Diameter \_\_\_\_\_  
Bearing \_\_\_\_\_  
Distance \_\_\_\_\_

## Original Evidence Found

Year of search \_\_\_\_\_ By \_\_\_\_\_  
Monument found \_\_\_\_\_

## Original Bearing Trees Found

Species \_\_\_\_\_  
Diameter \_\_\_\_\_  
Bearing \_\_\_\_\_  
Distance \_\_\_\_\_

## Evidence of Subsequent Corner Restoration Found

Year of search 7-16-63 By J. M. Morrison  
New tag on S side 4 7" Red Oak - old  
tag on N. side 4 2 1/2" dead J. Pine  
Plantation post lies 12 ft. S.E. of new  
tag. Blue line painted E & S of corner.  
Squared stake rotted off lies beside  
plantation post.

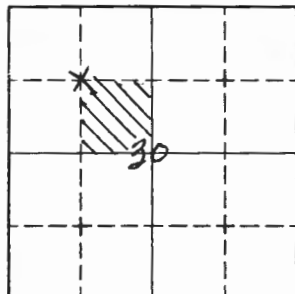

Sketch

○ Corner    ▨ F.S. Land

Relation of Evidence to Record Features Along Section Lines

Section line to sections \_\_\_\_\_  
 Object \_\_\_\_\_  
 Record distance \_\_\_\_\_  
 Measured distance \_\_\_\_\_

Other Evidence

Describe evidence of use and occupation such as roads, fences, clearings, timber cutting lines, plantations, etc.. Cite source of testimony if any. 3-21-95 RM-CK

FENCE PRS. S 81 W AT THIS COR.

FD. 1 1/4 IRON PIPE 3" HIGH FENCE IS 14' N OF IRON  
LARGE S. PINE W/ BLAZE ON E SIDE IS N75W - 19'  
BLAZE FACES IRON ✓ ON SIDE SLOPE

THICK BRUSH - R. OAK - SCATTERED PINE - N.P. PLANTATION SE  
PLANTATION POST LYING ON GRD 3' NE OF IRON  
AREA RECENTLY LOGGED NW - N - NE OF IRON

Perpetuation Record

Monument and accessories established. Include brief description of area. \_\_\_\_\_

\_\_\_\_\_  
 \_\_\_\_\_  
 \_\_\_\_\_  
 \_\_\_\_\_  
 \_\_\_\_\_

Certified corner restoration certificate prepared: Yes \_\_\_\_\_ No \_\_\_\_\_

Filed in county records at \_\_\_\_\_ Date \_\_\_\_\_ County Document No. \_\_\_\_\_

Identified on aerial photo No. \_\_\_\_\_ Which is filed at \_\_\_\_\_

At time of search:

1. Did you have the record description?

Yes \_\_\_\_\_ No

2. How was search area located?

Pacing, chaining, photos, maps, etc. \_\_\_\_\_

3. Man hours spent in search 1/2

4. Do you think additional search might recover evidence? Yes \_\_\_\_\_ No

5. Signature J. M. Morrison



Index No. S-3  
(Alphabetical - Numerical)

LAND CORNER RECORD  
(RECTANGULAR SURVEYS)

RD-7150-4 (Rev. 6/15/67)  
GPO 802-127

T. 145 R. 28 S. Mer. N.F. CHIPPEWA County CASS State MN.  
CENTER NORTH 1/16 Corner common to sections \_\_\_\_\_ and 30

EXISTING SURVEYS

Original Government Survey

Year surveyed \_\_\_\_\_  
Original monument \_\_\_\_\_  
(Wood post, stone, pile of stones, pipe, etc.)

Bearing Trees

Species \_\_\_\_\_  
Diameter \_\_\_\_\_  
Bearing \_\_\_\_\_  
Distance \_\_\_\_\_

Subsequent Corner Restoration

Year surveyed 8-1938 By WELLER  
Where filed or recorded C.C. FIELD BK #18 Pg. 30  
Monument \_\_\_\_\_  
(Original, concrete post, iron rod, etc.)

NO WITNESSES RECORDED ON  
PAGES

Bearing Trees, Reference Objects

Species \_\_\_\_\_  
Diameter \_\_\_\_\_  
Bearing \_\_\_\_\_  
Distance \_\_\_\_\_

Original Evidence Found

Year of search \_\_\_\_\_ By \_\_\_\_\_  
Monument found \_\_\_\_\_

Original Bearing Trees Found

Species \_\_\_\_\_  
Diameter \_\_\_\_\_  
Bearing \_\_\_\_\_  
Distance \_\_\_\_\_

Evidence of Subsequent Corner Restoration Found

Year of search 3-22-95 By R. MAIN + C. KRAUSE  
Ed. 1 1/4" x 10" HIGH IRON PIPE WITH COUPLER  
AT TOP - IN PLACE - 12" MAPLE IS NOW  
FENCE CORNER - WIRE RUNS WEST + N20W  
WIRE NW IS MOSTLY DOWN NEAR CORNER,  
IRON IS 3.5' N OF 12" MAPLE + 2' EAST OF WIRE

Bearing Trees, Reference Objects

OVER

Species \_\_\_\_\_  
Diameter \_\_\_\_\_  
Bearing \_\_\_\_\_  
Distance \_\_\_\_\_

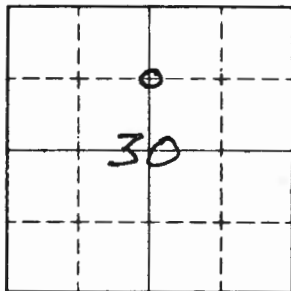

Sketch

○ Corner    ▨ F.S. Land

Relation of Evidence to Record Features Along Section Lines

Section line to sections \_\_\_\_\_  
 Object \_\_\_\_\_  
 Record distance \_\_\_\_\_  
 Measured distance \_\_\_\_\_

Other Evidence

Describe evidence of use and occupation such as roads, fences, clearings, timber cutting lines, plantations, etc.. Cite source of testimony if any. \_\_\_\_\_

PLACED FSLP ON 16" N. PINE N70W - 14.3' FROM IRON  
N. PINE HAS SCAR ON LOWER PORTION FACING IRON  
PIPE

At time of search:

1. Did you have the record description?

Yes \_\_\_\_\_ No \_\_\_\_\_

G.P.S. THIS POSITION TODAY - NO OLD TAG WAS  
FOUND AT THIS TIME

2. How was search area located?

Pacing, chaining, photos, maps,  
 etc. \_\_\_\_\_

Perpetuation Record

Monument and accessories established. Include brief description of area. \_\_\_\_\_

WIRE FENCE MOSTLY STANDING RUNS WEST OF  
THIS CORNER - FD. A FEW OLD BLAZES RUNNING  
EAST OF IRON ON SNAGS + OLD BLUE PAINT

3. Man hours spent in search \_\_\_\_\_

4. Do you think additional search might  
 recover evidence? Yes \_\_\_\_\_ No \_\_\_\_\_

Certified corner restoration certificate prepared: Yes \_\_\_\_\_ No \_\_\_\_\_

Filed in county records at \_\_\_\_\_ Date \_\_\_\_\_ County Document No. \_\_\_\_\_

5. Signature Curt Krause

Identified on aerial photo No. \_\_\_\_\_ Which is filed at \_\_\_\_\_

1. T. 115 R. 28 No. S-3 Cor. 1/16 Mer. 5 State Minnesota (Rectangular) N. F. Chippewa Dist. Bena

2. Corner Status

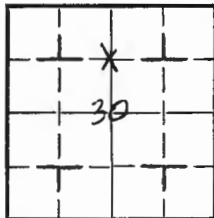

7. Photo Identification

Photo No. X

Ident. By: X

8. Plane Coordinate Position Data

State X Zone X

X X

Y X

Estab. By X

Field Book No. X

Where Filed X

9. Evaluation

Authentic X

Needs Verif. X Monument X

Re-estab. X Survey X

Land Status X

3. Original Description                      Vol.                      Page                      Where Recorded                     

4. Description of Corners:

Yellow Tag on S. E. side of 7" Birch  
Iron pipe believed to be installed by Indian Service

5. Investigation Notes: **AREA AROUND CORNER HAS VERY THICK BRUSH WITH SCATTERED PINE-OAK-BIRCH MOST OF FENCE POST IS STANDING (4) STRAND**

Traces of brushed out line west of tag on Portage Lake Road.

**BARBED WIRE  
CEDAR POSTS  
FAINT OLD BLUE  
PAINT VISIBLE**

*Re visited 7-10-63 - In or*

3-22-95 RM YCK

CN 1/16 SEC. 30

Fd. 1 1/4" IRON PIPE - IN PLACE - 10" ABOVE GROUND WITH COUPLER AT TOP

12" MAPLE IS FENCE CORNER POST (NOW) WIRE RUNS W + N20W

IRON IS 3.5' NORTH OF MAPLE AND 2' EAST OF WIRE N20W

PLACED FSLP ON 16" N. PINE N70W - 14.3' FROM IRON

N. PINE HAS SCAR FACING IRON PIPE

G.P.S. THIS POINT ON 3-21-95 - NO OLD TAG WAS FOUND

AREA TO N + NE WAS RECENTLY LOGGED

6. Signed [Signature] Title Forester Date 6/12/67

PERPETUATION RECORD

10. Monument:

11. Accessories

Field Book \_\_\_\_\_ Page \_\_\_\_\_

12. Set By \_\_\_\_\_ Title \_\_\_\_\_

License \_\_\_\_\_ Agency \_\_\_\_\_ Date \_\_\_\_\_

13. Recorded By \_\_\_\_\_ Volume \_\_\_\_\_ Page \_\_\_\_\_

(Agency)

(Date) \_\_\_\_\_ (City) \_\_\_\_\_ (County) \_\_\_\_\_ (State) \_\_\_\_\_

14. Remarks:

Index No. S-4  
(Alphabetical - Numerical)

LAND CORNER RECORD  
(RECTANGULAR SURVEYS)

R9-7150-4 (Rev. 6/13/67)  
GPO 802-127

T. 145 R. 28 S. Mer. N.F. CHIPPEWA County CASS State MN.  
NORTHEAST 1/16 Corner common to sections \_\_\_\_\_ and 30

EXISTING SURVEYS

Original Government Survey

Year surveyed \_\_\_\_\_  
Original monument \_\_\_\_\_  
(Wood post, stone, pile of stones, pipe, etc.)

Bearing Trees

Species \_\_\_\_\_  
Diameter \_\_\_\_\_  
Bearing \_\_\_\_\_  
Distance \_\_\_\_\_

Subsequent Corner Restoration

Year surveyed \_\_\_\_\_ By \_\_\_\_\_  
Where filed or recorded \_\_\_\_\_  
Monument \_\_\_\_\_  
(Original, concrete post, iron rod, etc.)

Bearing Trees, Reference Objects

Species \_\_\_\_\_  
Diameter \_\_\_\_\_  
Bearing \_\_\_\_\_  
Distance \_\_\_\_\_

Original Evidence Found

Year of search \_\_\_\_\_ By \_\_\_\_\_  
Monument found \_\_\_\_\_

Original Bearing Trees Found

Species \_\_\_\_\_  
Diameter \_\_\_\_\_  
Bearing \_\_\_\_\_  
Distance \_\_\_\_\_

Evidence of Subsequent Corner Restoration Found

Year of search 3-21-95 By R.M + C.K.  
FD. 2" X 36" WELL POINT WITH COUPLING  
AT TOP - 16" HIGH - ROCK MOUND AROUND  
IRON - IRON IS 18' SOUTH OF OLD FENCE.  
COR. POST WITH WIRE RUNNING N + W  
BURNED OUT RESIDENCE, APPROX. 150' NW OF COR.

Bearing Trees, Reference Objects

\_\_\_\_\_ OVER  
\_\_\_\_\_  
\_\_\_\_\_  
\_\_\_\_\_

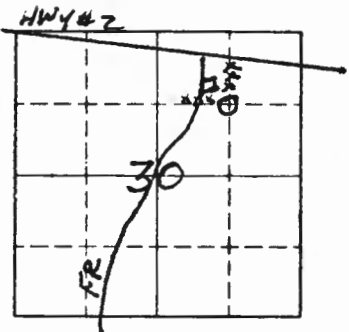

Sketch

○ Corner    ▨ F.S. Land

Relation of Evidence to Record Features Along Section Lines

Section line to sections \_\_\_\_\_

Object \_\_\_\_\_

Record distance \_\_\_\_\_

Measured distance \_\_\_\_\_

Other Evidence

Describe evidence of use and occupation such as roads, fences, clearings, timber cutting lines, plantations, etc.. Cite source of testimony if any. \_\_\_\_\_

**NO TAG WAS FOUND NEAR CORNER  
OLD BLUE LINE SOUTH & WEST OF IRON**

At time of search:

1. Did you have the record description?  
Yes \_\_\_\_\_ No \_\_\_\_\_

2. How was search area located?  
Pacing, chaining, photos, maps,  
etc. \_\_\_\_\_

3. Man hours spent in search \_\_\_\_\_

4. Do you think additional search might  
recover evidence? Yes \_\_\_\_\_ No \_\_\_\_\_

5. Signature Curt Krause

Perpetuation Record

Monument and accessories established. Include brief description of area. \_\_\_\_\_

Certified corner restoration certificate prepared: Yes \_\_\_\_\_ No \_\_\_\_\_

Filed in county records at \_\_\_\_\_ Date \_\_\_\_\_ County Document No. \_\_\_\_\_

Identified on aerial photo No. \_\_\_\_\_ Which is filed at \_\_\_\_\_

Index No. S-4  
(Alphabetical - Numerical)LAND CORNER RECORD  
(RECTANGULAR SURVEYS)

R9-560-11 (5/12/81)

T. 145 R. 28 5a Mer. N.F. Chippewa County Casa State Minnesota  
116 Corner common to sections NE 1/4 - 30 and \_\_\_\_\_

## EXISTING SURVEYS

## Original Government Survey

Year surveyed \_\_\_\_\_  
Original monument \_\_\_\_\_  
(Wood post, stone, pile of stones, pipe, etc.)

## Bearing Trees

Species \_\_\_\_\_  
Diameter \_\_\_\_\_  
Bearing \_\_\_\_\_  
Distance \_\_\_\_\_

## Subsequent Corner Restoration

Year surveyed \_\_\_\_\_ By \_\_\_\_\_  
Where filed or recorded \_\_\_\_\_  
Monument \_\_\_\_\_  
(Original, concrete post, iron rod, etc.)

## Bearing Trees, Reference Objects

Species \_\_\_\_\_  
Diameter \_\_\_\_\_  
Bearing \_\_\_\_\_  
Distance \_\_\_\_\_

## Original Evidence Found

Year of search \_\_\_\_\_ By \_\_\_\_\_  
Monument found \_\_\_\_\_

## Original Bearing Trees Found

Species \_\_\_\_\_  
Diameter \_\_\_\_\_  
Bearing \_\_\_\_\_  
Distance \_\_\_\_\_

## Evidence of Subsequent Corner Restoration Found

Year of search 7-16-63 By S. M. Morrison  
Tag on S. side of 9" Red oak, iron pipe  
11 8 ft. SW of tag - no brass cap on B.T.'s  
Another tag on E side of old Cottage Lake  
Road 2 c/s E. - Blue line pointed S  
& H.

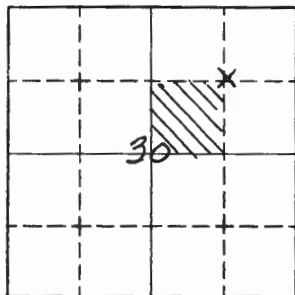

Sketch

○ Corner    ▨ F.S. Land

Relation of Evidence to Record Features Along Section Lines

Section line to sections \_\_\_\_\_  
 Object \_\_\_\_\_  
 Record distance \_\_\_\_\_  
 Measured distance \_\_\_\_\_

Other Evidence

Describe evidence of use and occupation such as roads, fences, clearings, timber cutting lines, plantations, etc.. Cite source of testimony if any. \_\_\_\_\_

3-21-95 RM & CK

Fd. 2" X 36" WELL POINT w/ COUPLER AT TOP - 16" ABOVE GRD.

ROCK RING AROUND IRON

18' SOUTH OF OLD FENCE COR. POSTS & WIRE N + W

BURNED OUT RESIDENCE NW OF COR.

NO TAGS Fd.

At time of search:

1. Did you have the record description?

Yes \_\_\_\_\_ No

2. How was search area located?

Pacing, ~~chaining~~, ~~photos~~, maps, etc. \_\_\_\_\_

3. Man hours spent in search 1/2

4. Do you think additional search might recover evidence? Yes \_\_\_\_\_ No

5. Signature S.M. Morison

Perpetuation Record

Monument and accessories established. Include brief description of area. \_\_\_\_\_

Certified corner restoration certificate prepared: Yes \_\_\_\_\_ No \_\_\_\_\_

Filed in county records at \_\_\_\_\_ Date \_\_\_\_\_ County Document No. \_\_\_\_\_

Identified on aerial photo No. \_\_\_\_\_ Which is filed at \_\_\_\_\_



Index No. S-7  
(Alphabetical - Numerical)

LAND CORNER RECORD  
(RECTANGULAR SURVEYS)

RS-5680-11 (5/12/81)

T. 145 R. 28 Mer. N.F. Chippewa County Cass State Wisconsin  
1/16 Corner common to sections 29 and

EXISTING SURVEYS

Original Government Survey	Original Evidence Found
Year surveyed _____ Original monument _____ <small>(Wood post, stone, pile of stones, pipe, etc.)</small>	Year of search _____ By _____ Monument found _____
<p style="text-align: center;">Bearing Trees</p> Species _____ Diameter _____ Bearing _____ Distance _____	<p style="text-align: center;">Original Bearing Trees Found</p> Species _____ Diameter _____ Bearing _____ Distance _____
<p style="text-align: center;">Subsequent Corner Restoration</p>	<p style="text-align: center;">Evidence of Subsequent Corner Restoration Found</p>
Year surveyed _____ By _____ Where filed or recorded _____ Monument _____ <small>(Original, concrete post, iron rod, etc.)</small>  <p style="text-align: center;">Bearing Trees, Reference Objects</p> Species _____ Diameter _____ Bearing _____ Distance _____	Year of search <u>12-9-65</u> By <u>J. Morrison &amp; D. Morgan</u> <u>State log on S. side of C. J. Paul on</u> <u>N. side of Hwy. # 2 - approx. corner</u> <u>has 1 chain S. of log - No brass cap</u> <u>or B.T.s. This is a measured</u> <u>distance from 1/4 corner 1/4 mi N.</u> <u>Blue like painted N. of corner</u>

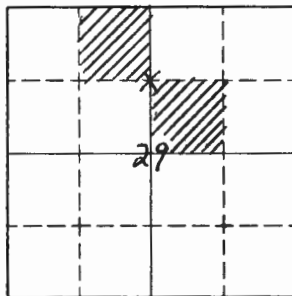

Sketch

○ Corner    ▨ F.S. Land

Relation of Evidence to Record Features Along Section Lines

Section line to sections \_\_\_\_\_  
 Object \_\_\_\_\_  
 Record distance \_\_\_\_\_  
 Measured distance \_\_\_\_\_

Other Evidence

Describe evidence of use and occupation such as roads, fences, clearings, timber cutting lines, plantations, etc.. Cite source of testimony if any. \_\_\_\_\_

At time of search:

1. Did you have the record description?

Yes \_\_\_\_\_ No

2. How was search area located?

Pacing, chaining, photos, maps,

etc. *seen from Highway*

3. Man hours spent in search *1*

4. Do you think additional search might recover evidence? Yes \_\_\_\_\_ No

5. Signature *S. Korman*

Perpetuation Record

Monument and accessories established. Include brief description of area. \_\_\_\_\_

Certified corner restoration certificate prepared: Yes \_\_\_\_\_ No \_\_\_\_\_

Filed in county records at \_\_\_\_\_ Date \_\_\_\_\_ County Document No. \_\_\_\_\_

Identified on aerial photo No. \_\_\_\_\_ Which is filed at \_\_\_\_\_

Index No. S-12  
(Alphabetical - Numerical)

LAND CORNER RECORD  
(RECTANGULAR SURVEYS)

T. 145 R. 28 Mer. N.F. Chippewa County Cass State Minnesota  
1/16 Corner common to sections 28 and

EXISTING SURVEYS

**Original Government Survey**

Year surveyed \_\_\_\_\_

Original monument \_\_\_\_\_  
(Wood post, stone, pile of stones, pipe, etc.)

**Bearing Trees**

Species \_\_\_\_\_

Diameter \_\_\_\_\_

Bearing \_\_\_\_\_

Distance \_\_\_\_\_

**Original Evidence Found**

Year of search \_\_\_\_\_ By \_\_\_\_\_

Monument found \_\_\_\_\_

**Original Bearing Trees Found**

Species \_\_\_\_\_

Diameter \_\_\_\_\_

Bearing \_\_\_\_\_

Distance \_\_\_\_\_

**Subsequent Corner Restoration**

Year surveyed \_\_\_\_\_ By \_\_\_\_\_

Where filed or recorded \_\_\_\_\_

Monument \_\_\_\_\_  
(Original, concrete post, iron rod, etc.)

**Bearing Trees, Reference Objects**

Species \_\_\_\_\_

Diameter \_\_\_\_\_

Bearing \_\_\_\_\_

Distance \_\_\_\_\_

**Evidence of Subsequent Corner Restoration Found**

Year of search 12-3-65 By S. Morrin & D. Morgan  
log on E. side of 10" Birch which  
is approx corner. Blue line painted  
E. from corner. This approx. corner  
established by compass & chaining from  
approx corner 12 chas E. & by correlation  
w/ old blazed lines running E. & N. from  
this point.

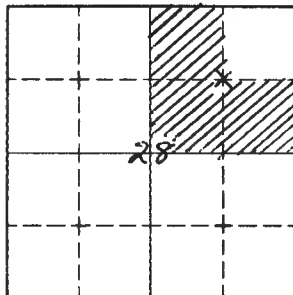

Sketch

○ Corner    ▨ F.S. Land

Relation of Evidence to Record Features Along Section Lines

Section line to sections \_\_\_\_\_  
 Object \_\_\_\_\_  
 Record distance \_\_\_\_\_  
 Measured distance \_\_\_\_\_

Other Evidence

Describe evidence of use and occupation such as roads, fences, clearings, timber cutting lines, plantations, etc.. Cite source of testimony if any. \_\_\_\_\_  
 \_\_\_\_\_  
 \_\_\_\_\_  
 \_\_\_\_\_  
 \_\_\_\_\_

At time of search:

1. Did you have the record description?

Yes \_\_\_\_\_ No

2. How was search area located?

Pacing, chaining, photos, maps, etc. \_\_\_\_\_  
 \_\_\_\_\_  
 \_\_\_\_\_

3. Man hours spent in search 1

4. Do you think additional search might recover evidence? Yes \_\_\_\_\_ No

Perpetuation Record

Monument and accessories established. Include brief description of area. \_\_\_\_\_  
 \_\_\_\_\_  
 \_\_\_\_\_  
 \_\_\_\_\_  
 \_\_\_\_\_

Certified corner restoration certificate prepared: Yes \_\_\_\_\_ No \_\_\_\_\_

Filed in county records at \_\_\_\_\_ Date \_\_\_\_\_ County Document No. \_\_\_\_\_

Identified on aerial photo No. \_\_\_\_\_ Which is filed at \_\_\_\_\_

5. Signature S. Morrison

Index No. S-13  
(Alphabetical - Numerical)

LAND CORNER RECORD  
(RECTANGULAR SURVEYS)

RS-5680-11 (5/12/61)

T. 145 R. 28 Mer. N.F. 5<sup>th</sup> Chippen County Casa State Missouri  
1/16 Corner common to sections 27 and 38

EXISTING SURVEYS

Original Government Survey	Original Evidence Found
Year surveyed _____ Original monument _____ <small>(Wood post, stone, pile of stones, pipe, etc.)</small>	Year of search _____ By _____ Monument found _____
<p style="text-align: center;">Bearing Trees</p> Species _____ Diameter _____ Bearing _____ Distance _____	<p style="text-align: center;">Original Bearing Trees Found</p> Species _____ Diameter _____ Bearing _____ Distance _____
<p style="text-align: center;">Subsequent Corner Restoration</p>	<p style="text-align: center;">Evidence of Subsequent Corner Restoration Found</p>
Year surveyed _____ By _____ Where filed or recorded _____ Monument _____ <small>(Original, concrete post, iron rod, etc.)</small>	Year of search <u>12-3-65</u> By <u>S. Morrison &amp; D. Margo</u> <u>Old tag on S. side of 6" Birch - blue</u> <u>line painted E. &amp; W. of corner. This</u> <u>tag was in place and is approx.</u> <u>28 ds. from approx 1/16 corner to</u> <u>E. &amp; W.</u>
<p style="text-align: center;">Bearing Trees, Reference Objects</p> Species _____ Diameter _____ Bearing _____ Distance _____	_____ _____ _____ _____

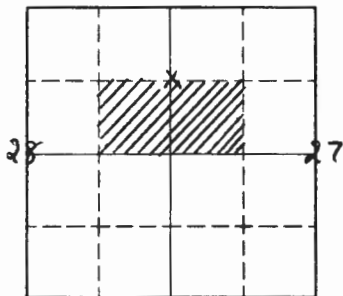

Sketch

○ Corner    ▨ F.S. Land

Relation of Evidence to Record Features Along Section Lines

Section line to sections \_\_\_\_\_  
 Object \_\_\_\_\_  
 Record distance \_\_\_\_\_  
 Measured distance \_\_\_\_\_

Other Evidence

Describe evidence of use and occupation such as roads, fences, clearings, timber cutting lines, plantations, etc.. Cite source of testimony if any. \_\_\_\_\_  
 \_\_\_\_\_  
 \_\_\_\_\_  
 \_\_\_\_\_  
 \_\_\_\_\_

At time of search:

1. Did you have the record description?

Yes \_\_\_\_\_ No

2. How was search area located?

Pacing, chaining, photos, maps, etc. \_\_\_\_\_  
 \_\_\_\_\_

3. Man hours spent in search 1

4. Do you think additional search might

recover evidence? Yes \_\_\_\_\_ No

5. Signature S. Morrison

Perpetuation Record

Monument and accessories established. Include brief description of area. \_\_\_\_\_  
 \_\_\_\_\_  
 \_\_\_\_\_  
 \_\_\_\_\_

Certified corner restoration certificate prepared: Yes \_\_\_\_\_ No \_\_\_\_\_

Filed in county records at \_\_\_\_\_ Date \_\_\_\_\_ County Document No. \_\_\_\_\_

Identified on aerial photo No. \_\_\_\_\_ Which is filed at \_\_\_\_\_

Index No. S-14  
(Alphabetical - Memorial)LAND CORNER RECORD  
(RECTANGULAR SURVEYS)

NS-5660-11 (5/12/61)

T. 145 R. 28 Mer. N.F. Chippewa County Cass State Minnesota  
1/16 Corner common to sections 27 and

## EXISTING SURVEYS

Original Government Survey	Original Evidence Found
Year surveyed _____	Year of search _____ By _____
Original monument _____ <small>(Wood post, stone, pile of stones, pipe, etc.)</small>	Monument found _____
Bearing Trees	Original Bearing Trees Found
Species _____	Species _____
Diameter _____	Diameter _____
Bearing _____	Bearing _____
Distance _____	Distance _____
Subsequent Corner Restoration	Evidence of Subsequent Corner Restoration Found
Year surveyed _____ By _____	Year of search <u>12-3-65</u> By <u>L. Morrison &amp; D. Morgan</u>
Where filed or recorded _____	<u>Location N.E. side of 6" Birch - Corner</u>
Monument _____ <small>(Original, concrete post, iron rod, etc.)</small>	<u>Consists of iron rod &amp; white post</u>
	<u>has 9 ft NE of top. Corner is approx</u>
	<u>40 ft N. of NE corner of cemetery -</u>
	<u>Blue like painted w. from corner.</u>
	<u>This post &amp; iron rod have previously</u>
	<u>Tag put up at this time.</u>
Bearing Trees, Reference Objects	
Species _____	
Diameter _____	
Bearing _____	
Distance _____	

Relation of Evidence to Record Features Along Section Lines

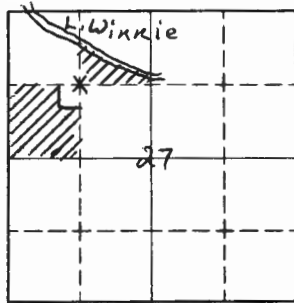

Sketch

○ Corner    ▨ F.S. Land

Section line to sections \_\_\_\_\_  
 Object \_\_\_\_\_  
 Record distance \_\_\_\_\_  
 Measured distance \_\_\_\_\_

Other Evidence

Describe evidence of use and occupation such as roads, fences, clearings, timber cutting lines, plantations, etc.. Cite source of testimony if any. \_\_\_\_\_

At time of search:

1. Did you have the record description?  
Yes \_\_\_\_\_ No

2. How was search area located?  
Pacing, chaining, photos, maps,  
etc. *@ N.E. corner of Roma  
Cemetery*

3. Man hours spent in search *1*

4. Do you think additional search might  
recover evidence? Yes \_\_\_\_\_ No

5. Signature *S. Morrison*

Perpetuation Record

Monument and accessories established. Include brief description of area. \_\_\_\_\_

Certified corner restoration certificate prepared: Yes \_\_\_\_\_ No \_\_\_\_\_

Filed in county records of \_\_\_\_\_ Date \_\_\_\_\_ County Document No. \_\_\_\_\_

Identified on aerial photo No. \_\_\_\_\_ Which is filed at \_\_\_\_\_



Index No. T-2  
(Alphabetical - Numerical)LAND CORNER RECORD  
(RECTANGULAR SURVEYS)

RS-5660-11 (5/12/61)

T. 145 R. 28 5<sup>th</sup> Mer. N.F. Chippewa County Cass State Minnesota  
W 1/4 Corner common to sections E-W Center line, 30 and \_\_\_\_\_

## EXISTING SURVEYS

## Original Government Survey

Year surveyed \_\_\_\_\_  
Original monument \_\_\_\_\_  
(Wood post, stone, pile of stones, pipe, etc.)

## Bearing Trees

Species \_\_\_\_\_  
Diameter \_\_\_\_\_  
Bearing \_\_\_\_\_  
Distance \_\_\_\_\_

## Subsequent Corner Restoration

Year surveyed \_\_\_\_\_ By \_\_\_\_\_  
Where filed or recorded \_\_\_\_\_  
Monument \_\_\_\_\_  
(Original, concrete post, iron rod, etc.)

## Bearing Trees, Reference Objects

Species \_\_\_\_\_  
Diameter \_\_\_\_\_  
Bearing \_\_\_\_\_  
Distance \_\_\_\_\_

## Original Evidence Found

Year of search \_\_\_\_\_ By \_\_\_\_\_  
Monument found \_\_\_\_\_

## Original Bearing Trees Found

Species \_\_\_\_\_  
Diameter \_\_\_\_\_  
Bearing \_\_\_\_\_  
Distance \_\_\_\_\_

## Evidence of Subsequent Corner Restoration Found

Year of search 7-2-63 By Morrison & Tucker  
Tag on E. side of 4" White Oak. Blue  
line painted N & E of Corner. No  
grass cap on B.T.'s. This approx.  
Corner established by Morrison &  
Tucker.

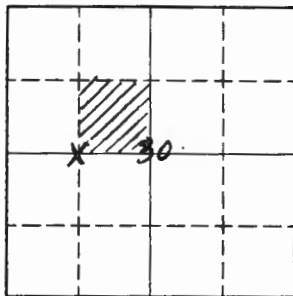

Sketch

○ Corner    ▨ F.S. Land

At time of search:

1. Did you have the record description?

Yes \_\_\_ No

2. How was search area located?

Recing, chaining, photos, maps, etc.

3. Man hours spent in search 2

4. Do you think additional search might recover evidence? Yes \_\_\_ No

5. Signature J. M. Morrison

Relation of Evidence to Record Features Along Section Lines

Section line to sections \_\_\_\_\_  
 Object \_\_\_\_\_  
 Record distance \_\_\_\_\_  
 Measured distance \_\_\_\_\_

Other Evidence

Describe evidence of use and occupation such as roads, fences, clearings, timber cutting lines, plantations, etc.. Cite source of testimony if any. \_\_\_\_\_

Perpetuation Record

Monument and accessories established. Include brief description of area. \_\_\_\_\_

Certified corner restoration certificate prepared: Yes \_\_\_ No \_\_\_

Filed in county records of \_\_\_\_\_ Date \_\_\_\_\_ County Document No. \_\_\_\_\_

Identified on aerial photo No. \_\_\_\_\_ Which is filed at \_\_\_\_\_

## LAND CORNER RECORD

5880-2

1. T 145 R 28 No. T-4 Cor. 1/16 Mer. 5 State Minnesota (Rectangular) N. F. Chippewa Dist. Bena

## 2. Corner Status

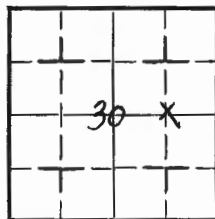

## 7. Photo Identification

Photo No. ~~\_\_\_\_\_~~Ident. By: ~~\_\_\_\_\_~~

## 8. Plane Coordinate Position Data

State ~~\_\_\_\_\_~~ Zone ~~\_\_\_\_\_~~X ~~\_\_\_\_\_~~Y ~~\_\_\_\_\_~~Estab. By ~~\_\_\_\_\_~~Field Book No. ~~\_\_\_\_\_~~Where Filed ~~\_\_\_\_\_~~

## 9. Evaluation

Authentic ~~\_\_\_\_\_~~Needs Verif. ~~\_\_\_\_\_~~ Monument ~~\_\_\_\_\_~~Re-estab. ~~\_\_\_\_\_~~ Survey XLand Status ~~\_\_\_\_\_~~

3. Original Description \_\_\_\_\_ Vol. \_\_\_\_\_ Page \_\_\_\_\_ Where Recorded \_\_\_\_\_

## 4. Description of Corners:

Alum. tag on W. side of 12" Black Spruce

## 5. Investigation Notes:

Brushed out line visible south from tag on Portage Lake Road to corner.

6. Signed [Signature] Title Forester Date 6/61

PERPETUATION RECORD

10. Monument:

11. Accessories

12. Set By _____ Title _____ License _____ Agency _____ Date _____	Field Book _____ Page _____ 13. Recorded By _____ Volume _____ Page _____ (Agency) _____ (Date) (City) (County) (State)
---	---

14. Remarks:

Index No. I 5  
(Alphabetical - Numerical)

BOOK # 1  
PAGE # 17  
5<sup>th</sup>

LAND CORNER RECORD  
(RECTANGULAR SURVEYS)

RS-5680-11 15/12/81

T. 145 R. 28 Mer. N.F. Chippewa County Cass State Miss  
1/4 Corner common to sections 29 & 30 and

EXISTING SURVEYS

**Original Government Survey**

Year surveyed \_\_\_\_\_

Original monument \_\_\_\_\_  
(Wood post, stone, pile of stones, pipe, etc.)

**Bearing Trees**

Species \_\_\_\_\_

Diameter \_\_\_\_\_

Bearing \_\_\_\_\_

Distance \_\_\_\_\_

**Original Evidence Found**

Year of search \_\_\_\_\_ By \_\_\_\_\_

Monument found \_\_\_\_\_

**Original Bearing Trees Found**

Species \_\_\_\_\_

Diameter \_\_\_\_\_

Bearing \_\_\_\_\_

Distance \_\_\_\_\_

**Subsequent Corner Restoration**

Year surveyed \_\_\_\_\_ By \_\_\_\_\_

Where filed or recorded \_\_\_\_\_

Monument \_\_\_\_\_  
(Original, concrete post, iron rod, etc.)

**Bearing Trees, Reference Objects**

Species \_\_\_\_\_

Diameter \_\_\_\_\_

Bearing \_\_\_\_\_

Distance \_\_\_\_\_

**Evidence of Subsequent Corner Restoration Found**

Year of search 6-21-68 By Morrison & Morgan  
Tag on W side of 4" maple - approx  
corner lies 6 ft E of tag. Blue wax  
pointed E & S. This approx corner established  
by compass (bearing from approx corner  
1/4 mile.

Relation of Evidence to Record Features Along Section Lines

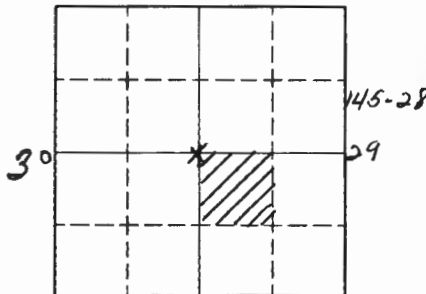

Sketch

○ Corner    ▨ F.S. Land

Section line to sections \_\_\_\_\_  
 Object \_\_\_\_\_  
 Record distance \_\_\_\_\_  
 Measured distance \_\_\_\_\_

Other Evidence

Describe evidence of use and occupation such as roads, fences, clearings, timber cutting lines, plantations, etc.. Cite source of testimony if any. \_\_\_\_\_  
 \_\_\_\_\_  
 \_\_\_\_\_  
 \_\_\_\_\_

At time of search:

1. Did you have the record description?

Yes \_\_\_\_\_ No X

2. How was search area located?

Beeing, chaining, photos, maps, etc. \_\_\_\_\_  
 \_\_\_\_\_

3. Man hours spent in search 1

4. Do you think additional search might recover evidence? Yes \_\_\_\_\_ No X

5. Signature S. M. Morrison

Perpetuation Record

Monument and accessories established. Include brief description of area. \_\_\_\_\_  
 \_\_\_\_\_  
 \_\_\_\_\_  
 \_\_\_\_\_

Certified corner restoration certificate prepared: Yes \_\_\_\_\_ No \_\_\_\_\_

Filed in county records at \_\_\_\_\_ Date \_\_\_\_\_ County Document No. \_\_\_\_\_

Identified on aerial photo No. \_\_\_\_\_ Which is filed at \_\_\_\_\_

Index No. 7-6  
(Alphabetical - Numbered)LAND CORNER RECORD  
(RECTANGULAR SURVEYS)

RS-6680-11 (5/12/64)

T. 14S R. 28 Mer. N.F. Chippewa County Cass State Miss  
W 1/4 on E.W. Centralia Corner common to sections 29 and

## EXISTING SURVEYS

## Original Government Survey

Year surveyed \_\_\_\_\_

Original monument \_\_\_\_\_  
(Wood post, stone, pile of stones, pipe, etc.)

## Bearing Trees

Species \_\_\_\_\_

Diameter \_\_\_\_\_

Bearing \_\_\_\_\_

Distance \_\_\_\_\_

## Original Evidence Found

Year of search \_\_\_\_\_ By \_\_\_\_\_

Monument found \_\_\_\_\_

## Original Bearing Trees Found

Species \_\_\_\_\_

Diameter \_\_\_\_\_

Bearing \_\_\_\_\_

Distance \_\_\_\_\_

## Subsequent Corner Restoration

Year surveyed \_\_\_\_\_ By \_\_\_\_\_

Where filed or recorded \_\_\_\_\_

Monument \_\_\_\_\_  
(Original, concrete post, iron rod, etc.)

## Bearing Trees, Reference Objects

Species \_\_\_\_\_

Diameter \_\_\_\_\_

Bearing \_\_\_\_\_

Distance \_\_\_\_\_

## Evidence of Subsequent Corner Restoration Found

Year of search 6-20-68 By Narrison & MorganTag on W side of 9" Red Oak and is  
approx corner. Blue same painted  
S & W. This approx corner established  
by compass & chaining from approx  
corner 1/2 mi S and by correlation with  
corner to the North.

Relation of Evidence to Record Features Along Section Lines

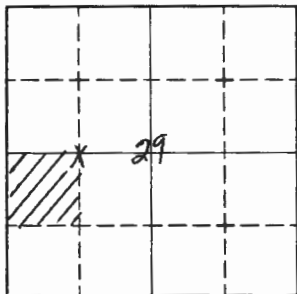

Sketch

○ Corner    ▨ F.S. Land

Section line to sections \_\_\_\_\_

Object \_\_\_\_\_

Record distance \_\_\_\_\_

Measured distance \_\_\_\_\_

Other Evidence

Describe evidence of use and occupation such as roads, fences, clearings, timber cutting lines, plantations, etc.. Cite source of testimony if any. \_\_\_\_\_

\_\_\_\_\_  
 \_\_\_\_\_  
 \_\_\_\_\_  
 \_\_\_\_\_  
 \_\_\_\_\_

At time of search:

1. Did you have the record description?

Yes \_\_\_\_\_ No X \_\_\_\_\_

2. How was search area located?

~~Boating~~, chaining, photos, maps,  
 etc. \_\_\_\_\_

3. Man hours spent in search 1

4. Do you think additional search might  
 recover evidence? Yes \_\_\_\_\_ No X \_\_\_\_\_

5. Signature S. M. Morrison

Perpetuation Record

Monument and accessories established. Include brief description of area. \_\_\_\_\_

\_\_\_\_\_  
 \_\_\_\_\_  
 \_\_\_\_\_  
 \_\_\_\_\_  
 \_\_\_\_\_

Certified corner restoration certificate prepared: Yes \_\_\_\_\_ No \_\_\_\_\_

Filed in county records at \_\_\_\_\_ Date \_\_\_\_\_ County Document No. \_\_\_\_\_

Identified on aerial photo No. \_\_\_\_\_ Which is filed at \_\_\_\_\_



Index No. T 8  
(Alphabetical - Numerical)

LAND CORNER RECORD  
(RECTANGULAR SURVEYS)

RD-5680-11 (5/12/61)

T. 145 R. 28 Mer. N.F. Chippewa County Casa State Miss  
E 1/4 corner on E-N section corner common to sections 27 and \_\_\_\_\_

EXISTING SURVEYS

Original Government Survey

Year surveyed \_\_\_\_\_  
 Original monument \_\_\_\_\_  
(Wood post, stone, pile of stones, pipe, etc.)

Bearing Trees

Species \_\_\_\_\_  
 Diameter \_\_\_\_\_  
 Bearing \_\_\_\_\_  
 Distance \_\_\_\_\_

Subsequent Corner Restoration

Year surveyed \_\_\_\_\_ By \_\_\_\_\_  
 Where filed or recorded \_\_\_\_\_  
 Monument \_\_\_\_\_  
(Original, concrete post, iron rod, etc.)

Bearing Trees, Reference Objects

Species \_\_\_\_\_  
 Diameter \_\_\_\_\_  
 Bearing \_\_\_\_\_  
 Distance \_\_\_\_\_

Original Evidence Found

Year of search \_\_\_\_\_ By \_\_\_\_\_  
 Monument found \_\_\_\_\_

Original Bearing Trees Found

Species \_\_\_\_\_  
 Diameter \_\_\_\_\_  
 Bearing \_\_\_\_\_  
 Distance \_\_\_\_\_

Evidence of Subsequent Corner Restoration Found

Year of search 6-21-68 By Margaret Morgan  
log on N. side of 8" Birch and is  
approx corner. This approx corner  
established by using the intersection  
of 2 old painted lines and by correlation  
with the type map. Blue line painted  
E. 15 chs to swamp edge & N to  
swamp edge.

## Relation of Evidence to Record Features Along Section Lines

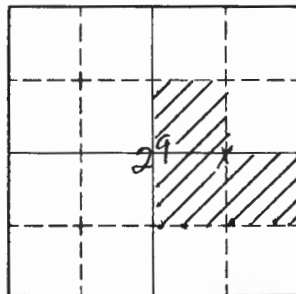

Sketch

○ Corner    ▨ F.S. Land

Section line to sections \_\_\_\_\_  
 Object \_\_\_\_\_  
 Record distance \_\_\_\_\_  
 Measured distance \_\_\_\_\_

## Other Evidence

Describe evidence of use and occupation such as roads, fences, clearings, timber cutting lines, plantations, etc.. Cite source of testimony if any. \_\_\_\_\_  
 \_\_\_\_\_  
 \_\_\_\_\_  
 \_\_\_\_\_  
 \_\_\_\_\_

At time of search:

1. Did you have the record description?

Yes \_\_\_\_\_ No X \_\_\_\_\_

2. How was search area located?

~~Ranging~~, chaining, photos, maps,  
etc. \_\_\_\_\_  
 \_\_\_\_\_3. Man hours spent in search 1 \_\_\_\_\_

4. Do you think additional search might

recover evidence? Yes \_\_\_\_\_ No X \_\_\_\_\_5. Signature J. M. Morrison \_\_\_\_\_

## Perpetuation Record

Monument and accessories established. Include brief description of area. \_\_\_\_\_  
 \_\_\_\_\_  
 \_\_\_\_\_  
 \_\_\_\_\_  
 \_\_\_\_\_

Certified corner restoration certificate prepared: Yes \_\_\_\_\_ No \_\_\_\_\_

Filed in county records at \_\_\_\_\_ Date \_\_\_\_\_ County Document No. \_\_\_\_\_

Identified on aerial photo No. \_\_\_\_\_ Which is filed at \_\_\_\_\_



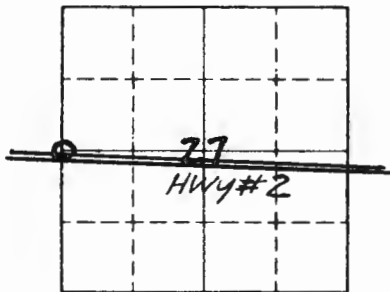

Sketch

○ Corner    ▨ F.S. Land

Relation of Evidence to Record Features Along Section Lines

Section line to sections N. 56T. 27-38  
 Object LV. SWP.  
 Record distance 3 CHS. = 520'  
 Measured distance \_\_\_\_\_

Other Evidence

Describe evidence of use and occupation such as roads, fences, clearings, timber cutting lines, plantations, etc.. Cite source of testimony if any.

CORNER IS IN MARSH ON NORTH SIDE OF HWY #2

247.5'

GJELHANG HASTIE OF 3.75 CHS. NORTH OF R.R. TRACK

6/29/92 C. KRAUSE - G. BRAMA

ALSO MAGNETIC PELLET UNDER POST IN MARSH

Perpetuation Record

Monument and accessories established. Include brief description of area.

SET 8' STEEL SKIN POST 3.0' NORTH OF POST  
POST IS 69' NORTH OF CENTERLINE OF HWY #2

At time of search:

1. Did you have the record description?

Yes  No \_\_\_\_\_

2. How was search area located?

Pacing, chaining, photos, maps, etc.

3. Man hours spent in search 2 HRS.

4. Do you think additional search might recover evidence? Yes \_\_\_\_\_ No \_\_\_\_\_

5. Signature Curt Krause

Certified corner restoration certificate prepared: Yes \_\_\_\_\_ No \_\_\_\_\_

Filed in county records at \_\_\_\_\_ Date \_\_\_\_\_ County Document No. \_\_\_\_\_

Identified on aerial photo No. \_\_\_\_\_ Which is filed at \_\_\_\_\_

T. 145 R. 28 <sup>114</sup> Mer. N.F. Chippewa County Cass State Minnesota  
Corner common to sections Center of Section 27 and \_\_\_\_\_

## EXISTING SURVEYS

## Original Government Survey

Year surveyed \_\_\_\_\_

Original monument \_\_\_\_\_  
(Wood post, stone, pile of stones, pipe, etc.)

## Bearing Trees

Species 1. NA \_\_\_\_\_Diameter 1.5 \_\_\_\_\_

Bearing \_\_\_\_\_

Distance \_\_\_\_\_

## Original Evidence Found

Year of search \_\_\_\_\_ By \_\_\_\_\_

Monument found \_\_\_\_\_

## Original Bearing Trees Found

Species \_\_\_\_\_

Diameter \_\_\_\_\_

Bearing \_\_\_\_\_

Distance \_\_\_\_\_

## Subsequent Corner Restoration

Year surveyed \_\_\_\_\_ By \_\_\_\_\_

Where filed or recorded \_\_\_\_\_

Monument \_\_\_\_\_  
(Original, concrete post, iron rod, etc.)

## Bearing Trees, Reference Objects

Species \_\_\_\_\_

Diameter \_\_\_\_\_

Bearing \_\_\_\_\_

Distance \_\_\_\_\_

## Evidence of Subsequent Corner Restoration Found

Year of search 7-10-63 By Thomson

Corner consists of a metal pipe set in concrete with a square cedar post painted red beside it. A metal tag is on a 10" Jack Pine which has been cut down - & lies approx 10 ft. W. of corner. Corner is on South edge of R.E.A. Clearing.

Relation of Evidence to Record Features Along Section Lines

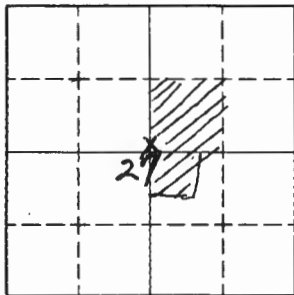

Sketch

○ Corner    ▨ F.S. Land

Section line to sections \_\_\_\_\_  
 Object \_\_\_\_\_  
 Record distance \_\_\_\_\_  
 Measured distance \_\_\_\_\_

Other Evidence

Describe evidence of use and occupation such as roads, fences, clearings, timber cutting lines, plantations, etc.. Cite source of testimony if any. \_\_\_\_\_  
 \_\_\_\_\_  
 \_\_\_\_\_  
 \_\_\_\_\_

At time of search:

1. Did you have the record description?

Yes \_\_\_\_\_ No

2. How was search area located?

Pacing, chaining, photos, maps, etc. *followed R.E.A. Line*

3. Man hours spent in search \_\_\_\_\_

4. Do you think additional search might recover evidence? Yes \_\_\_\_\_ No

5. Signature *S.M. Morrison*

Perpetuation Record

Monument and accessories established. Include brief description of area. \_\_\_\_\_  
 \_\_\_\_\_  
 \_\_\_\_\_  
 \_\_\_\_\_

Certified corner restoration certificate prepared: Yes \_\_\_\_\_ No \_\_\_\_\_

Filed in county records at \_\_\_\_\_ Date \_\_\_\_\_ County Document No. \_\_\_\_\_

Identified on aerial photo No. \_\_\_\_\_ Which is filed at \_\_\_\_\_

T. 145 R. 28 Mer. N.F. Chickasha County Cass State Oklahoma  
ownership Corner common to sections 30 and

EXISTING SURVEYS

Original Government Survey

Year surveyed \_\_\_\_\_  
 Original monument \_\_\_\_\_  
(Wood post, stone, pile of stones, pipe, etc.)

Bearing Trees

Species \_\_\_\_\_  
 Diameter \_\_\_\_\_  
 Bearing \_\_\_\_\_  
 Distance \_\_\_\_\_

Original Evidence Found

Year of search \_\_\_\_\_ By \_\_\_\_\_  
 Monument found \_\_\_\_\_

Original Bearing Trees Found

Species \_\_\_\_\_  
 Diameter \_\_\_\_\_  
 Bearing \_\_\_\_\_  
 Distance \_\_\_\_\_

Subsequent Corner Restoration

Year surveyed \_\_\_\_\_ By \_\_\_\_\_  
 Where filed or recorded \_\_\_\_\_  
 Monument \_\_\_\_\_  
(Original, concrete post, iron rod, etc.)

Bearing Trees, Reference Objects

Species \_\_\_\_\_  
 Diameter \_\_\_\_\_  
 Bearing \_\_\_\_\_  
 Distance \_\_\_\_\_

Evidence of Subsequent Corner Restoration Found

Year of search 7-2-63 By Morrison & Tucker  
Approx. ownership corner which  
lies 15 chs. W. of S. 1/4 corner on  
N-S center line of Sec. 30, T. 145-28  
Tag on NE side of 3" Ash. Blue  
line painted N. & E. of corner.  
No brass cap or B.T.s. This approx  
corner established by Morrison  
& Tucker

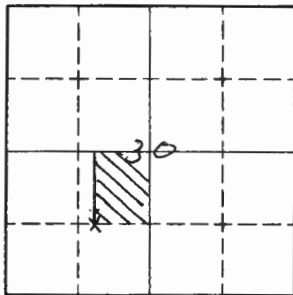

Sketch

○ Corner    ▨ F.S. Land

Relation of Evidence to Record Features Along Section Lines

Section line to sections \_\_\_\_\_  
 Object \_\_\_\_\_  
 Record distance \_\_\_\_\_  
 Measured distance \_\_\_\_\_

Other Evidence

Describe evidence of use and occupation such as roads, fences, clearings, timber cutting lines, plantations, etc.. Cite source of testimony if any.

*The land adjoining this to the west is now owned by Maurice Johnson of Bone - His deed shows that he owns lot 43 except E. 15 acres, which is Forest Service.*

At time of search:

1. Did you have the record description?

Yes \_\_\_\_\_ No X

2. How was search area located?

Pacing, chaining, photos, maps, etc.

3. Man hours spent in search 2

4. Do you think additional search might recover evidence? Yes \_\_\_\_\_ No ✓

5. Signature J. M. Morrison

Perpetuation Record

Monument and accessories established. Include brief description of area. \_\_\_\_\_

Certified corner restoration certificate prepared: Yes \_\_\_\_\_ No \_\_\_\_\_

Filed in county records at \_\_\_\_\_ Date \_\_\_\_\_ County Document No. \_\_\_\_\_

Identified on aerial photo No. \_\_\_\_\_ Which is filed at \_\_\_\_\_



1. T115 R 28 No. U-3 Cor. 1/16 Mer. 5 State <sup>(Rectangular)</sup> Minnesota N. F. Chippewa Dist. Bena

2. Corner Status

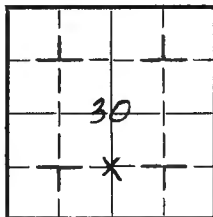

7. Photo Identification

Photo No. ~~\_\_\_\_\_~~  
Ident. By: ~~\_\_\_\_\_~~

8. Plane Coordinate Position Data

State \_\_\_\_\_ Zone \_\_\_\_\_  
X \_\_\_\_\_  
Y \_\_\_\_\_  
Estab. By \_\_\_\_\_  
Field Book No. \_\_\_\_\_  
Where Filed \_\_\_\_\_

9. Evaluation

Authentic \_\_\_\_\_  
Needs Verif. \_\_\_\_\_ Monument \_\_\_\_\_  
Re-estab. Survey  \_\_\_\_\_  
Land Status \_\_\_\_\_

3. Original Description \_\_\_\_\_ Vol. \_\_\_\_\_ Page \_\_\_\_\_ Where Recorded \_\_\_\_\_

4. Description of Corners:

Yellow Tag on NW side of 8" Red Oak

5. Investigation Notes:

Tag on N-S of brushed out  $\frac{1}{4}$  line. South of R.E.A. line.

3-27-95 AM+CK

FROM FSLP ON W SIDE OF 9" W. OAK ON E SIDE OF FR 2131  
RAN LINE EAST TO SWP - N. PINE PLANTATION WELL NORTH OF LINE  
ALONG NORTH SIDE OF LINE

6. Signed [Signature] Title Forester Date 6/61

PERPETUATION RECORD

10. Monument:

11. Accessories

<p>12. Set By _____ Title _____                  Licensee _____ Agency _____ Date _____</p>	<p>13. Recorded By _____ Volume _____ Page _____                  (Agency)                  _____                  (Date) (City) (County) (State)</p>
---	---

14. Remarks:

LAND CORNER RECORD

1. T. 115 R. 28 No. 11-1 Cor. 1/16 Mer. 5 State <sup>(Rectangular)</sup> Minnesota N. F. Chippewa Dist. Bena

2. Corner Status

3. Original Description \_\_\_\_\_ Vol. \_\_\_\_\_ Page \_\_\_\_\_ Where Recorded \_\_\_\_\_

4. Description of Corners:  
 Alum. tag on NW side of 6" tamarack.

5. Investigation Notes:

7. Photo Identification ~~\_\_\_\_\_~~  
 Photo No. ~~\_\_\_\_\_~~  
 Ident. By: ~~\_\_\_\_\_~~

8. Plane Coordinate Position Data ~~\_\_\_\_\_~~  
 State \_\_\_\_\_ Zone \_\_\_\_\_  
 X \_\_\_\_\_  
 Y \_\_\_\_\_  
 Estab. By \_\_\_\_\_  
 Field Book No. \_\_\_\_\_  
 Where Filed \_\_\_\_\_

9. Evaluation  
 Authentic \_\_\_\_\_  
 Needs Verif. \_\_\_\_\_ Monument \_\_\_\_\_  
 Re-estab. \_\_\_\_\_ Survey   
 Land Status \_\_\_\_\_

6. Signed [Signature] Title Forester Date 6/61

PERPETUATION RECORD

10. Monument:

11. Accessories

Field Book \_\_\_\_\_ Page \_\_\_\_\_

12. Set By \_\_\_\_\_ Title \_\_\_\_\_

License \_\_\_\_\_ Agency \_\_\_\_\_ Date \_\_\_\_\_

13. Recorded By \_\_\_\_\_ Volume \_\_\_\_\_ Page \_\_\_\_\_

(Agency)

(Date) \_\_\_\_\_ (City) \_\_\_\_\_ (County) \_\_\_\_\_ (State) \_\_\_\_\_

14. Remarks:

Index No. U 5  
(Alphabetical - Numerical)

LAND CORNER RECORD  
(RECTANGULAR SURVEYS)

T. 145 R. 28 5<sup>th</sup> Mer. N.F. Chippewa County Cass State Miss.  
5 1/4 Corner common to sections 29 & 30 and \_\_\_\_\_

EXISTING SURVEYS

**Original Government Survey**

Year surveyed \_\_\_\_\_

Original monument \_\_\_\_\_  
(Wood post, stone, pile of stones, pipe, etc.)

**Bearing Trees**

Species \_\_\_\_\_

Diameter \_\_\_\_\_

Bearing \_\_\_\_\_

Distance \_\_\_\_\_

**Original Evidence Found**

Year of search \_\_\_\_\_ By \_\_\_\_\_

Monument found \_\_\_\_\_

**Original Bearing Trees Found**

Species \_\_\_\_\_

Diameter \_\_\_\_\_

Bearing \_\_\_\_\_

Distance \_\_\_\_\_

**Subsequent Corner Restoration**

Year surveyed \_\_\_\_\_ By \_\_\_\_\_

Where filed or recorded \_\_\_\_\_

Monument \_\_\_\_\_  
(Original, concrete post, iron rod, etc.)

**Bearing Trees, Reference Objects**

Species \_\_\_\_\_

Diameter \_\_\_\_\_

Bearing \_\_\_\_\_

Distance \_\_\_\_\_

**Evidence of Subsequent Corner Restoration Found**

Year of search 6-21-68 By Morrison & Morgan  
1/4 mi SE side of 9" Spruce Appox  
corner has 25 ft 5/8" tag - Blue line  
painted N to E. This Appox corner established  
by compass & chaining from Appox corner  
1/4 mi N

Relation of Evidence to Record Features Along Section Lines

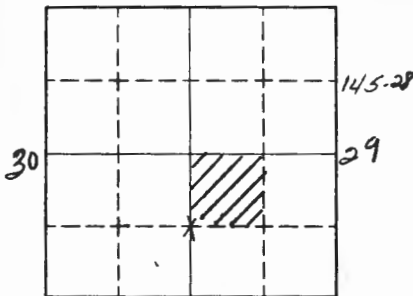

Sketch

○ Corner    ▨ F.S. Land

Section line to sections \_\_\_\_\_  
 Object \_\_\_\_\_  
 Record distance \_\_\_\_\_  
 Measured distance \_\_\_\_\_

Other Evidence

Describe evidence of use and occupation such as roads, fences, clearings, timber cutting lines, plantations, etc.. Cite source of testimony if any. \_\_\_\_\_  
 \_\_\_\_\_  
 \_\_\_\_\_  
 \_\_\_\_\_  
 \_\_\_\_\_

At time of search:

1. Did you have the record description?

Yes \_\_\_\_\_ No  \_\_\_\_\_

2. How was search area located?

~~Ranging~~, chaining, photos, maps, etc. \_\_\_\_\_  
 \_\_\_\_\_

3. Man hours spent in search   1  

4. Do you think additional search might recover evidence? Yes \_\_\_\_\_ No  \_\_\_\_\_

5. Signature J.M. Morrison

Perpetuation Record

Monument and accessories established. Include brief description of area. \_\_\_\_\_  
 \_\_\_\_\_  
 \_\_\_\_\_  
 \_\_\_\_\_  
 \_\_\_\_\_

Certified corner restoration certificate prepared: Yes \_\_\_\_\_ No \_\_\_\_\_

Filed in county records of \_\_\_\_\_ Date \_\_\_\_\_ County Document No. \_\_\_\_\_

Identified on aerial photo No. \_\_\_\_\_ Which is filed at \_\_\_\_\_

Index No. 4-6  
(Alphabetical - Numerical)

LAND CORNER RECORD  
(RECTANGULAR SURVEYS)

T. 145 R. 28 5<sup>th</sup> Mer. N.F. Chippewa County Cass State Miss  
1/4 Corner in center SW 1/4 Corner common to sections 29 and \_\_\_\_\_

EXISTING SURVEYS

**Original Government Survey**

Year surveyed \_\_\_\_\_

Original monument \_\_\_\_\_  
(Wood post, stone, pile of stones, pipe, etc.)

**Bearing Trees**

Species \_\_\_\_\_

Diameter \_\_\_\_\_

Bearing \_\_\_\_\_

Distance \_\_\_\_\_

**Original Evidence Found**

Year of search \_\_\_\_\_ By \_\_\_\_\_

Monument found \_\_\_\_\_

**Original Bearing Trees Found**

Species \_\_\_\_\_

Diameter \_\_\_\_\_

Bearing \_\_\_\_\_

Distance \_\_\_\_\_

**Subsequent Corner Restoration**

Year surveyed \_\_\_\_\_ By \_\_\_\_\_

Where filed or recorded \_\_\_\_\_

Monument \_\_\_\_\_  
(Original, concrete post, iron rod, etc.)

**Bearing Trees, Reference Objects**

Species \_\_\_\_\_

Diameter \_\_\_\_\_

Bearing \_\_\_\_\_

Distance \_\_\_\_\_

**Evidence of Subsequent Corner Restoration Found**

Year of search 6-21-68 By Morrison Diergen  
Tag on side of 10" Birch approx  
corner line 3 ft SW of tag - Blue line  
pointed N-S-E-W to reestablish. Then  
approx corner established by compass  
between approx corners 3/4 mi S & 1/4 mi  
W.

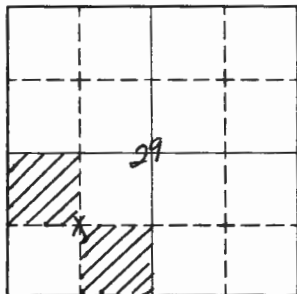

Sketch

○ Corner    ▨ F.S. Land

Relation of Evidence to Record Features Along Section Lines

Section line to sections \_\_\_\_\_  
 Object \_\_\_\_\_  
 Record distance \_\_\_\_\_  
 Measured distance \_\_\_\_\_

Other Evidence

Describe evidence of use and occupation such as roads, fences, clearings, timber cutting lines, plantations, etc.. Cite source of testimony if any. \_\_\_\_\_  
 \_\_\_\_\_  
 \_\_\_\_\_  
 \_\_\_\_\_

At time of search:

1. Did you have the record description?

Yes \_\_\_\_\_ No X

2. How was search area located?

~~By~~, chaining, photos, maps, etc. \_\_\_\_\_  
 \_\_\_\_\_

3. Man hours spent in search 1

4. Do you think additional search might recover evidence? Yes \_\_\_\_\_ No X

5. Signature S. B. Morrison

Perpetuation Record

Monument and accessories established. Include brief description of area. \_\_\_\_\_  
 \_\_\_\_\_  
 \_\_\_\_\_  
 \_\_\_\_\_

Certified corner restoration certificate prepared: Yes \_\_\_\_\_ No \_\_\_\_\_

Filed in county records at \_\_\_\_\_ Date \_\_\_\_\_ County Document No. \_\_\_\_\_

Identified on aerial photo No. \_\_\_\_\_ Which is filed at \_\_\_\_\_



Index No. 4 7  
(Alphabetical - Numerical)

LAND CORNER RECORD  
(RECTANGULAR SURVEYS)

T. 145 R. 28 Mer. N.F. Chippewa County Cass State Miss  
S 1/4 corner on N.S. Section corner common to sections 29 and \_\_\_\_\_

EXISTING SURVEYS

Original Government Survey	Original Evidence Found
Year surveyed _____	Year of search _____ By _____
Original monument _____ <small>(Wood post, stone, pile of stones, pipe, etc.)</small>	Monument found _____
Bearing Trees	Original Bearing Trees Found
Species _____	Species _____
Diameter _____	Diameter _____
Bearing _____	Bearing _____
Distance _____	Distance _____
Subsequent Corner Restoration	Evidence of Subsequent Corner Restoration Found
Year surveyed _____ By _____	Year of search <u>6-21-68</u> By <u>Morrison &amp; Morgan</u>
Where filed or recorded _____	<u>Tag on S side of 24" Red Pine - Approx</u>
Monument _____ <small>(Original, concrete post, iron rod, etc.)</small>	<u>corner line 55 ft E of Tag. Blue line</u>
_____	<u>pointed W - This Approx corner</u>
_____	<u>established by Compass &amp; Chaining from</u>
_____	<u>Approx Corner 1/4 mi W.</u>
Bearing Trees, Reference Objects	_____
Species _____	_____
Diameter _____	_____
Bearing _____	_____
Distance _____	_____

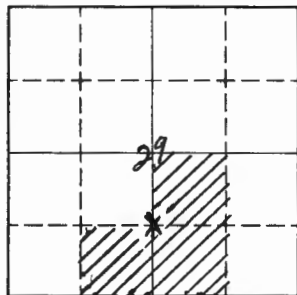

Sketch

○ Corner    ▨ F.S. Land

Relation of Evidence to Record Features Along Section Lines

Section line to sections \_\_\_\_\_  
 Object \_\_\_\_\_  
 Record distance \_\_\_\_\_  
 Measured distance \_\_\_\_\_

Other Evidence

Describe evidence of use and occupation such as roads, fences, clearings, timber cutting lines, plantations, etc.. Cite source of testimony if any. \_\_\_\_\_  
 \_\_\_\_\_  
 \_\_\_\_\_  
 \_\_\_\_\_

At time of search:

1. Did you have the record description?

Yes \_\_\_\_\_ No X \_\_\_\_\_

2. How was search area located?

~~Ranging~~, chaining, photos, maps, etc. \_\_\_\_\_  
 \_\_\_\_\_

3. Man hours spent in search 1

4. Do you think additional search might recover evidence? Yes \_\_\_\_\_ No X \_\_\_\_\_

5. Signature J. W. Morrison

Perpetuation Record

Monument and accessories established. Include brief description of area. \_\_\_\_\_  
 \_\_\_\_\_  
 \_\_\_\_\_  
 \_\_\_\_\_

Certified corner restoration certificate prepared: Yes \_\_\_\_\_ No \_\_\_\_\_

Filed in county records of \_\_\_\_\_ Date \_\_\_\_\_ County Document No. \_\_\_\_\_

Identified on aerial photo No. \_\_\_\_\_ Which is filed at \_\_\_\_\_

Index No. U 12  
(Alphabetical - Numerical)

LAND CORNER RECORD  
(RECTANGULAR SURVEYS)

RS-5800-11 (5/12/61)

T. 14S R. 28 5th Mer. N.F. Chippewa County Cass State Missouri  
Hub Corner in Center of SE 1/4 Corner common to sections 28 and \_\_\_\_\_

EXISTING SURVEYS

**Original Government Survey**

Year surveyed \_\_\_\_\_

Original monument \_\_\_\_\_  
(Wood post, stone, pile of stones, pipe, etc.)

**Bearing Trees**

Species \_\_\_\_\_

Diameter \_\_\_\_\_

Bearing \_\_\_\_\_

Distance \_\_\_\_\_

**Original Evidence Found**

Year of search \_\_\_\_\_ By \_\_\_\_\_

Monument found \_\_\_\_\_

**Original Bearing Trees Found**

Species \_\_\_\_\_

Diameter \_\_\_\_\_

Bearing \_\_\_\_\_

Distance \_\_\_\_\_

**Subsequent Corner Restoration**

Year surveyed \_\_\_\_\_ By \_\_\_\_\_

Where filed or recorded \_\_\_\_\_

Monument \_\_\_\_\_  
(Original, concrete post, iron rod, etc.)

**Bearing Trees, Reference Objects**

Species \_\_\_\_\_

Diameter \_\_\_\_\_

Bearing \_\_\_\_\_

Distance \_\_\_\_\_

**Evidence of Subsequent Corner Restoration Found**

Year of search 6-25-68 By Morrison & Kist  
log on W. side of 4" maple and is  
approx. corner. Blue dia painted S+E  
to swamp edge. This approx corner  
established by Compiss & Channing  
from approx corner 1/4 mi S.

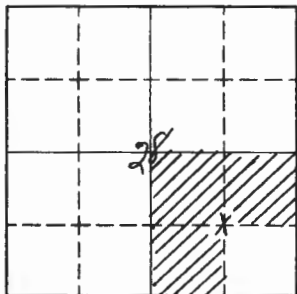

Sketch

○ Corner    ▨ F.S. Land

Relation of Evidence to Record Features Along Section Lines

Section line to sections \_\_\_\_\_  
 Object \_\_\_\_\_  
 Record distance \_\_\_\_\_  
 Measured distance \_\_\_\_\_

Other Evidence

Describe evidence of use and occupation such as roads, fences, clearings, timber cutting lines, plantations, etc.. Cite source of testimony if any. \_\_\_\_\_  
 \_\_\_\_\_  
 \_\_\_\_\_  
 \_\_\_\_\_

At time of search:

1. Did you have the record description?

Yes \_\_\_\_\_ No X \_\_\_\_\_

2. How was search area located?

~~Bying~~, chaining, photos, maps, etc. \_\_\_\_\_  
 \_\_\_\_\_

3. Man hours spent in search 1 \_\_\_\_\_

4. Do you think additional search might recover evidence? Yes \_\_\_\_\_ No X \_\_\_\_\_

5. Signature J.M. Morrison

Perpetuation Record

Monument and accessories established. Include brief description of area. \_\_\_\_\_  
 \_\_\_\_\_  
 \_\_\_\_\_  
 \_\_\_\_\_

Certified corner restoration certificate prepared: Yes \_\_\_\_\_ No \_\_\_\_\_

Filed in county records at \_\_\_\_\_ Date \_\_\_\_\_ County Document No. \_\_\_\_\_

Identified on aerial photo No. \_\_\_\_\_ Which is filed at \_\_\_\_\_

Index No. V 6  
 (Alphabetical - Numerical)

LAND CORNER RECORD  
 (RECTANGULAR SURVEYS)

RD-9680-11 (5/12/61)

T. 145 R. 28 5th Mer. N.F. Chippewa County Cass State Missouri  
W 1/4 Corner common to sections 29 & 32 and

EXISTING SURVEYS

Original Government Survey

Year surveyed \_\_\_\_\_  
 Original monument \_\_\_\_\_  
(Wood post, stone, pile of stones, pipe, etc.)

Bearing Trees

Species \_\_\_\_\_  
 Diameter \_\_\_\_\_  
 Bearing \_\_\_\_\_  
 Distance \_\_\_\_\_

Subsequent Corner Restoration

Year surveyed \_\_\_\_\_ By \_\_\_\_\_  
 Where filed or recorded \_\_\_\_\_  
 Monument \_\_\_\_\_  
(Original, concrete post, iron rod, etc.)

Bearing Trees, Reference Objects

Species \_\_\_\_\_  
 Diameter \_\_\_\_\_  
 Bearing \_\_\_\_\_  
 Distance \_\_\_\_\_

Original Evidence Found

Year of search \_\_\_\_\_ By \_\_\_\_\_  
 Monument found \_\_\_\_\_

Original Bearing Trees Found

Species \_\_\_\_\_  
 Diameter \_\_\_\_\_  
 Bearing \_\_\_\_\_  
 Distance \_\_\_\_\_

Evidence of Subsequent Corner Restoration Found

Year of search 6-21-68 By Morrison & Morgan  
Tag on S side of 9" Spruce and is  
Approx Corner. Blue line painted N + S. -  
this Approx Corner established by Compass  
& Chaining from Sec Corner. 3/4 mile. which  
is a good corner and by correlation with  
Corners to the N + S. This tag originally put  
up in 1959 by Christopher and Morrison & was  
3 ch N of present location. It was moved to  
better fit in with existing corners to the  
N + S.

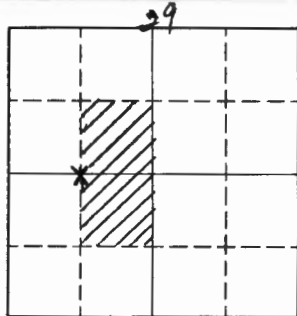

○ Corner    ▨ F.S. Land

Relation of Evidence to Record Features Along Section Lines

Section line to sections \_\_\_\_\_  
 Object \_\_\_\_\_  
 Record distance \_\_\_\_\_  
 Measured distance \_\_\_\_\_

Other Evidence

Describe evidence of use and occupation such as roads, fences, clearings, timber cutting lines, plantations, etc.. Cite source of testimony if any. \_\_\_\_\_  
 \_\_\_\_\_  
 \_\_\_\_\_  
 \_\_\_\_\_  
 \_\_\_\_\_

At time of search:

1. Did you have the record description?

Yes \_\_\_\_\_ No X

2. How was search area located?

~~Recon~~, chaining, photos, maps, etc. \_\_\_\_\_  
 \_\_\_\_\_  
 \_\_\_\_\_

3. Man hours spent in search 1

4. Do you think additional search might recover evidence? Yes \_\_\_\_\_ No X

5. Signature J. M. Morrison

Perpetuation Record

Monument and accessories established. Include brief description of area. \_\_\_\_\_  
 \_\_\_\_\_  
 \_\_\_\_\_  
 \_\_\_\_\_  
 \_\_\_\_\_

Certified corner restoration certificate prepared: Yes \_\_\_\_\_ No \_\_\_\_\_

Filed in county records at \_\_\_\_\_ Date \_\_\_\_\_ County Document No. \_\_\_\_\_

Identified on aerial photo No. \_\_\_\_\_ Which is filed at \_\_\_\_\_

Index No. V-9  
(Alphabetical - Numerical)

BOOK # 1  
PAGE # 32  
5<sup>th</sup>

LAND CORNER RECORD  
(RECTANGULAR SURVEYS)

T. 145 R. 28 Mer. N.F. Chippewa County Cross State Minnesota  
Section Corner common to sections 28, 29, 32 and 33

EXISTING SURVEYS

**Original Government Survey**

Year surveyed \_\_\_\_\_

Original monument \_\_\_\_\_  
(Wood post, stone, pile of stones, pipe, etc.)

Species Needle Bearing Trees cut!

Diameter \_\_\_\_\_

Bearing \_\_\_\_\_

Distance \_\_\_\_\_

**Original Evidence Found**

Year of search \_\_\_\_\_ By \_\_\_\_\_

Monument found \_\_\_\_\_

**Original Bearing Trees Found**

Species \_\_\_\_\_

Diameter \_\_\_\_\_

Bearing \_\_\_\_\_

Distance \_\_\_\_\_

**Subsequent Corner Restoration**

Year surveyed \_\_\_\_\_ By \_\_\_\_\_

Where filed or recorded \_\_\_\_\_

Monument \_\_\_\_\_  
(Original, concrete post, iron rod, etc.)

**Bearing Trees, Reference Objects**

Species \_\_\_\_\_

Diameter \_\_\_\_\_

Bearing \_\_\_\_\_

Distance \_\_\_\_\_

**Evidence of Subsequent Corner Restoration Found**

Year of search 6-25-68 By Morrison

Tag on N side of 18" Red Pine approx  
Corner is an iron pipe (with brass cap)  
which lies 14 lbs N. 20° E from tag.  
Another tag 2 1/2 ch N on Boulder Hill  
tower road.

Old notes indicate 2 B.T. @ this  
location. We did not have notes with  
us and did not see the B.T.

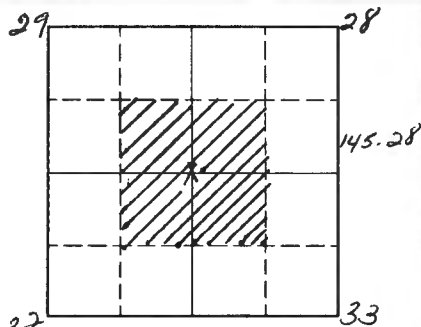

Sketch

○ Corner    ▨ F.S. Land

Relation of Evidence to Record Features Along Section Lines

Section line to sections \_\_\_\_\_  
 Object \_\_\_\_\_  
 Record distance \_\_\_\_\_  
 Measured distance \_\_\_\_\_

Other Evidence

Describe evidence of use and occupation such as roads, fences, clearings, timber cutting lines, plantations, etc.. Cite source of testimony if any. \_\_\_\_\_

At time of search:

1. Did you have the record description?  
 Yes \_\_\_\_\_ No X

2. How was search area located?  
~~Peering~~, chaining, photos, maps, etc. \_\_\_\_\_

3. Man hours spent in search 1

4. Do you think additional search might recover evidence? Yes \_\_\_\_\_ No X

5. Signature S. M. Morrison

Perpetuation Record

Monument and accessories established. Include brief description of area. \_\_\_\_\_

Certified corner restoration certificate prepared: Yes \_\_\_\_\_ No \_\_\_\_\_

Filed in county records at \_\_\_\_\_ Date \_\_\_\_\_ County Document No. \_\_\_\_\_

Identified on aerial photo No. \_\_\_\_\_ Which is filed at \_\_\_\_\_



Index No. V 11  
(Alphabetical - Numerical)

*BOOK # 1*  
*PAGE # 33*

LAND CORNER RECORD  
(RECTANGULAR SURVEYS)

T. 145 R. 28 Mer. N.F. Chippewa County Cass State Missouri  
14 Corner common to sections 28, 33 and \_\_\_\_\_

EXISTING SURVEYS

**Original Government Survey**

Year surveyed \_\_\_\_\_

Original monument \_\_\_\_\_  
(Wood post, stone, pile of stones, pipe, etc.)

Species Woods Bearing Trees etc.

Diameter \_\_\_\_\_

Bearing \_\_\_\_\_

Distance \_\_\_\_\_

**Original Evidence Found**

Year of search \_\_\_\_\_ By \_\_\_\_\_

Monument found \_\_\_\_\_

**Original Bearing Trees Found**

Species \_\_\_\_\_

Diameter \_\_\_\_\_

Bearing \_\_\_\_\_

Distance \_\_\_\_\_

**Subsequent Corner Restoration**

Year surveyed \_\_\_\_\_ By \_\_\_\_\_

Where filed or recorded \_\_\_\_\_

Monument \_\_\_\_\_  
(Original, concrete post, iron rod, etc.)

**Bearing Trees, Reference Objects**

Species \_\_\_\_\_

Diameter \_\_\_\_\_

Bearing \_\_\_\_\_

Distance \_\_\_\_\_

**Evidence of Subsequent Corner Restoration Found**

Year of search 6-24-68 By Morrison + Morgan  
Tag on NW side of 26" Red line  
Approx corner consists of a squared  
stake which lies 29 lbs W of tag.  
Another tag on woods road 5 1/2 lbs E.  
This approx corner located by compass  
+ chaining from tag on road

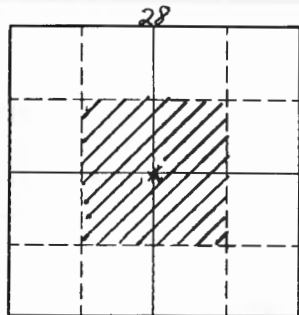

33  
Sketch

○ Corner    ▨ F.S. Land

Relation of Evidence to Record Features Along Section Lines

Section line to sections \_\_\_\_\_  
 Object \_\_\_\_\_  
 Record distance \_\_\_\_\_  
 Measured distance \_\_\_\_\_

Other Evidence

Describe evidence of use and occupation such as roads, fences, clearings, timber cutting lines, plantations, etc.. Cite source of testimony if any. \_\_\_\_\_  
 \_\_\_\_\_  
 \_\_\_\_\_

At time of search:

1. Did you have the record description?

Yes \_\_\_\_\_ No X

2. How was search area located?

~~Placing~~, chaining, photos, maps, etc. \_\_\_\_\_  
 \_\_\_\_\_

3. Man hours spent in search 1

4. Do you think additional search might recover evidence? Yes \_\_\_\_\_ No X

5. Signature L. M. Morrison

Perpetuation Record

Monument and accessories established. Include brief description of area. \_\_\_\_\_  
 \_\_\_\_\_  
 \_\_\_\_\_

Certified corner restoration certificate prepared: Yes \_\_\_\_\_ No \_\_\_\_\_

Filed in county records at \_\_\_\_\_ Date \_\_\_\_\_ County Document No. \_\_\_\_\_

Identified on aerial photo No. \_\_\_\_\_ Which is filed at \_\_\_\_\_

Index No. V 12  
(Alphabetical - Numerical)

LAND CORNER RECORD  
(RECTANGULAR SURVEYS)

NS-5680-11 (5/12/61)

T. 145 R. 28 5<sup>th</sup> Mer. N.F. Chippewa County Cass State Missouri  
E 1/4 Corner common to sections 28, 33, and

EXISTING SURVEYS

**Original Government Survey**

Year surveyed \_\_\_\_\_

Original monument \_\_\_\_\_  
(Wood post, stone, pile of stones, pipe, etc.)

**Bearing Trees**

Species \_\_\_\_\_

Diameter \_\_\_\_\_

Bearing \_\_\_\_\_

Distance \_\_\_\_\_

**Original Evidence Found**

Year of search \_\_\_\_\_ By \_\_\_\_\_

Monument found \_\_\_\_\_

**Original Bearing Trees Found**

Species \_\_\_\_\_

Diameter \_\_\_\_\_

Bearing \_\_\_\_\_

Distance \_\_\_\_\_

**Subsequent Corner Restoration**

Year surveyed \_\_\_\_\_ By \_\_\_\_\_

Where filed or recorded \_\_\_\_\_

Monument \_\_\_\_\_  
(Original, concrete post, iron rod, etc.)

**Bearing Trees, Reference Objects**

Species \_\_\_\_\_

Diameter \_\_\_\_\_

Bearing \_\_\_\_\_

Distance \_\_\_\_\_

**Evidence of Subsequent Corner Restoration Found**

Year of search 6-25-68 By Morrison & Kirt  
log on W. side of 12" Tansrock  
and is approx corner. Blue line  
projected E to swamp edge & North.  
This approx corner established by compass  
& chaining from approx corner 1/4 mi W-  
and by correction of old blazed lines.

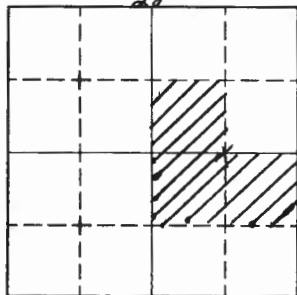

33  
Sketch

○ Corner    ▨ F.S. Land

Relation of Evidence to Record Features Along Section Lines

Section line to sections \_\_\_\_\_  
 Object \_\_\_\_\_  
 Record distance \_\_\_\_\_  
 Measured distance \_\_\_\_\_

Other Evidence

Describe evidence of use and occupation such as roads, fences, clearings, timber cutting lines, plantations, etc.. Cite source of testimony if any. \_\_\_\_\_  
 \_\_\_\_\_  
 \_\_\_\_\_  
 \_\_\_\_\_

At time of search:

1. Did you have the record description?

Yes \_\_\_\_\_ No X \_\_\_\_\_

2. How was search area located?

Reconing, chaining, photos, maps, etc. \_\_\_\_\_  
 \_\_\_\_\_

3. Man hours spent in search 1

4. Do you think additional search might recover evidence? Yes \_\_\_\_\_ No X \_\_\_\_\_

5. Signature J. M. Morrison

Perpetuation Record

Monument and accessories established. Include brief description of area. \_\_\_\_\_  
 \_\_\_\_\_  
 \_\_\_\_\_  
 \_\_\_\_\_

Certified corner restoration certificate prepared: Yes \_\_\_\_\_ No \_\_\_\_\_

Filed in county records at \_\_\_\_\_ Date \_\_\_\_\_ County Document No. \_\_\_\_\_

Identified on aerial photo No. \_\_\_\_\_ Which is filed at \_\_\_\_\_

T. 145 R. 28 S. 5 Mer. N.F. Chippewa County Cal State Wn  
N 24 Corner common to sections 34 and \_\_\_\_\_

## EXISTING SURVEYS

## Original Government Survey

Year surveyed 1873  
Original monument wood post  
(Wood post, stone, pile of stones, pipe, etc.)

## Bearing Trees

Species \_\_\_\_\_  
Diameter \_\_\_\_\_  
Bearing \_\_\_\_\_  
Distance \_\_\_\_\_

## Subsequent Corner Restoration

Year surveyed \_\_\_\_\_ By \_\_\_\_\_  
Where filed or recorded \_\_\_\_\_  
Monument \_\_\_\_\_  
(Original, concrete post, iron rod, etc.)

## Bearing Trees, Reference Objects

Species \_\_\_\_\_  
Diameter \_\_\_\_\_  
Bearing \_\_\_\_\_  
Distance \_\_\_\_\_

## Original Evidence Found

Year of search \_\_\_\_\_ By \_\_\_\_\_  
Monument found \_\_\_\_\_

## Original Bearing Trees Found

Species \_\_\_\_\_  
Diameter \_\_\_\_\_  
Bearing \_\_\_\_\_  
Distance \_\_\_\_\_

## Evidence of Subsequent Corner Restoration Found

Year of search 1982 By Hary Stevenson  
found downed wood post with post point  
on ground. set Cass Co cast iron monument  
of 3 new BT's

## Bearing Trees, Reference Objects

Bearing Trees, Reference Objects		
<u>Jackpine</u>	<u>N Pine</u>	<u>N Pine</u>
<u>5"</u>	<u>18"</u>	<u>16"</u>
<u>N49E</u>	<u>S82W</u>	<u>S21W</u>
<u>15.69'</u>	<u>39.12'</u>	<u>71.22'</u>

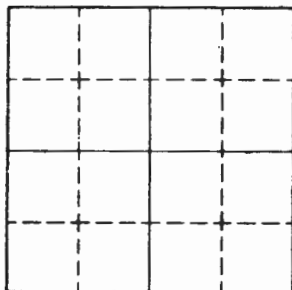

Sketch

Corner  F.S. Land

At time of search:

1. Did you have the record description?

Yes \_\_\_\_\_ No \_\_\_\_\_

2. How was search area located?

Pacing, chaining, photos, maps,  
etc. \_\_\_\_\_

3. Man hours spent in search \_\_\_\_\_

4. Do you think additional search might  
recover evidence? Yes \_\_\_\_\_ No \_\_\_\_\_

5. Signature \_\_\_\_\_

Relation of Evidence to Record Features Along Section Lines

Section line to sections \_\_\_\_\_  
Object \_\_\_\_\_  
Record distance \_\_\_\_\_  
Measured distance \_\_\_\_\_

Other Evidence

Describe evidence of use and occupation such as roads, fences, clearings, timber cutting lines, plantations, etc.. Cite source of testimony if any. \_\_\_\_\_

Perpetuation Record

Monument and accessories established. Include brief description of area. \_\_\_\_\_

**CERTIFICATE FILED**

Certified corner restoration certificate prepared by Gary Stevenson Yes \_\_\_\_\_ No \_\_\_\_\_  
Filed in county records at Call Date 12/2/82 County Document No. 263908  
Identified on aerial photo No. \_\_\_\_\_ Which is filed at \_\_\_\_\_

Index No. V-17  
(Alphabetical - Numerical)LAND CORNER RECORD  
(RECTANGULAR SURVEYS)R9-7150-4 (Rev. 6/13/67)  
GPO 802-127T. 145 R. 28 S. Mer. N.F. Chippewa County Cass State MN  
NE Corner common to sections 34 and \_\_\_\_\_

## EXISTING SURVEYS

## Original Government Survey

Year surveyed 1873  
Original monument wood post  
(Wood post, stone, pile of stones, pipe, etc.)

## Bearing Trees

Species \_\_\_\_\_  
Diameter \_\_\_\_\_  
Bearing \_\_\_\_\_  
Distance \_\_\_\_\_

## Subsequent Corner Restoration

Year surveyed \_\_\_\_\_ By \_\_\_\_\_  
Where filed or recorded \_\_\_\_\_  
Monument \_\_\_\_\_  
(Original, concrete post, iron rod, etc.)

## Bearing Trees, Reference Objects

Species \_\_\_\_\_  
Diameter \_\_\_\_\_  
Bearing \_\_\_\_\_  
Distance \_\_\_\_\_

## Original Evidence Found

Year of search \_\_\_\_\_ By \_\_\_\_\_  
Monument found \_\_\_\_\_

## Original Bearing Trees Found

Species \_\_\_\_\_  
Diameter \_\_\_\_\_  
Bearing \_\_\_\_\_  
Distance \_\_\_\_\_

## Evidence of Subsequent Corner Restoration Found

Year of search 1982 By Dary Stenerson  
No monument found. Used 1906 Plot  
of Bena to establish new corner - set  
monument in Forest Road.

## Bearing Trees, Reference Objects

Bearing Trees, Reference Objects	
<u>Cedar</u>	<u>Cedar</u>
<u>7"</u>	<u>8"</u>
<u>S10°W</u>	<u>S40E</u>
<u>25.61'</u>	<u>41.00'</u>

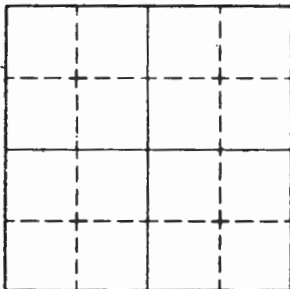

Sketch

Corner  F.S. Land

At time of search:

1. Did you have the record description?

Yes \_\_\_\_\_ No \_\_\_\_\_

2. How was search area located?

Pacing, chaining, photos, maps, etc. \_\_\_\_\_

3. Man hours spent in search \_\_\_\_\_

4. Do you think additional search

recover evidence? Yes \_\_\_\_\_ No \_\_\_\_\_

5. Signature \_\_\_\_\_

Relation of Evidence to Record Features Along Section Lines

Section line to sections \_\_\_\_\_  
Object \_\_\_\_\_  
Record distance \_\_\_\_\_  
Measured distance \_\_\_\_\_

Other Evidence

Describe evidence of use and occupation such as roads, fences, clearings, timber cutting lines, plantations, etc.. Cite source of testimony if any. \_\_\_\_\_

Perpetuation Record

Monument and accessories established. Include brief description of area. \_\_\_\_\_

**CERTIFICATE FILED**

Certified corner restoration certificate prepared:  Yes Gary Stevenson No \_\_\_\_\_  
Filed in county records at Cass Date 7/22/82 County Document No. 263901  
Identified on aerial photo No. \_\_\_\_\_ Which is filed at \_\_\_\_\_



See No. V-25  
(Alphabetical - Subscript)

LAND CORNER RECORD  
(RECTANGULAR SURVEYS)

RD-7 150-4 (Rev. 6/13/67)  
GPO 502-127

145N R. 28W 5<sup>th</sup> Mer. N.F. Chippewa County Ross State Minnesota  
Section Corner common to sections 30 31 T145N 25 and 36  
R27W T145N R28W

EXISTING SURVEYS

Original Government Survey

Year surveyed \_\_\_\_\_ By \_\_\_\_\_  
Original monument See original notes  
(Wood post, stone, pile of stones, pipe, etc.)

Bearing Trees

Species \_\_\_\_\_  
Diameter \_\_\_\_\_  
Bearing \_\_\_\_\_  
Distance \_\_\_\_\_

Subsequent Corner Restoration

Year surveyed \_\_\_\_\_ By \_\_\_\_\_  
Where filed or recorded \_\_\_\_\_  
Monument \_\_\_\_\_  
(Springer, concrete post, iron rod, etc.)

Bearing Trees, Reference Objects

Species \_\_\_\_\_  
Diameter \_\_\_\_\_  
Bearing \_\_\_\_\_  
Distance \_\_\_\_\_

Original Evidence Found

Year of search \_\_\_\_\_ By \_\_\_\_\_  
Monument found \_\_\_\_\_

Original Bearing Trees Found

Species \_\_\_\_\_  
Diameter \_\_\_\_\_  
Bearing \_\_\_\_\_  
Distance \_\_\_\_\_

Evidence of Subsequent Corner Restoration Found

Year of search \_\_\_\_\_ By \_\_\_\_\_  
\_\_\_\_\_  
\_\_\_\_\_  
\_\_\_\_\_

Bearing Trees, Reference Objects

Species \_\_\_\_\_  
Diameter \_\_\_\_\_  
Bearing \_\_\_\_\_  
Distance \_\_\_\_\_

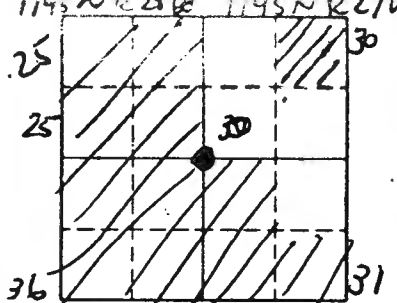

Sketch

O Corner F.S. Land

Relation of Evidence to Record Features Along Section Lines

Section line to sections \_\_\_\_\_

Object \_\_\_\_\_

Record distance \_\_\_\_\_

Measured distance \_\_\_\_\_

Other Evidence

Describe evidence of use and occupation such as roads, fences, clearings, timber cutting lines, plantations, etc.. Cite source of testimony if any. \_\_\_\_\_

time of search: \_\_\_\_\_

did you have the record description? \_\_\_\_\_

yes \_\_\_\_\_ No

How was search area located?  
 (circled) pacing, (circled) chaining, (circled) photos, (circled) maps, etc.

How many hours spent in search \_\_\_\_\_

Do you think additional search might discover evidence? Yes \_\_\_\_\_ No \_\_\_\_\_

Signature

Perpetuation Record

*Whitehorn/Olson*

Monument and accessories established. Include brief description of area. *9-10-81*  
 find 1912 John Curo IP & FS Tag on Tree on N side of Hwy 2. Pipe is 21 meters southw. of Powerline and referenced by: T145NR27W, BK 3, pp 6

<i>Twin White Oak</i>	<i>Red Oak</i>	<i>Red Pine</i>	<i>Red Pine</i>
<i>13cm x 8.5cm</i>	<i>18.8cm</i>	<i>11.5cm</i>	<i>25.8cm</i>
<i>N59°E</i>	<i>N86°E</i>	<i>S30°W</i>	<i>N69°W</i>
<i>17.55 meters</i>	<i>16.44m</i>	<i>17.11m</i>	<i>36.04m</i>

Certified corner restoration certificate prepared: Yes \_\_\_\_\_ No

Filed in county records at \_\_\_\_\_ Date \_\_\_\_\_ County Document No. \_\_\_\_\_

Identified on aerial photo No: \_\_\_\_\_ Which is filed at \_\_\_\_\_

Index No. W-2  
(Alphabetical - Numerical)

LAND CORNER RECORD  
(RECTANGULAR SURVEYS)

R9-7150-4 (Rev. 6/13/67)  
 GPO 806-924

T. 145 R. 28 5<sup>th</sup> Mer. N.F. Chippewa County Cook State Minnesota  
 Corner common to sections 10 1/4 31 and \_\_\_\_\_

EXISTING SURVEYS

Original Government Survey

Year surveyed \_\_\_\_\_  
 Original monument \_\_\_\_\_  
(Wood post, stone, pile of stones, pipe, etc.)

Bearing Trees

Species \_\_\_\_\_  
 Diameter \_\_\_\_\_  
 Bearing \_\_\_\_\_  
 Distance \_\_\_\_\_

Subsequent Corner Restoration

Year surveyed \_\_\_\_\_ By \_\_\_\_\_  
 Where filed or recorded \_\_\_\_\_  
 Monument \_\_\_\_\_  
(Original, concrete post, iron rod, etc.)

Bearing Trees, Reference Objects

Species \_\_\_\_\_  
 Diameter \_\_\_\_\_  
 Bearing \_\_\_\_\_  
 Distance \_\_\_\_\_

Original Evidence Found

Year of search \_\_\_\_\_ By \_\_\_\_\_  
 Monument found \_\_\_\_\_

Original Bearing Trees Found

Species \_\_\_\_\_  
 Diameter \_\_\_\_\_  
 Bearing \_\_\_\_\_  
 Distance \_\_\_\_\_

Evidence of Subsequent Corner Restoration Found

Year of search 11-29-69 By Morrison & Pete Jagne  
Tag on N. side of 10" birch - approx corner lies  
5ft SW of tag - blue line painted N & S.  
No brass cap or B.T's - tag approx corner  
established by Compass & Chaining between  
an approx corner 1/4 mi N. and a good corner  
1/4 mi South. Bearing Trees, Reference Objects

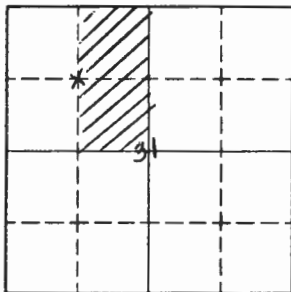

Sketch

○ Corner    ▨ F.S. Land

Relation of Evidence to Record Features Along Section Lines

Section line to sections \_\_\_\_\_  
 Object \_\_\_\_\_  
 Record distance \_\_\_\_\_  
 Measured distance \_\_\_\_\_

Other Evidence

Describe evidence of use and occupation such as roads, fences, clearings, timber cutting lines, plantations, etc.. Cite source of testimony if any. \_\_\_\_\_

At time of search:

1. Did you have the record description?

Yes \_\_\_\_\_ No

2. How was search area located?

~~Photos~~, chaining, photos, maps, etc. \_\_\_\_\_

3. Man hours spent in search 1

4. Do you think additional search might recover evidence? Yes \_\_\_\_\_ No

5. Signature J. Morrison

Perpetuation Record

Monument and accessories established. Include brief description of area. \_\_\_\_\_

Certified corner restoration certificate prepared: Yes \_\_\_\_\_ No \_\_\_\_\_

Filed in county records at \_\_\_\_\_ Date \_\_\_\_\_ County Document No. \_\_\_\_\_

Identified on aerial photo No. \_\_\_\_\_ Which is filed at \_\_\_\_\_

Index No. W 9  
(Alphabetical - Numerical)

LAND CORNER RECORD  
(RECTANGULAR SURVEYS)

RS-5680-11 (5/12/61)

T. 145 R. 28 5<sup>th</sup> Mer. N.F. Chippewa County Cass State Minn  
N 1/4 Corner common to sections 32 33 and

EXISTING SURVEYS

**Original Government Survey**

Year surveyed \_\_\_\_\_  
 Original monument \_\_\_\_\_  
(Wood post, stone, pile of stones, pipe, etc.)

**Bearing Trees**

Species \_\_\_\_\_  
 Diameter \_\_\_\_\_  
 Bearing \_\_\_\_\_  
 Distance \_\_\_\_\_

**Original Evidence Found**

Year of search \_\_\_\_\_ By \_\_\_\_\_  
 Monument found \_\_\_\_\_

**Original Bearing Trees Found**

Species \_\_\_\_\_  
 Diameter \_\_\_\_\_  
 Bearing \_\_\_\_\_  
 Distance \_\_\_\_\_

**Subsequent Corner Restoration**

Year surveyed \_\_\_\_\_ By \_\_\_\_\_  
 Where filed or recorded \_\_\_\_\_  
 Monument \_\_\_\_\_  
(Original, concrete post, iron rod, etc.)

**Bearing Trees, Reference Objects**

Species \_\_\_\_\_  
 Diameter \_\_\_\_\_  
 Bearing \_\_\_\_\_  
 Distance \_\_\_\_\_

**Evidence of Subsequent Corner Restoration Found**

Year of search 6-25-68 By Morrison + Morgan  
lag on E side of 5" maple and is  
approx corner blue line painted E 6 S.  
this approx corner established by  
compass + chaining from a good corner  
1/4 mi N - another lag on woods road 2  
ch 5

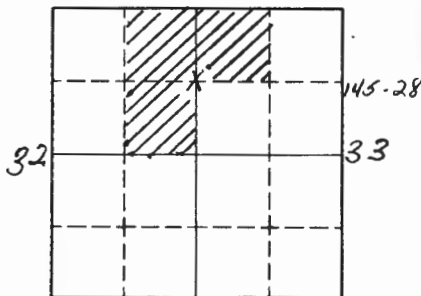

Sketch

○ Corner    ▨ F.S. Land

Relation of Evidence to Record Features Along Section Lines

Section line to sections \_\_\_\_\_  
 Object \_\_\_\_\_  
 Record distance \_\_\_\_\_  
 Measured distance \_\_\_\_\_

Other Evidence

Describe evidence of use and occupation such as roads, fences, clearings, timber cutting lines, plantations, etc.. Cite source of testimony if any. \_\_\_\_\_  
 \_\_\_\_\_  
 \_\_\_\_\_  
 \_\_\_\_\_

At time of search:

1. Did you have the record description?

Yes \_\_\_\_\_ No X

2. How was search area located?

~~Records~~, chaining, photos, maps, etc. \_\_\_\_\_  
 \_\_\_\_\_

3. Man hours spent in search 1

4. Do you think additional search might recover evidence? Yes \_\_\_\_\_ No X

5. Signature J.M. Morrison

Perpetuation Record

Monument and accessories established. Include brief description of area. \_\_\_\_\_  
 \_\_\_\_\_  
 \_\_\_\_\_  
 \_\_\_\_\_

Certified corner restoration certificate prepared: Yes \_\_\_\_\_ No \_\_\_\_\_

Filed in county records at \_\_\_\_\_ Date \_\_\_\_\_ County Document No. \_\_\_\_\_

Identified on aerial photo No. \_\_\_\_\_ Which is filed at \_\_\_\_\_

Index No. W 10  
(Alphabetical - Numerical)

LAND CORNER RECORD  
(RECTANGULAR SURVEYS)

RS-5680-11 (5/12/61)

T. 145 R. 28 5th Mer. N.F. Chippewa County Cass State Miss  
1/4 corner in center of NW 1/4 Corner common to sections 39 and \_\_\_\_\_

EXISTING SURVEYS

Original Government Survey

Year surveyed \_\_\_\_\_  
 Original monument \_\_\_\_\_  
(Wood post, stone, pile of stones, pipe, etc.)

Bearing Trees

Species \_\_\_\_\_  
 Diameter \_\_\_\_\_  
 Bearing \_\_\_\_\_  
 Distance \_\_\_\_\_

Subsequent Corner Restoration

Year surveyed \_\_\_\_\_ By \_\_\_\_\_  
 Where filed or recorded \_\_\_\_\_  
 Monument \_\_\_\_\_  
(Original, concrete post, iron rod, etc.)

Bearing Trees, Reference Objects

Species \_\_\_\_\_  
 Diameter \_\_\_\_\_  
 Bearing \_\_\_\_\_  
 Distance \_\_\_\_\_

Original Evidence Found

Year of search \_\_\_\_\_ By \_\_\_\_\_  
 Monument found \_\_\_\_\_

Original Bearing Trees Found

Species \_\_\_\_\_  
 Diameter \_\_\_\_\_  
 Bearing \_\_\_\_\_  
 Distance \_\_\_\_\_

Evidence of Subsequent Corner Restoration Found

Year of search 6-24-68 By Morrison & Morgan  
tag on SE side of 5" Tamarack  
Apprx. corner is an old squared stake  
which lies 8 ft SE of tag. Blue line  
pointed E & W. This Apprx. corner  
located by compass & chaining from  
Apprx. corner 1/4 mi W.

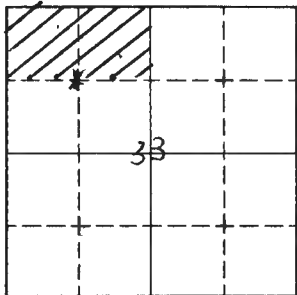

Sketch

○ Corner    ▨ F.S. Land

Relation of Evidence to Record Features Along Section Lines

Section line to sections \_\_\_\_\_  
 Object \_\_\_\_\_  
 Record distance \_\_\_\_\_  
 Measured distance \_\_\_\_\_

Other Evidence

Describe evidence of use and occupation such as roads, fences, clearings, timber cutting lines, plantations, etc.. Cite source of testimony if any. \_\_\_\_\_  
 \_\_\_\_\_  
 \_\_\_\_\_  
 \_\_\_\_\_  
 \_\_\_\_\_

At time of search:

1. Did you have the record description?

Yes \_\_\_\_\_ No X

2. How was search area located?

Roaming, chaining, photos, maps, etc. \_\_\_\_\_  
 \_\_\_\_\_

3. Man hours spent in search 1

4. Do you think additional search might recover evidence? Yes \_\_\_\_\_ No X

5. Signature J. M. Morrison

Perpetuation Record

Monument and accessories established. Include brief description of area. \_\_\_\_\_  
 \_\_\_\_\_  
 \_\_\_\_\_  
 \_\_\_\_\_  
 \_\_\_\_\_

Certified corner restoration certificate prepared: Yes \_\_\_\_\_ No \_\_\_\_\_

Filed in county records at \_\_\_\_\_ Date \_\_\_\_\_ County Document No. \_\_\_\_\_

Identified on aerial photo No. \_\_\_\_\_ Which is filed at \_\_\_\_\_



Index No. X 6  
(Alphabetical - Numerical)

LAND CORNER RECORD  
(RECTANGULAR SURVEYS)

RS-5680-11 15/12/61

T. 145 R. 28 5th Mer. N.F. Chippewa County Ohio State Ohio  
W 1/4 corner on E-W line Corner common to sections 32 and \_\_\_\_\_

EXISTING SURVEYS

Original Government Survey

Year surveyed \_\_\_\_\_  
 Original monument \_\_\_\_\_  
(Wood post, stone, pile of stones, pipe, etc.)

Bearing Trees

Species \_\_\_\_\_  
 Diameter \_\_\_\_\_  
 Bearing \_\_\_\_\_  
 Distance \_\_\_\_\_

Original Evidence Found

Year of search \_\_\_\_\_ By \_\_\_\_\_  
 Monument found \_\_\_\_\_

Original Bearing Trees Found

Species \_\_\_\_\_  
 Diameter \_\_\_\_\_  
 Bearing \_\_\_\_\_  
 Distance \_\_\_\_\_

Subsequent Corner Restoration

Year surveyed \_\_\_\_\_ By \_\_\_\_\_  
 Where filed or recorded \_\_\_\_\_  
 Monument \_\_\_\_\_  
(Original, concrete post, iron rod, etc.)

Bearing Trees, Reference Objects

Species \_\_\_\_\_  
 Diameter \_\_\_\_\_  
 Bearing \_\_\_\_\_  
 Distance \_\_\_\_\_

Evidence of Subsequent Corner Restoration Found

Year of search 6-20-68 By Morrison + Morgan  
Tag on E side of 7" Tamarack - Corner  
is on a square plate which lies  
S. 75° E - 38 ft - Blue line painted  
N @ this time and blue line painted  
W 1/5 - This corner apparently established  
in 1941

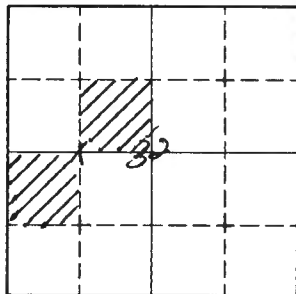

Sketch

○ Corner    ▨ F.S. Land

Relation of Evidence to Record Features Along Section Lines

Section line to sections \_\_\_\_\_  
 Object \_\_\_\_\_  
 Record distance \_\_\_\_\_  
 Measured distance \_\_\_\_\_

Other Evidence

Describe evidence of use and occupation such as roads, fences, clearings, timber cutting lines, plantations, etc.. Cite source of testimony if any. \_\_\_\_\_  
 \_\_\_\_\_  
 \_\_\_\_\_  
 \_\_\_\_\_  
 \_\_\_\_\_

At time of search:

1. Did you have the record description?

Yes \_\_\_\_\_ No X \_\_\_\_\_

2. How was search area located?

Reasing, chaining, photos, maps, etc. \_\_\_\_\_  
 \_\_\_\_\_

3. Man hours spent in search 1

4. Do you think additional search might recover evidence? Yes \_\_\_\_\_ No X \_\_\_\_\_

5. Signature J. M. Morrison

Perpetuation Record

Monument and accessories established. Include brief description of area. \_\_\_\_\_  
 \_\_\_\_\_  
 \_\_\_\_\_  
 \_\_\_\_\_  
 \_\_\_\_\_  
 \_\_\_\_\_

Certified corner restoration certificate prepared: Yes \_\_\_\_\_ No \_\_\_\_\_

Filed in county records at \_\_\_\_\_ Date \_\_\_\_\_ County Document No. \_\_\_\_\_

Identified on aerial photo No. \_\_\_\_\_ Which is filed at \_\_\_\_\_

Index No. X 13  
(Alphabetical - Numerical)Book #1  
Page #34LAND CORNER RECORD  
(RECTANGULAR SURVEYS)

RS-9680-11 (5/12/81)

T. 145 R. 28 Mer. N.F. 5th Chippewa County Cass State Miss  
14 Corner common to sections 33 and 34

## EXISTING SURVEYS

## Original Government Survey

Year surveyed \_\_\_\_\_  
Original monument \_\_\_\_\_  
(Wood post, stone, pile of stones, pipe, etc.)

## Bearing Trees

Species \_\_\_\_\_  
Diameter \_\_\_\_\_  
Bearing \_\_\_\_\_  
Distance \_\_\_\_\_

## Subsequent Corner Restoration

Year surveyed \_\_\_\_\_ By \_\_\_\_\_  
Where filed or recorded \_\_\_\_\_  
Monument \_\_\_\_\_  
(Original, concrete post, iron rod, etc.)

## Bearing Trees, Reference Objects

Species \_\_\_\_\_  
Diameter \_\_\_\_\_  
Bearing \_\_\_\_\_  
Distance \_\_\_\_\_

## Original Evidence Found

Year of search \_\_\_\_\_ By \_\_\_\_\_  
Monument found \_\_\_\_\_

## Original Bearing Trees Found

Species \_\_\_\_\_  
Diameter \_\_\_\_\_  
Bearing \_\_\_\_\_  
Distance \_\_\_\_\_

## Evidence of Subsequent Corner Restoration Found

Year of search 6-25-68 By Morrison-Kirt  
leg on W. side - 6" Birch which  
is approx. corner. Blue line painted  
W + S to swamp edge. This approx  
corner established by compass & chaining  
from approx corner 1/4 mi. W. and by  
correlation with old painted line

Relation of Evidence to Record Features Along Section Lines

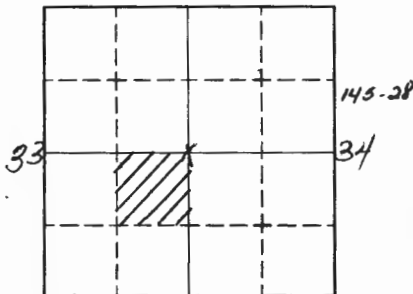

Sketch

○ Corner    ▨ F.S. Land

Section line to sections \_\_\_\_\_

Object \_\_\_\_\_

Record distance \_\_\_\_\_

Measured distance \_\_\_\_\_

Other Evidence

Describe evidence of use and occupation such as roads, fences, clearings, timber cutting lines, plantations, etc.. Cite source of testimony if any. \_\_\_\_\_

\_\_\_\_\_  
 \_\_\_\_\_  
 \_\_\_\_\_  
 \_\_\_\_\_  
 \_\_\_\_\_

Perpetuation Record

Monument and accessories established. Include brief description of area. \_\_\_\_\_

\_\_\_\_\_  
 \_\_\_\_\_  
 \_\_\_\_\_

See Restoration Certificate

At time of search:

1. Did you have the record description?

Yes \_\_\_\_\_ No

2. How was search area located?

~~Probing~~, chaining, photos, maps, etc. \_\_\_\_\_

3. Man hours spent in search \_\_\_\_\_

4. Do you think additional searching will recover evidence? Yes \_\_\_\_\_ No

5. Signature *J. M. Morrison*

**CERTIFICATE FILED**

Certified corner description on certificate prepared: \_\_\_\_\_

Yes \_\_\_\_\_

No \_\_\_\_\_

Filed in county records \_\_\_\_\_

*Case* Date *7/27/82* County Document No. *263906*

Identified on aerial photo No. \_\_\_\_\_

Which is filed at \_\_\_\_\_

Index No. X-17  
(Alphabetical - Numerical)

LAND CORNER RECORD  
(RECTANGULAR SURVEYS)

R9-7150-4 (Rev. 6/13/67)  
GPO 502-127

T. 145 N R. 28 W Mer. 5 N.F. Chip County Cass State MN  
74 Corner common to sections 34, 35 and \_\_\_\_\_

EXISTING SURVEYS

Original Government Survey

Year surveyed 1907  
Original monument wood post  
(Wood post, stone, pile of stones, etc.)

Bearing Trees

Species \_\_\_\_\_  
Diameter \_\_\_\_\_  
Bearing \_\_\_\_\_  
Distance \_\_\_\_\_

Subsequent Corner Restoration

Year surveyed \_\_\_\_\_ By \_\_\_\_\_  
Where filed or recorded \_\_\_\_\_  
Monument \_\_\_\_\_  
(Original, concrete post, iron rod, etc.)

Bearing Trees, Reference Objects

Species \_\_\_\_\_  
Diameter \_\_\_\_\_  
Bearing \_\_\_\_\_  
Distance \_\_\_\_\_

Original Evidence Found

Year of search \_\_\_\_\_ By \_\_\_\_\_  
Monument found \_\_\_\_\_

Original Bearing Trees Found

Species \_\_\_\_\_  
Diameter \_\_\_\_\_  
Bearing \_\_\_\_\_  
Distance \_\_\_\_\_

Evidence of Subsequent Corner Restoration Found

Year of search \_\_\_\_\_ By \_\_\_\_\_  
\_\_\_\_\_  
OVER  
\_\_\_\_\_

Bearing Trees, Reference Objects

Tam Bl Spruce W Pine  
7" 7" 9"  
S30E S70E N18E  
72.03' 63.03' 95.83'

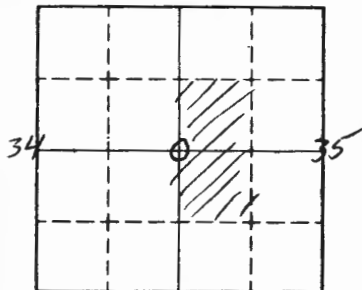

Sketch

○ Corner    ▨ F.S. Land

Relation of Evidence to Record Features Along Section Lines

Section line to sections \_\_\_\_\_  
 Object \_\_\_\_\_  
 Record distance \_\_\_\_\_  
 Measured distance \_\_\_\_\_

Other Evidence

Describe evidence of use and occupation such as roads, fences, clearings, timber cutting lines, plantations, etc.. Cite source of testimony if any. \_\_\_\_\_

At time of search:

1. Did you have the record description?

Yes \_\_\_\_\_ No \_\_\_\_\_

2. How was search area located?

Pacing, chaining, photos, maps, etc. \_\_\_\_\_

3. Man hours spent in search \_\_\_\_\_

4. Do you think additional search might recover evidence? Yes \_\_\_\_\_ No \_\_\_\_\_

5. Signature \_\_\_\_\_

Perpetuation Record

Monument and accessories established. Include brief description of area.

*I put up F.S.L.P. on the east side of a 6" Tag in an open swamp marking approx 1/4 cor. Old fence runs North of cor. I painted blue line North of cor.*

*9/76 13/Ron Olesen*

Certified for restoration certificate prepared: Yes \_\_\_\_\_ No \_\_\_\_\_

Filed in county records at Cass Date 9/22/82 County Document No. 263907

Identified on aerial photo No. \_\_\_\_\_

Which is filed at \_\_\_\_\_

**ORIGINAL FILED**

145 N R. 28 W<sup>+</sup> 5<sup>+</sup> R Mer. N.F. Chippewa County Cass State Minnesota  
Quarter Corner common to sections 31 and 36  
T145N R27W T145N R28W

EXISTING SURVEYS

Original Government Survey

Year surveyed \_\_\_\_\_  
Original monument See original notes  
(Wood post, stone, pile of stones, pipe, etc.)

Bearing Trees

Species \_\_\_\_\_  
Diameter \_\_\_\_\_  
Bearing \_\_\_\_\_  
Distance \_\_\_\_\_

Subsequent Corner Restoration

Year surveyed \_\_\_\_\_ By \_\_\_\_\_  
Where filed or recorded \_\_\_\_\_  
Monument \_\_\_\_\_  
(Original, concrete post, iron rod, etc.)

Bearing Trees, Reference Objects

Species \_\_\_\_\_  
Diameter \_\_\_\_\_  
Bearing \_\_\_\_\_  
Distance \_\_\_\_\_

Original Evidence Found

Year of search \_\_\_\_\_ By \_\_\_\_\_  
Monument found \_\_\_\_\_

Original Bearing Trees Found

Species \_\_\_\_\_  
Diameter \_\_\_\_\_  
Bearing \_\_\_\_\_  
Distance \_\_\_\_\_

Evidence of Subsequent Corner Restoration Found

Year of search \_\_\_\_\_ By \_\_\_\_\_  
\_\_\_\_\_  
\_\_\_\_\_  
\_\_\_\_\_

Bearing Trees, Reference Objects

\_\_\_\_\_  
\_\_\_\_\_  
\_\_\_\_\_  
\_\_\_\_\_

Relation of Evidence to Record Features Along Section Lines

Section line to sections \_\_\_\_\_  
 Object \_\_\_\_\_  
 Record distance \_\_\_\_\_  
 Measured distance \_\_\_\_\_

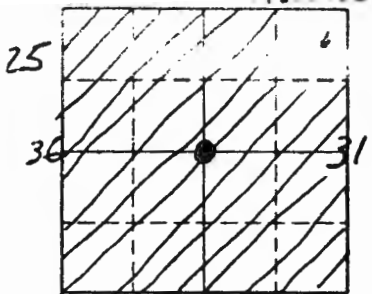

Sketch

○ Corner    ▨ F.S. Land

time of search: \_\_\_\_\_

Did you have the record description? \_\_\_\_\_

Yes \_\_\_\_\_ No

How was search area located? \_\_\_\_\_

By chaining, photos, map, \_\_\_\_\_

etc. \_\_\_\_\_

How many hours spent in search \_\_\_\_\_

Do you think additional search might recover evidence? Yes \_\_\_\_\_ No \_\_\_\_\_

Signature [Handwritten Signature]

Other Evidence

Describe evidence of use and occupation such as roads, fences, clearings, timber cutting lines, plantations, etc.. Cite source of testimony if any. \_\_\_\_\_

Perpetuation Record Whitchorn/Olesen

Monument and accessories established. Include brief description of area. 9-29-81  
Ind. 1912 John Curo (?) IP 30.5 meter South of pipeline  
and 18m west of forest trail

T145N R27W

BK 3, pp 7

<u>Red Pine</u>	<u>R. Pine Stump</u>	<u>R. Pine</u>
<u>36 cm</u>	<u>30 cm</u>	<u>36 cm</u>
<u>N38°E</u>	<u>S47°E</u>	<u>N87W</u>
<u>11.34m</u>	<u>16.02 m</u>	<u>9.13 meters</u>

Certified corner restoration certificate prepared: Yes \_\_\_\_\_ No

Filed in county records of \_\_\_\_\_ Date \_\_\_\_\_ County Document No. \_\_\_\_\_

Identified on aerial photo No. \_\_\_\_\_ Which is filed at \_\_\_\_\_



T. 145. R. 29=28 S. 5<sup>a</sup> Mer. N.F. Chippewa County Cass State Minnesota  
S<sup>11/16</sup> Corner common to sections 36, 31 and

EXISTING SURVEYS

Original Government Survey

Year surveyed \_\_\_\_\_

Original monument \_\_\_\_\_  
(Wood post, stone, pile of stones, pipe, etc.)

Bearing Trees

Species \_\_\_\_\_

Diameter \_\_\_\_\_

Bearing Needs Cut!

Distance \_\_\_\_\_

Original Evidence Found

Year of search \_\_\_\_\_ By \_\_\_\_\_

Monument found \_\_\_\_\_

Original Bearing Trees Found

Species \_\_\_\_\_

Diameter \_\_\_\_\_

Bearing \_\_\_\_\_

Distance \_\_\_\_\_

Subsequent Corner Restoration

Year surveyed \_\_\_\_\_ By \_\_\_\_\_

Where filed or recorded \_\_\_\_\_

Monument \_\_\_\_\_  
(Original, concrete post, iron rod, etc.)

Bearing Trees, Reference Objects

Species <u>Red pine</u>	<u>red pine</u>
Diameter <u>16"</u>	<u>20"</u>
Bearing _____	_____
Distance <u>20.3 ft.</u>	<u>6 ft. 71.</u>

Evidence of Subsequent Corner Restoration Found

Year of search 7-19-67 By Morrison

Tag on W side of 16" R. pine which is a B.T. No brass Cap in evidence. This corner lies just off the edge of plantation - a brass Cap should be set here if we have sufficient information.

S.O. Copy

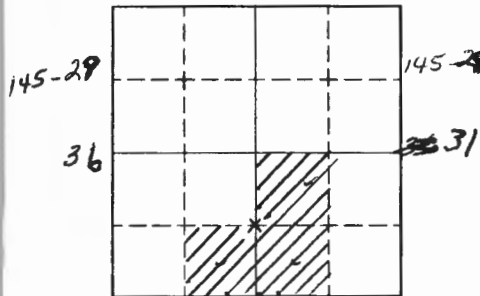

Sketch

○ Corner    ▨ F.S. Land

Relation of Evidence to Record Features Along Section Lines

Section line to sections \_\_\_\_\_

Object \_\_\_\_\_

Record distance \_\_\_\_\_

Measured distance \_\_\_\_\_

Other Evidence

Describe evidence of use and occupation such as roads, fences, clearings, timber cutting lines, plantations, etc.. Cite source of testimony if any. \_\_\_\_\_

\_\_\_\_\_

\_\_\_\_\_

\_\_\_\_\_

\_\_\_\_\_

At time of search:

1. Did you have the record description?

Yes \_\_\_\_\_ No

2. How was search area located?

Roading, chaining, photos, maps, etc. \_\_\_\_\_

\_\_\_\_\_

3. Man hours spent in search 1

4. Do you think additional search might recover evidence? Yes  No \_\_\_\_\_

\_\_\_\_\_

5. Signature *J. Morrison*

Perpetuation Record

Monument and accessories established. Include brief description of area. \_\_\_\_\_

\_\_\_\_\_

\_\_\_\_\_

\_\_\_\_\_

\_\_\_\_\_

Certified corner restoration certificate prepared: Yes \_\_\_\_\_ No \_\_\_\_\_

Filed in county records at \_\_\_\_\_ Date \_\_\_\_\_ County Document No. \_\_\_\_\_

Identified on aerial photo No. \_\_\_\_\_ Which is filed at \_\_\_\_\_

Index No. Y-14  
(Alphabetical - Numerical)LAND CORNER RECORD  
(RECTANGULAR SURVEYS)

RS-5680-11 (5/12/61)

T. 145 R. 28 5<sup>th</sup> Mer. N.F. Chippewa County Cass State Minnesota  
11/6 Corner common to sections 5W14-34 and \_\_\_\_\_

## EXISTING SURVEYS

## Original Government Survey

Year surveyed \_\_\_\_\_

Original monument \_\_\_\_\_  
(Wood post, stone, pile of stones, pipe, etc.)

## Bearing Trees

Species \_\_\_\_\_

Diameter \_\_\_\_\_

Bearing \_\_\_\_\_

Distance \_\_\_\_\_

## Original Evidence Found

Year of search \_\_\_\_\_

By \_\_\_\_\_

Monument found \_\_\_\_\_

## Original Bearing Trees Found

Species \_\_\_\_\_

Diameter \_\_\_\_\_

Bearing \_\_\_\_\_

Distance \_\_\_\_\_

## Subsequent Corner Restoration

Year surveyed \_\_\_\_\_ By \_\_\_\_\_

Where filed or recorded \_\_\_\_\_

Monument \_\_\_\_\_  
(Original, concrete post, iron rod, etc.)

## Bearing Trees, Reference Objects

Species \_\_\_\_\_

Diameter \_\_\_\_\_

Bearing \_\_\_\_\_

Distance \_\_\_\_\_

## Evidence of Subsequent Corner Restoration Found

Year of search 12-13-63 By S.M. Morrison  
Tag on S. side of 8" Tamarack. Blue  
line painted N-S-E of Corner No  
brass Cap on B.T.'s - old cut out line  
giving S. from this Corner.

Relation of Evidence to Record Features Along Section Lines

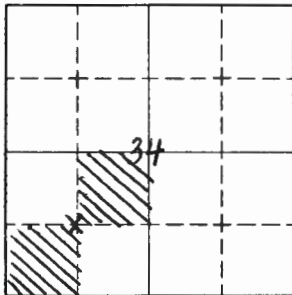

Sketch

○ Corner    ▨ F.S. Land

Section line to sections \_\_\_\_\_  
 Object \_\_\_\_\_  
 Record distance \_\_\_\_\_  
 Measured distance \_\_\_\_\_

Other Evidence

Describe evidence of use and occupation such as roads, fences, clearings, timber cutting lines, plantations, etc.. Cite source of testimony if any. \_\_\_\_\_  
 \_\_\_\_\_  
 \_\_\_\_\_  
 \_\_\_\_\_  
 \_\_\_\_\_

At time of search:

1. Did you have the record description?

Yes \_\_\_\_\_ No

2. How was search area located?

~~Racing~~, chaining, photos, maps, etc. \_\_\_\_\_  
 \_\_\_\_\_

3. Man hours spent in search 1

4. Do you think additional search might recover evidence? Yes \_\_\_\_\_ No

5. Signature J. M. Morrison

Perpetuation Record

Monument and accessories established. Include brief description of area. \_\_\_\_\_  
 \_\_\_\_\_  
 \_\_\_\_\_  
 \_\_\_\_\_  
 \_\_\_\_\_

Certified corner restoration certificate prepared: Yes \_\_\_\_\_ No \_\_\_\_\_

Filed in county records at \_\_\_\_\_ Date \_\_\_\_\_ County Document No. \_\_\_\_\_

Identified on aerial photo No. \_\_\_\_\_ Which is filed at \_\_\_\_\_

Index No. 7-16

(Alphabetical - Numerical)

LAND CORNER RECORD  
(RECTANGULAR SURVEYS)

RS-5680-11 (5/12/61)

T. 145 R. 28 5<sup>th</sup> Mer. N.F. Chippewa County Cass State Minnesota  
116 Corner common to sections SE 1/4 34 and \_\_\_\_\_

## EXISTING SURVEYS

## Original Government Survey

Year surveyed \_\_\_\_\_  
Original monument \_\_\_\_\_  
(Wood post, stone, pile of stones, pipe, etc.)

## Bearing Trees

Species \_\_\_\_\_  
Diameter \_\_\_\_\_  
Bearing \_\_\_\_\_  
Distance \_\_\_\_\_

## Subsequent Corner Restoration

Year surveyed \_\_\_\_\_ By \_\_\_\_\_  
Where filed or recorded \_\_\_\_\_  
Monument \_\_\_\_\_  
(Original, concrete post, iron rod, etc.)

## Bearing Trees, Reference Objects

Species \_\_\_\_\_  
Diameter \_\_\_\_\_  
Bearing \_\_\_\_\_  
Distance \_\_\_\_\_

## Original Evidence Found

Year of search \_\_\_\_\_ By \_\_\_\_\_  
Monument found \_\_\_\_\_

## Original Bearing Trees Found

Species \_\_\_\_\_  
Diameter \_\_\_\_\_  
Bearing \_\_\_\_\_  
Distance \_\_\_\_\_

## Evidence of Subsequent Corner Restoration Found

Year of search 12-18-63 By S. M. Morrison  
Tag on N. side 9.3" Willow. Blue line  
pointed W & N of Corner. No brass cap  
in B 75. This approximate corner was  
established by M. Lauritsen & Ross  
Sucker on 2-11-59. Re-Checked 12-18-63

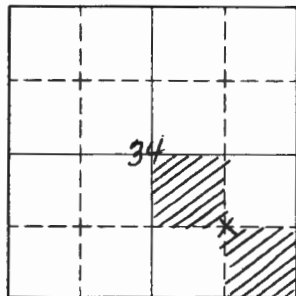

Sketch

○ Corner    ▨ F.S. Land

Relation of Evidence to Record Features Along Section Lines

Section line to sections \_\_\_\_\_  
 Object \_\_\_\_\_  
 Record distance \_\_\_\_\_  
 Measured distance \_\_\_\_\_

Other Evidence

Describe evidence of use and occupation such as roads, fences, clearings, timber cutting lines, plantations, etc.. Cite source of testimony if any. \_\_\_\_\_  
 \_\_\_\_\_  
 \_\_\_\_\_  
 \_\_\_\_\_

At time of search:

1. Did you have the record description?

Yes \_\_\_\_\_ No

2. How was search area located?

Probing, chaining, photos, maps, etc. \_\_\_\_\_  
 \_\_\_\_\_

3. Man hours spent in search 1

4. Do you think additional search might recover evidence? Yes \_\_\_\_\_ No

5. Signature J. M. Morrison

Perpetuation Record

Monument and accessories established. Include brief description of area. \_\_\_\_\_  
 \_\_\_\_\_  
 \_\_\_\_\_  
 \_\_\_\_\_

Certified corner restoration certificate prepared: Yes \_\_\_\_\_ No \_\_\_\_\_

Filed in county records at \_\_\_\_\_ Date \_\_\_\_\_ County Document No. \_\_\_\_\_

Identified on aerial photo No. \_\_\_\_\_ Which is filed at \_\_\_\_\_

Index No. Z-14  
(Alphabetical - Numerical)

LAND CORNER RECORD  
(RECTANGULAR SURVEYS)

RS-5680-11 (5/12/61)

T. 145 R. 28 5<sup>th</sup> Mer. N.F. Chippewa County Cass State Minnesota  
W 1/16 Corner common to sections 34 and \_\_\_\_\_

EXISTING SURVEYS

Original Government Survey

Year surveyed \_\_\_\_\_  
Original monument \_\_\_\_\_  
(Wood post, stone, pile of stones, pipe, etc.)

Bearing Trees

Species \_\_\_\_\_  
Diameter \_\_\_\_\_  
Bearing \_\_\_\_\_  
Distance \_\_\_\_\_

Original Evidence Found

Year of search \_\_\_\_\_ By \_\_\_\_\_  
Monument found \_\_\_\_\_

Original Bearing Trees Found

Species \_\_\_\_\_  
Diameter \_\_\_\_\_  
Bearing \_\_\_\_\_  
Distance \_\_\_\_\_

Subsequent Corner Restoration

Year surveyed \_\_\_\_\_ By \_\_\_\_\_  
Where filed or recorded \_\_\_\_\_  
Monument \_\_\_\_\_  
(Original, concrete post, iron rod, etc.)

Bearing Trees, Reference Objects

Species \_\_\_\_\_  
Diameter \_\_\_\_\_  
Bearing \_\_\_\_\_  
Distance \_\_\_\_\_

Evidence of Subsequent Corner Restoration Found

Year of search 12-13-63 By S. M. Morrison  
Tag on N. side of 3" Tamarack - Blue  
line pointed N & W of corner. Another  
tag is 5 chains West and is for the  
township South of this

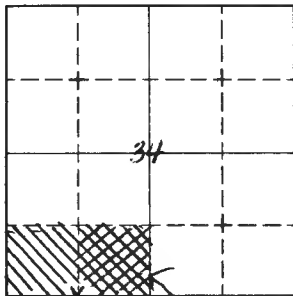

Sketch

○ Corner    ▨ F.S. Land

Relation of Evidence to Record Features Along Section Lines

Section line to sections \_\_\_\_\_

Object \_\_\_\_\_

Record distance \_\_\_\_\_

Measured distance \_\_\_\_\_

Other Evidence

Describe evidence of use and occupation such as roads, fences, clearings, timber cutting lines, plantations, etc.. Cite source of testimony if any. \_\_\_\_\_

\_\_\_\_\_

\_\_\_\_\_

\_\_\_\_\_

\_\_\_\_\_

\_\_\_\_\_

Perpetuation Record

Monument and accessories established. Include brief description of area. \_\_\_\_\_

\_\_\_\_\_

\_\_\_\_\_

\_\_\_\_\_

\_\_\_\_\_

\_\_\_\_\_

Certified corner restoration certificate prepared:      Yes \_\_\_\_\_ No \_\_\_\_\_

Filed in county records at \_\_\_\_\_ Date \_\_\_\_\_ County Document No. \_\_\_\_\_

Identified on aerial photo No. \_\_\_\_\_ Which is filed at \_\_\_\_\_

At time of search:

1. Did you have the record description?

Yes \_\_\_\_\_ No

2. How was search area located?

~~Pacing~~, chaining, photos, maps, etc. \_\_\_\_\_

3. Man hours spent in search 1

4. Do you think additional search might

recover evidence? Yes \_\_\_\_\_ No

5. Signature

*J.M. Morrison*



T. 145 R. 28 S. 5 Mer. N.F. Chippewa County Cass State MN  
S 1/4 Corner common to sections 34 and \_\_\_\_\_

EXISTING SURVEYS

Original Government Survey	Original Evidence Found
Year surveyed <u>1871</u>	Year of search _____ By _____
Original monument <u>wood post</u> <small>(Wood post, stone, pile of stones, pipe, etc.)</small>	Monument found _____
Bearing Trees	Original Bearing Trees Found
Species _____	Species _____
Diameter _____	Diameter _____
Bearing _____	Bearing _____
Distance _____	Distance _____
Subsequent Corner Restoration	Evidence of Subsequent Corner Restoration Found
Year surveyed <u>1907</u> By <u>John Curo</u>	Year of search <u>1982</u> By <u>Gary Stevenson</u>
Where filed or recorded _____	<u>Reset 2" x 60" galv iron Pipe with brass cap in place of post point. Post placed alongside.</u>
Monument <u>reset corner-tamarack post</u> <small>(Original, concrete post, iron rod, etc.)</small>	_____
Bearing Trees, Reference Objects	Bearing Trees, Reference Objects
Species _____	<u>Tamarack</u> <u>Tamarack</u> <u>Tamarack</u> <u>Tamarack</u>
Diameter _____	<u>5"</u> <u>5"</u> <u>4"</u> <u>4"</u>
Bearing _____	<u>N22W</u> <u>N70W</u> <u>N60E</u> <u>N20E</u>
Distance _____	<u>21.54'</u> <u>23.80'</u> <u>13.60'</u> <u>14.17'</u>

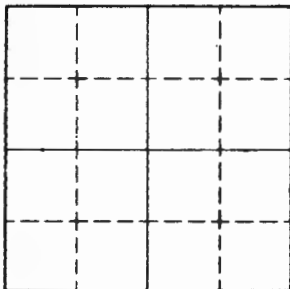

Sketch

○ Corner    ▨ F.S. Land

Relation of Evidence to Record Features Along Section Lines

Section line to sections \_\_\_\_\_  
Object \_\_\_\_\_  
Record distance \_\_\_\_\_  
Measured distance \_\_\_\_\_

Other Evidence

Describe evidence of use and occupation such as roads, fences, clearings, timber cutting lines, plantations, etc.. Cite source of testimony if any. \_\_\_\_\_  
\_\_\_\_\_  
\_\_\_\_\_  
\_\_\_\_\_  
\_\_\_\_\_

At time of search:

1. Did you have the record description?

Yes \_\_\_\_\_ No \_\_\_\_\_

2. How was search area located?

Pacing, chaining, photos, maps, etc. \_\_\_\_\_  
\_\_\_\_\_  
\_\_\_\_\_

3. Man hours spent in search \_\_\_\_\_

4. Do you think additional search might recover evidence? Yes \_\_\_\_\_ No \_\_\_\_\_

5. Signature \_\_\_\_\_

Perpetuation Record

Monument and accessories established. Include brief description of area. \_\_\_\_\_  
\_\_\_\_\_  
\_\_\_\_\_  
\_\_\_\_\_

**CERTIFICATE FILED**

Certified corner restoration certificate prepared: \_\_\_\_\_

Yes \_\_\_\_\_ No \_\_\_\_\_

Filed in county records at Cass Date 7/22/82 County Document No. 263909

Identified on aerial photo No. \_\_\_\_\_ Which is filed at \_\_\_\_\_

Index No. Z-15  
(Alphabetical - Numerical)

BK # 1  
 Pg. 44

LAND CORNER RECORD  
(RECTANGULAR SURVEYS)

RD-7150-4 (Rev. 6/13/67)  
 GPO 502-127

T. 145 R. 28 Mer. N.F. CHIPPEWA County CASS State MD  
SOUTH QUARTER Corner common to sections \_\_\_\_\_ and 34

EXISTING SURVEYS

Original Government Survey

Year surveyed 1873 By P. H. CONGER  
 Original monument WOOD POST  
(Wood post, stone, pile of stones, pipe, etc.)

Bearing Trees

Species NO BT'S  
 Diameter \_\_\_\_\_  
 Bearing \_\_\_\_\_  
 Distance \_\_\_\_\_

Subsequent Corner Restoration

Year surveyed 1907 By CASS COUNTY SURVEYOR  
 Where filed or recorded J. W. CURO BK B SURV. # 304  
 Monument SET NEW 4" TAM. POST 5' LONG  
(Original, concrete post, iron rod, etc.)

MARKED NEW BT'S.

Bearing Trees, Reference Objects

Species	<u>TAM.</u>	<u>DEAD TAM.</u>
Diameter	<u>4</u>	<u>3</u>
Bearing	<u>N28E</u>	<u>N58W</u>
Distance	<u>53.0'</u>	<u>53.50'</u>

Original Evidence Found

Year of search \_\_\_\_\_ By \_\_\_\_\_  
 Monument found \_\_\_\_\_

Original Bearing Trees Found

Species \_\_\_\_\_  
 Diameter \_\_\_\_\_  
 Bearing \_\_\_\_\_  
 Distance \_\_\_\_\_

Evidence of Subsequent Corner Restoration Found

Year of search 5-7-82 By GK GB  
FD. CURO'S. TAM POST - IN PLACE.  
CHAINED FROM SW COR SEC 34  
2644' COUNTY DISTANCE.

Bearing Trees, Reference Objects

\_\_\_\_\_  
 \_\_\_\_\_  
 \_\_\_\_\_  
 \_\_\_\_\_

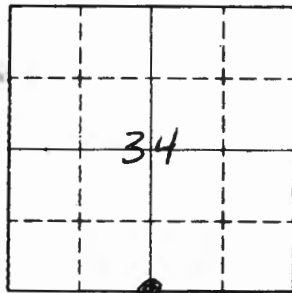

Sketch

○ Corner    ▣ F.S. Land

Relation of Evidence to Record Features Along Section Lines

Section line to sections \_\_\_\_\_  
 Object \_\_\_\_\_  
 Record distance \_\_\_\_\_  
 Measured distance \_\_\_\_\_

Other Evidence

Describe evidence of use and occupation such as roads, fences, clearings, timber cutting lines, plantations, etc.. Cite source of testimony if any. 5/7/82

Placed a F.S.L.P. on 4" TAM, N73E at 2.0'  
 Placed a 8" steel sign post 5.0' west of iron.

At time of search:

1. Did you have the record description?

Yes  No \_\_\_\_\_

2. How was search area located?

Pacing chaining, photos, maps, etc.

3. Man hours spent in search 3 HRS.

4. Do you think additional search might recover evidence? Yes \_\_\_\_\_ No \_\_\_\_\_

5. Signature Curt Krause

Perpetuation Record

Monument and accessories established. Include brief description of area. 5/7/82

SET 2" DIA. X 5' LONG IRON PIPE WITH CAP MKD T145N R28W  
 Mtd New BT'S Scribed SC

1. TAM, 5", N70W at 23.80'	1/4 534 SCBT	1/4 • 534
2. TAM, 5", N22W at 21.54'	1/4 534 SCBT	1982
3. TAM, 4", N20E at 14.17'	1/4 534 SCBT	RLS NO 12684
4 TAM, 4", N60E at 13.60'	1/4 534 SCBT	

Wired a 8" steel sign post to galv. p. pipe. Both B.C. & sign post set 1.0' above water line John Curo's wood post is on south side of Iron. (wired on)

Certified corner restoration certificate prepared: Yes \_\_\_\_\_ No \_\_\_\_\_

Filed in county records at \_\_\_\_\_ Date \_\_\_\_\_ County Document No. \_\_\_\_\_

Identified on aerial photo No. \_\_\_\_\_ Which is filed at \_\_\_\_\_

Index No. Z-17 BK#1  
(Alphabetical - Numerical) Pg. 43

LAND CORNER RECORD  
(RECTANGULAR SURVEYS)

RS-7 150-4 (Rev. 6/13/67)  
 GPO 502-127

T. 145 R. 28 S. Mer. N.F. CHIPPEWA County CASS State MN  
 STD. SECTION COR. Corner common to sections 34 and 35

EXISTING SURVEYS

Original Government Survey

Year surveyed 1871 P. H. CONGER  
 Original monument WOOD POST  
(Wood post, stone, pile of stones, pipe, etc.)

Bearing Trees

Species	<u>ASH</u>	<u>ASH</u>
Diameter	<u>9</u>	<u>6</u>
Bearing	<u>N22E</u>	<u>N59W</u>
Distance	<u>28 LKS.</u> <u>18.5'</u>	<u>15 LKS.</u> <u>9.9'</u>

Subsequent Corner Restoration

Year surveyed 1907 By CASS COUNTY SURVEYOR  
 Where filed or recorded J. W. CURD BKB SURV. #304  
 Monument SET NEW WOOD POST  
(Original, concrete post, iron rod, etc.)

FOUND BOTH ORIG. BT'S.

Bearing Trees, Reference Objects

Species	<u>ASH</u>	<u>ASH</u>
Diameter	<u>9</u>	<u>6</u>
Bearing	<u>N28°27E</u>	<u>N58-44W</u>
Distance	<u>18.5</u>	<u>9.90</u>

Original Evidence Found

Year of search \_\_\_\_\_ By \_\_\_\_\_  
 Monument found \_\_\_\_\_

Original Bearing Trees Found

Species	_____	_____
Diameter	_____	_____
Bearing	_____	_____
Distance	_____	_____

Evidence of Subsequent Corner Restoration Found

Year of search 5-7-82 By CK-6B  
FD. PARTLY FLAT POST (ASH) LYING ON GRD.  
FD. POINT OF OLD POST IN PLACE  
FD. EVIDENCE OF ROTTED ASH STUMPS (DRIG.)

Bearing Trees, Reference Objects

Species	_____	_____
Diameter	_____	_____
Bearing	_____	_____
Distance	_____	_____

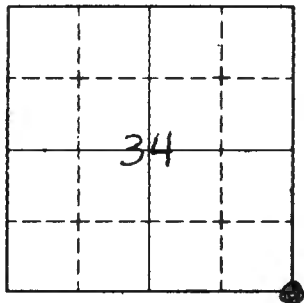

Sketch

○ Corner  F.S. Land

Relation of Evidence to Record Features Along Section Lines

Section line to sections \_\_\_\_\_  
 Object \_\_\_\_\_  
 Record distance \_\_\_\_\_  
 Measured distance \_\_\_\_\_

Other Evidence

Describe evidence of use and occupation such as roads, fences, clearings, timber cutting lines, plantations, etc.. Cite source of testimony if any. \_\_\_\_\_

At time of search:

1. Did you have the record description?

Yes  No \_\_\_\_\_

2. How was search area located?

Pacing, chaining, photos, maps,  
 etc. \_\_\_\_\_

3. Man hours spent in search 3 HRS.

4. Do you think additional search might recover evidence? Yes \_\_\_\_\_ No \_\_\_\_\_

5. Signature Curt Krause

Perpetuation Record

Monument and accessories established. Include brief description of area. \_\_\_\_\_

SET 2" DIA X 5' LONG IRON PIPE WITH CAP MKD T145NR28W  
SC

<u>N. PINE 17 N63E 98.35</u>	<u>T145NR28W535</u>	<u>SC BT</u>	<u>S34</u>	<u>S35</u>
<u>ASPEN 8 N7E 65.35</u>	<u>S35</u>	<u>SC BT</u>	<u>T144N</u>	
<u>ASPEN 7 N48W 42.15</u>	<u>S34</u>	<u>SC BT</u>	<u>1982</u>	
<u>N. PINE 23 N89W 150.30</u>	<u>T145NR28W5346</u>	<u>SC BT</u>	<u>RLS</u>	<u>NO 12684</u>

Certified corner restoration certificate prepared: Yes \_\_\_\_\_ No \_\_\_\_\_  
 Filed in county records at \_\_\_\_\_ Date \_\_\_\_\_ County Document No. \_\_\_\_\_  
 Identified on aerial photo No. \_\_\_\_\_ Which is filed at \_\_\_\_\_

Index No. Z-17  
(Alphabetical - Numerical)

LAND CORNER RECORD  
(RECTANGULAR SURVEYS)

R9-7150-4 (Rev. 6/13/67)  
 GPO 802-127

T. 145 R. 28 SE Mer. N.F. Shippewa County Cross State Mn  
 Corner common to sections 34 and \_\_\_\_\_

EXISTING SURVEYS

Original Government Survey

Year surveyed 1871 GLO  
 Original monument Wood post  
(Wood post, stone, pile of stones, pipe, etc.)

Bearing Trees

Species	<u>Ash</u>	<u>Ash</u>
Diameter	<u>9"</u>	<u>6"</u>
Bearing	<u>N22E</u>	<u>N59W</u>
Distance	<u>28 lks.</u>	<u>15 lks.</u>

Original Evidence Found

Year of search \_\_\_\_\_ By \_\_\_\_\_  
 Monument found \_\_\_\_\_

Original Bearing Trees Found

Species	_____	_____	_____
Diameter	_____	_____	_____
Bearing	_____	_____	_____
Distance	_____	_____	_____

Subsequent Corner Restoration

Year surveyed 1907 By John Cross  
 Where filed or recorded \_\_\_\_\_  
 Monument \_\_\_\_\_  
(Original, concrete post, iron rod, etc.)

Evidence of Subsequent Corner Restoration Found

Year of search 1982 By Gary Stevenson  
set 2" x 60" galv iron pipe with brass  
caps in place of all post point.

Bearing Trees, Reference Objects

Species	_____	_____	_____
Diameter	_____	_____	_____
Bearing	_____	_____	_____
Distance	_____	_____	_____

Bearing Trees, Reference Objects

Species	<u>Aspen</u>	<u>Aspen</u>	<u>N Pine</u>
Diameter	<u>7"</u>	<u>8"</u>	<u>17"</u>
Bearing	<u>N48W</u>	<u>N7E</u>	<u>N63E</u>
Distance	<u>42.15'</u>	<u>65.35'</u>	<u>98.35'</u>

Sign Posts 5' N and 5' E

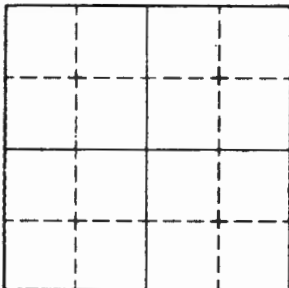

Sketch

Corner  F.S. Land

Relation of Evidence to Record Features Along Section Lines

Section line to sections \_\_\_\_\_

Object \_\_\_\_\_

Record distance \_\_\_\_\_

Measured distance \_\_\_\_\_

Other Evidence

Describe evidence of use and occupation such as roads, fences, clearings, timber cutting lines, plantations, etc.. Cite source of testimony if any. \_\_\_\_\_

At time of search:

1. Did you have the record description?

Yes \_\_\_\_\_ No \_\_\_\_\_

2. How was search area located?

Pacing, chaining, photos, maps, etc. \_\_\_\_\_

3. Man hours spent in search \_\_\_\_\_

4. Do you think additional search might recover evidence? Yes \_\_\_\_\_ No \_\_\_\_\_

Perpetuation Record

Monument and accessories established. Include brief description of area. \_\_\_\_\_

# CERTIFICATE FILED

Certified corner restoration certificate prepared: *a* Yes *Gary Stevenson* No

Filed in county records at *Case* Date *7/22/82* County Document No. *263900*

Identified on aerial photo No. \_\_\_\_\_ Which is filed at \_\_\_\_\_

5. Signature \_\_\_\_\_





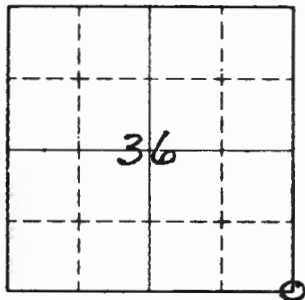

Sketch

○ Corner    ▨ F.S. Land

Relation of Evidence to Record Features Along Section Lines

Section line to sections \_\_\_\_\_  
 Object \_\_\_\_\_  
 Record distance \_\_\_\_\_  
 Measured distance \_\_\_\_\_

Other Evidence

Describe evidence of use and occupation such as roads, fences, clearings, timber cutting lines, plantations, etc.. Cite source of testimony if any. \_\_\_\_\_

At time of search:

1. Did you have the record description?

Yes \_\_\_\_\_ No \_\_\_\_\_

2. How was search area located?

Pacing, chaining, photos, maps,  
 etc. \_\_\_\_\_

3. Man hours spent in search \_\_\_\_\_

4. Do you think additional search might

recover evidence? Yes \_\_\_\_\_ No \_\_\_\_\_

5. Signature \_\_\_\_\_

Perpetuation Record

Monument and accessories established. Include brief description of area. \_\_\_\_\_

Certified corner restoration certificate prepared: Yes \_\_\_\_\_ No \_\_\_\_\_

Filed in county records at \_\_\_\_\_ Date \_\_\_\_\_ County Document No. \_\_\_\_\_

Identified on aerial photo No. \_\_\_\_\_ Which is filed at \_\_\_\_\_