

LEGEND

○ = Corner having information on form 7100-52 in this file.

T147N R25W 5th P.M.

FILING INSTRUCTION

(Ref. FSM 7150)

File 7100-52 card record by letter and number coordinates behind the file guide for the township in which it falls.

File the 7100-52 card record by letter and then by number i.e., all A cards first, then B cards etc.

The first card behind the file guide (if data have been obtained and recorded) will be card A-1 for N.W. Township Corner, then card A-2 for 1/16 corner then card A-3 for 1/4 corner etc.

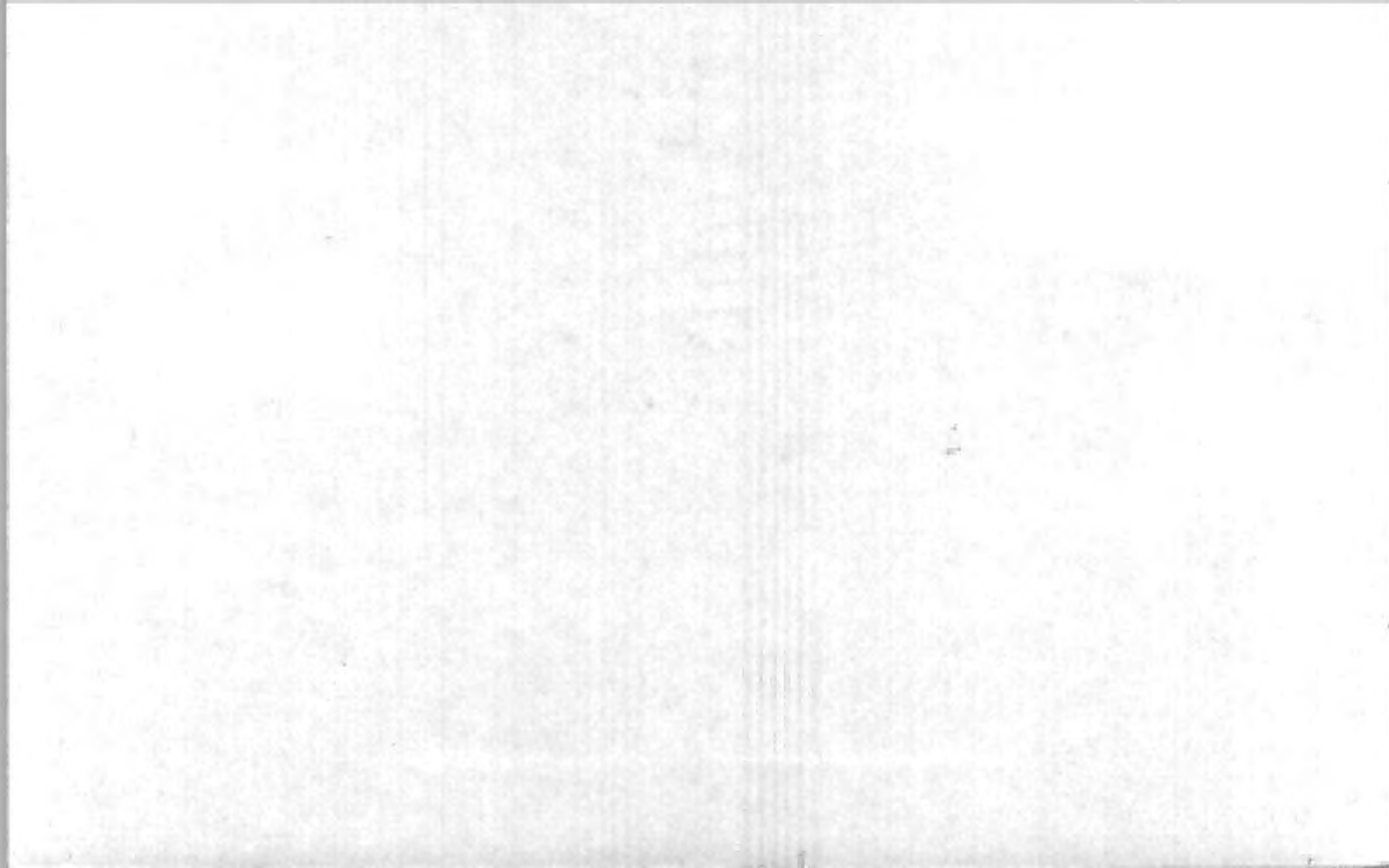

147 R. 25 Mer. 5th N.F. CHIPPewa County ITASCA State MN
SEC Corner common to sections 1 2 35 and 36

EXISTING SURVEYS

Original Government Survey	Original Evidence Found
Year surveyed _____	Year of search _____ By _____
Original monument _____ <small>(wood post, stone, pile of stones, pipe, etc.)</small>	Monument found _____
Bearing Trees	Original Bearing Trees Found
Species _____	Species _____
Diameter _____	Diameter _____
Bearing _____	Bearing _____
Distance _____	Distance _____
Subsequent Corner Restoration	Evidence of Subsequent Corner Restoration Found
Year surveyed _____ By _____	Year of search _____ By _____
Where filed or recorded _____	_____
Monument _____ <small>(original, concrete post, iron rod, etc.)</small>	_____
<u>SEE BOOK 2 Pg 66</u>	_____
Bearing Trees, Reference Objects	Bearing Trees, Reference Objects
Species _____	_____
Diameter _____	_____
Bearing _____	_____
Distance _____	_____

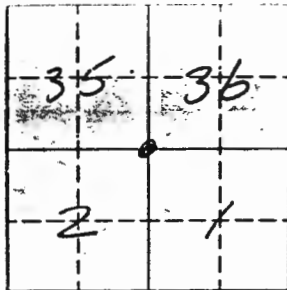

Sketch

O Corner F.S. Land

Section line to sections _____
 Object _____
 Record distance _____
 Measured distance _____

Other Evidence

Describe evidence of use and occupation such as roads, fences, clearings, timber cutting lines, plantations, etc.. Cite source of testimony if any. _____

At time of search:

1. Did you have the record description?
 Yes _____ No _____

2. How was search area located?
 Pacing, chaining, photos, maps,
 etc. _____

3. Man hours spent in search _____

4. Do you think additional search might
 recover evidence? Yes _____ No _____

5. Signature B. Ausk

Perpetuation Record

Monument and accessories established. Include brief description of area. _____

Set a 2" by 24" IRON PIPE w/a 3" BRASS CAP
STAMPED

From which:

Ask 8" N54°W 84.38'
Balsam 7" N62 1/2°E 80.67'
MAPLE 4 1/2" S14°E 76.12'
Balsam 10" S30°W 89.39'
4x4 CEDAR Post S43°W 43.40' W/54-6

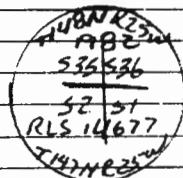

K. Whitehorn

Certified corner restoration certificate prepared: Yes _____ No _____
 Filed in county records at _____ Date _____ County Document No. _____
 Identified on aerial photo No. _____ Which is filed at _____

147 25 5th Mer. N.F. CHIFFEWA County ITASCA State MINN
1/4 Corner common to sections 36 1 and

EXISTING SURVEYS

Original Government Survey	Original Evidence Found
Year surveyed _____ Original monument _____ <small>(Wood post, stone, pile of stones, pipe, etc.)</small>	Year of search _____ By _____ Monument found _____
Bearing Trees Species _____ Diameter _____ Bearing _____ Distance _____	Original Bearing Trees Found Species _____ Diameter _____ Bearing _____ Distance _____
Subsequent Corner Restoration Year surveyed _____ By _____ Where filed or recorded _____ Monument _____ <small>(Original, concrete post, iron rod, etc.)</small> <u>SEE BOOK 2 PAGE 46</u>	Evidence of Subsequent Corner Restoration Found Year of search _____ By _____ _____ _____ _____
Bearing Trees, Reference Objects Species _____ Diameter _____ Bearing _____ Distance _____	Bearing Trees, Reference Objects _____ _____ _____ _____

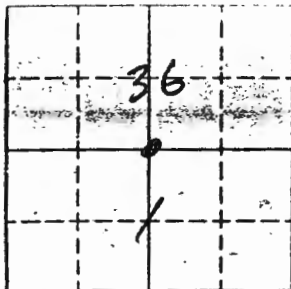

Sketch

Corner F.S. Land

At time of search:

1. Did you have the record description?

Yes _____ No _____

2. How was search area located?

Pacing, chaining, photos, maps,
etc. _____

3. Man hours spent in search _____

4. Do you think additional search might
recover evidence? Yes _____ No _____

5. Signature

B. AUST

Section line to sections _____

Object: _____

Record distance: _____

Measured distance _____

Other Evidence

Describe evidence of use and occupation such as roads, fences, clearings, timber cutting lines, plantations, etc.. Cite source of testimony if any. _____

Perpetuation Record

Monument and accessories established. Include brief description of area. _____

*12-8-92 Kn Whitehorn RECOVERED COUNTY
MONUMENT AND TWO Bts*

Certified corner restoration certificate prepared: _____

Yes _____ No _____

Filed in county records at _____

Date _____

County Document No. _____

Identified on aerial photo No. _____

Which is filed at _____

Index No. A-24
(Alphabetical - Numerical)

LAND CORNER RECORD
(RECTANGULAR SURVEYS)

RD-7150-4 (Rev. 6/13/67)
 GPO 502-127

T. 147N R. 25W 5th P. Mer. N.F. Chippewa County Itasca State Minnesota
East 1/4 Corner common to sections on north line of Section 1

EXISTING SURVEYS									
<p style="text-align: center;">Original Government Survey</p> <p>Year surveyed <u>Dec 1875, B.C. Baldwin</u></p> <p>Original monument <u>none set</u> <small>(Wood post, stone, pile of stones, pipe, etc.)</small></p> <p style="text-align: center;">Bearing Trees</p> <p>Species _____</p> <p>Diameter _____</p> <p>Bearing _____</p> <p>Distance _____</p>	<p style="text-align: center;">Original Evidence Found</p> <p>Year of search _____ By _____</p> <p>Monument found _____</p> <p style="text-align: center;">Original Bearing Trees Found</p> <p>Species _____</p> <p>Diameter _____</p> <p>Bearing _____</p> <p>Distance _____</p>								
<p style="text-align: center;">Subsequent Corner Restoration <u>Established</u></p> <p>Year surveyed <u>Dec 7, 1982</u> By <u>H.S.F.S. K. Whitehorn, RLS</u></p> <p>Where filed or recorded <u>Itasca County Recorder's Office</u></p> <p>Monument <u>7/8 in x 1/2 inch alum rod w/ 3/4 in Alum Cap</u> <small>(Original, concrete post, iron rod, etc.)</small> <u>below water level in beaver plunge;</u> <u>See BK 2, pp 55</u> Corner Stamped:</p> <p><u>Red line east and south</u></p> <p>Decl: <u>15° East</u> Bearing Trees, Reference Objects</p> <table style="width:100%; border: none;"> <tr> <td style="width:50%;">Species <u>Ash</u></td> <td style="width:50%;">Species <u>Ash</u></td> </tr> <tr> <td>Diameter <u>11.5 in</u></td> <td>Diameter <u>5.8 in</u></td> </tr> <tr> <td>Bearing <u>N 11° W</u></td> <td>Bearing <u>N 89° E</u></td> </tr> <tr> <td>Distance <u>61.50 ft</u></td> <td>Distance <u>69.10 ft</u></td> </tr> </table>	Species <u>Ash</u>	Species <u>Ash</u>	Diameter <u>11.5 in</u>	Diameter <u>5.8 in</u>	Bearing <u>N 11° W</u>	Bearing <u>N 89° E</u>	Distance <u>61.50 ft</u>	Distance <u>69.10 ft</u>	<p style="text-align: center;">Evidence of Subsequent Corner Restoration Found</p> <p>Year of search _____ By _____</p> <p style="text-align: center;">Bearing Trees, Reference Objects</p> <p>Species _____</p> <p>Diameter _____</p> <p>Bearing _____</p> <p>Distance _____</p>
Species <u>Ash</u>	Species <u>Ash</u>								
Diameter <u>11.5 in</u>	Diameter <u>5.8 in</u>								
Bearing <u>N 11° W</u>	Bearing <u>N 89° E</u>								
Distance <u>61.50 ft</u>	Distance <u>69.10 ft</u>								

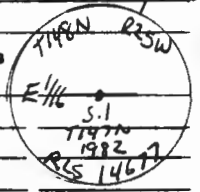

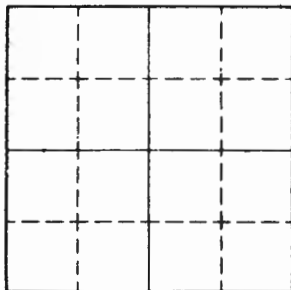

Sketch

○ Corner ▨ F.S. Land

Relation of Evidence to Record Features Along Section Lines

Section line to sections _____
 Object _____
 Record distance _____
 Measured distance _____

Other Evidence

Describe evidence of use and occupation such as roads, fences, clearings, timber cutting lines, plantations, etc.. Cite source of testimony if any. _____

At time of search:

1. Did you have the record description?
 Yes _____ No _____

2. How was search area located?
 Pacing, chaining, photos, maps,
 etc. _____

3. Man hours spent in search _____

4. Do you think additional search might
 recover evidence? Yes _____ No _____

5. Signature _____

Perpetuation Record

Monument and accessories established. Include brief description of area. _____

Certified corner restoration certificate prepared: Yes _____ No _____

Filed in county records at _____ Date _____ County Document No. _____

Identified an aerial photo No. _____ Which is filed at _____

Index No. B-21
(Alphabetical - Numerical)

LAND CORNER RECORD
(RECTANGULAR SURVEYS)

R9-7150-4 (Rev. 6/13/67)
 GPO 802-127

T. 147 N R. 25 W 5th Mer. N.F. Chippewa County Itasca State Minnesota
North 1/4 Corner common to sections 1 & 2 and _____

EXISTING SURVEYS

Original Government Survey

Year surveyed _____
 Original monument _____
(Wood post, stone, pile of stones, pipe, etc.)

Bearing Trees

Species _____
 Diameter _____
 Bearing _____
 Distance _____

Subsequent Corner Restoration

Year surveyed 1920 By Itasca CO. P.C. Warner
 Where filed or recorded _____
 Monument Iron
(Original, concrete post, iron rod, etc.)

Bearing Trees, Reference Objects

Species Pine St.
 Diameter 40"
 Bearing S88E
 Distance 11.5'

Original Evidence Found

Year of search _____ By _____
 Monument found _____

Original Bearing Trees Found

Species _____
 Diameter _____
 Bearing _____
 Distance _____

Evidence of Subsequent Corner Restoration Found

Year of search 1981 By R. Olson
found Tree in place

Bearing Trees, Reference Objects

Pine St.
40"
580 1/2 E
11.5'
w/scribe

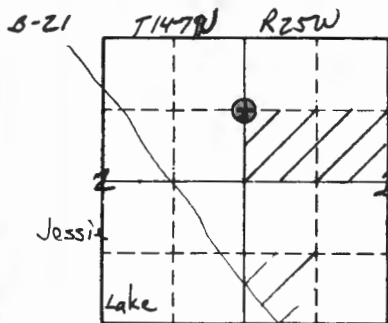

Sketch

○ Corner ▨ F.S. Land

Relation of Evidence to Record Features Along Section Lines

Section line to sections _____
 Object _____
 Record distance _____
 Measured distance _____

Other Evidence

Describe evidence of use and occupation such as roads, fences, clearings, timber cutting lines, plantations, etc.. Cite source of testimony if any. _____

At time of search:

1. Did you have the record description?

Yes _____ No _____

2. How was search area located?

Pacing, chaining, photos, maps,
 etc. _____

3. Man hours spent in search _____

4. Do you think additional search might
 recover evidence? Yes _____ No _____

5. Signature *[Handwritten Signature]*

Perpetuation Record

Monument and accessories established. Include brief description of area. *BK 2, pp 53*

Dec 6, 1982 - set 2 in X 60 in gold IP with 3 in brass tablet up 1.5 ft and stamped:

Red line east and south. Bent over 1920 co. IP bears West 1.65 ft

Decl: 5° East

<i>Ash</i>	<i>Ash</i>	<i>Ash</i>
<i>6.4 in</i>	<i>4.8 in</i>	<i>5.0 in</i>
<i>S 20° E</i>	<i>S 74° W</i>	<i>N 31° W</i>
<i>36.10 A</i>	<i>39.40 A</i>	<i>82.70 ft</i>

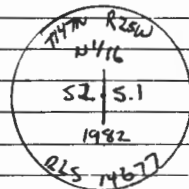

Certified corner restoration certificate prepared: Yes _____ No *NO*

Filed in county records at _____ Date _____ County Document No. _____

Identified on aerial photo No. _____ Which is filed at _____

Index No. B-22
(Alphabetical - Memorized)

LAND CORNER RECORD
(RECTANGULAR SURVEYS)

RD-7150-4 (Rev. 6/13/67)
 GPO 802-127

T. 147N R. 25W 5th Mer. N.F. Chippewa County Itasca State Minnesota
North West 1/4 Corner common to sections 1 and _____

EXISTING SURVEYS

Original Government Survey

Year surveyed _____
 Original monument _____
(Wood post, stone, pile of stones, pipe, etc.)

Bearing Trees

Species _____
 Diameter _____
 Bearing _____
 Distance _____

Subsequent Corner Restoration

Year surveyed 1920 By Itasca Co. R.L. Warner
 Where filed or recorded _____
 Monument Iron
(Original, concrete post, iron rod, etc.)

Bearing Trees, Reference Objects

Species J. Pine L. Pine _____
 Diameter 5" 5" _____
 Bearing S89W S40W _____
 Distance 65.3 85.4 _____

Original Evidence Found

Year of search _____ By _____
 Monument found _____

Original Bearing Trees Found

Species _____
 Diameter _____
 Bearing _____
 Distance _____

Evidence of Subsequent Corner Restoration Found

Year of search 1981 By R. Oleson
None

falls in center of road

Bearing Trees, Reference Objects

J. Pine J. Pine _____
65.3 85.4 _____
w/scrub w/scrub

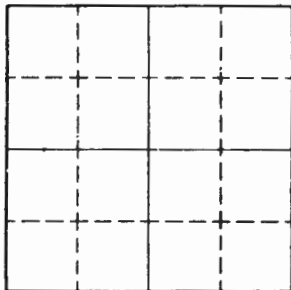

Sketch

Corner F.S. Land

Relation of Evidence to Record Features Along Section Lines

Section line to sections _____

Object _____

Record distance _____

Measured distance _____

Other Evidence

Describe evidence of use and occupation such as roads, fences, clearings, timber cutting lines, plantations, etc.. Cite source of testimony if any. _____

At time of search:

1. Did you have the record description?

Yes _____ No _____

2. How was search area located?

Pacing, chaining, photos, maps, etc. _____

3. Man hours spent in search _____

4. Do you think additional search might recover evidence? Yes _____ No _____

5. Signature _____

Perpetuation Record

Monument and accessories established. Include brief description of area. _____

*BK 2, pp 14 set nail from BT's and used as traverse pt # 63
no monument set ~~Kentville~~ MS*

Certified corner restoration certificate prepared: Yes _____ No NO

Filed in county records at _____ Date _____ County Document No. _____

Identified on aerial photo No. _____ Which is filed at _____

Index No. B-23
(Alphabetical - Memorized)LAND CORNER RECORD
(RECTANGULAR SURVEYS)

RD-7150-4 (Rev. 6/13/67)

GPO 802-127

T. 147 N R. 25 W 5th Mer. N.F. Chippewa County Itasca State Minnesota
Center North 1/10 Corner common to sections 1 and _____

EXISTING SURVEYS

Original Government Survey

Year surveyed _____

Original monument _____
(Wood post, stone, pile of stones, pipe, etc.)

Bearing Trees

Species _____

Diameter _____

Bearing _____

Distance _____

Original Evidence Found

Year of search _____ By _____

Monument found _____

Original Bearing Trees Found

Species _____

Diameter _____

Bearing _____

Distance _____

Subsequent Corner Restoration

Year surveyed 1920 By Itasca Co. P. Warner

Where filed or recorded _____

Monument Iron
(Original, concrete post, iron rod, etc.)

Evidence of Subsequent Corner Restoration Found

Year of search 1981 By Ron Olasonfound Iron at record dist.

Bearing Trees, Reference Objects

Species Birch Birch _____Diameter 8" 9" _____Bearing S79E S44W _____Distance 37.9' 29.1' _____

Bearing Trees, Reference Objects

No Bts found _____1' North _____

B-23 Sec 9, Twp 147N Rge 25W

Jessie

Lake

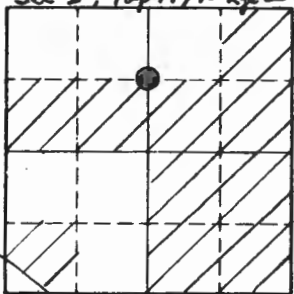

Sketch

○ Corner ▨ F.S. Land

Relation of Evidence to Record Features Along Section Lines

Section line to sections _____

Object _____

Record distance _____

Measured distance _____

Other Evidence

Describe evidence of use and occupation such as roads, fences, clearings, timber cutting lines, plantations, etc.. Cite source of testimony if any. _____

At time of search:

1. Did you have the record description?
Yes _____ No _____

2. How was search area located?
Pacing, chaining, photos, maps, etc. _____

3. Man hours spent in search _____

4. Do you think additional search might recover evidence? Yes _____ No _____

5. Signature [Signature] ELS

Perpetuation Record

Monument and accessories established. Include brief description of area. BK 2, pp 52

Dec 7, 1982 - set on 2 in x 3 1/2 in galv IP with 3 in brass tablet up 0.7 ft and stamped:
Red line east and west

Decl: 5° East

<u>Ash</u>	<u>Ash</u>	<u>Ash</u>
<u>7.4 in</u>	<u>7.1 in</u>	<u>5.6 in</u>
<u>N22°E</u>	<u>S57°E</u>	<u>S38°W</u>
<u>50.60 ft</u>	<u>73.20</u>	<u>79.00 ft</u>

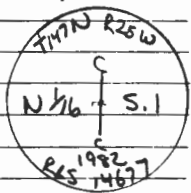

Certified corner restoration certificate prepared: Yes _____ No NO

Filed in county records at _____ Date _____ County Document No. _____

Identified on aerial photo No. _____ Which is filed at _____

Index No. B-24
(Alphabetical - Numerical)

LAND CORNER RECORD
(RECTANGULAR SURVEYS)

R9-7150-4 (Rev. 6/13/67)
 GPO 502-127

T. 147 N R. 254 5th Mer. N.F. Chippewa County Itasca State Minnesota
NE 1/4 Corner common to sections _____ and _____

EXISTING SURVEYS

Original Government Survey	Original Evidence Found
Year surveyed _____	Year of search _____ By _____
Original monument _____ <small>(Wood post, stone, pile of stones, pipe, etc.)</small>	Monument found _____
Bearing Trees	Original Bearing Trees Found
Species _____	Species _____
Diameter _____	Diameter _____
Bearing _____	Bearing _____
Distance _____	Distance _____
Subsequent Corner Restoration	Evidence of Subsequent Corner Restoration Found
Year surveyed <u>1920</u> By <u>Itasca Co. Rd. Warner</u>	Year of search <u>1981</u> By <u>R. Oleson</u>
Where filed or recorded _____	<u>found Iron in place</u>
Monument <u>Iron</u> <small>(Original, concrete post, iron rod, etc.)</small>	
	<u>2-22-83 BA 16R</u>
Bearing Trees, Reference Objects	Bearing Trees, Reference Objects
Species <u>Birch</u> <u>Balsam</u>	<u>Mon to 1920 Iron</u> <u>N25°E</u>
Diameter <u>6"</u> <u>5"</u>	
Bearing <u>N89E</u> <u>N26W</u>	<u>9"</u>
Distance <u>32.2'</u> <u>13.5'</u>	<u>13.5'</u> <u>w/scribe</u>

B-24 Section 2, T147N R25W

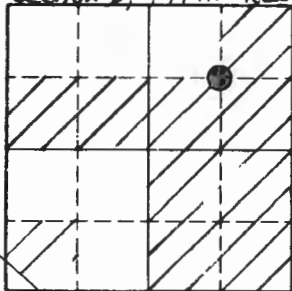

Jessie
Lake

Sketch

○ Corner ▨ F.S. Land

Relation of Evidence to Record Features Along Section Lines

Section line to sections _____
 Object _____
 Record distance _____
 Measured distance _____

Other Evidence

Describe evidence of use and occupation such as roads, fences, clearings, timber cutting lines, plantations, etc.. Cite source of testimony if any. _____

At time of search:

1. Did you have the record description?

Yes _____ No _____

2. How was search area located?

Pacing, chaining, photos, maps, etc. _____

3. Man hours spent in search _____

4. Do you think additional search might recover evidence? Yes _____ No _____

5. Signature [Signature] RLS

Perpetuation Record

Monument and accessories established. Include brief description of area. BK 2, PP 54
 On Dec 7, 1982 set a Zinox 36 in galv IP with 3 in brass tablet, up 0.7 ft and stamped:
 Red line north and west

Decl: 5° East

W. Spruce	Balsam Fir	Cedar
8.2 in	5.8 in	15.8 in
N74°E	S14°W	N34°W
27.30 ft	27.30 ft	93.30 ft

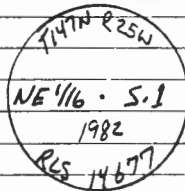

Certified corner restoration certificate prepared: Yes _____ No No

Filed in county records at _____ Date _____ County Document No. _____

Identified on aerial photo No. _____ Which is filed at _____

Index No. C-1
(Alphabetical - Numerical)

LAND CORNER RECORD
(RECTANGULAR SURVEYS)

RS-5680-11 (5/12/64)

T. 147 R. 25-26W 5th Mer. N.F. Chippewa County Itasca State Minnesota
Corner common to sections 1 and 6

EXISTING SURVEYS

Original Government Survey	Original Evidence Found
Year surveyed _____	Year of search _____ By _____
Original monument _____ <small>(Wood post, stone, pile of stones, pipe, etc.)</small>	Monument found _____
Bearing Trees	Original Bearing Trees Found
Species _____	Species _____
Diameter _____	Diameter _____
Bearing _____	Bearing _____
Distance _____	Distance _____
Subsequent Corner Restoration	Evidence of Subsequent Corner Restoration Found
Year surveyed _____ By _____	Year of search _____ By _____
Where filed or recorded _____	_____
Monument _____ <small>(Original, concrete post, iron rod, etc.)</small>	_____
_____	_____
_____	_____
Bearing Trees, Reference Objects	
Species _____	
Diameter _____	
Bearing _____	
Distance _____	

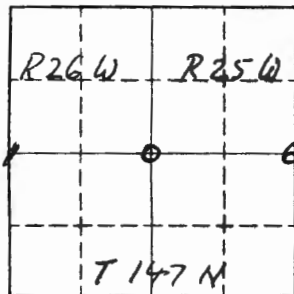

Sketch

○ Corner F.S. Land

Relation of Evidence to Record Features Along Section Lines

Section line to sections _____
 Object _____
 Record distance _____
 Measured distance _____

Other Evidence

Describe evidence of use and occupation such as roads, fences, clearings, timber cutting lines, plantations, etc.. Cite source of testimony if any. _____

See affidavits

At time of search:

1. Did you have the record description?

Yes _____ No _____

2. How was search area located?

Pacing, chaining, photos, maps, etc. _____

3. Man hours spent in search _____

4. Do you think additional search might recover evidence? Yes _____ No _____

5. Signature _____

Perpetuation Record

Monument and accessories established. Include brief description of area. _____

Set a 2" inside dia. 5' long gal. wrought iron pipe filled w/concrete and capped with a 3" dia. bronze tablet stamped

Elm	Basswood	Elm	T147N R25-26W
5"	6"	4"	1/4 Corner Sec. 1-6
N23°W	S 64°W	N40°E	1958
21.0'	11.3'	10.3'	RLS No. 3628

Certified corner restoration certificate prepared: Yes No _____

Filed in county records at Itasca Date 1958 County Document No. _____

Identified on aerial photo No. _____ Which is filed at _____

Index No. C-21
(Alphabetical - Numerical)

LAND CORNER RECORD
(RECTANGULAR SURVEYS)

RD-7150-4 (Rev. 6/13/67)
 GPO 802-127

T. 147N R. 25W 5th Mer. N.F. Chippewa County Itasca State Minnesota
79 Corner common to sections 1 & 2

EXISTING SURVEYS

Original Government Survey

Year surveyed _____
 Original monument _____
(Wood post, stone, pile of stones, pipe, etc.)

Bearing Trees

Species Cedar Cedar _____
 Diameter 12" 8" _____
 Bearing S66W N10E _____
 Distance 10 lks 8 lks. _____

Subsequent Corner Restoration

Year surveyed 1920 By Itasca Co. P.C. Warner
 Where filed or recorded _____
 Monument Iron
(Original, concrete post, iron rod, etc.)

Bearing Trees, Reference Objects

Species Tam Dnd Spruce _____
 Diameter 7" 8" _____
 Bearing N25E S36W _____
 Distance 6.8' 17.8' _____

Original Evidence Found

Year of search _____ By _____
 Monument found _____

Original Bearing Trees Found

Species _____
 Diameter _____
 Bearing _____
 Distance _____

Evidence of Subsequent Corner Restoration Found

Year of search 1981 By R. Oleson
found
Iron in place

Bearing Trees, Reference Objects

Tam Stump
6.8'

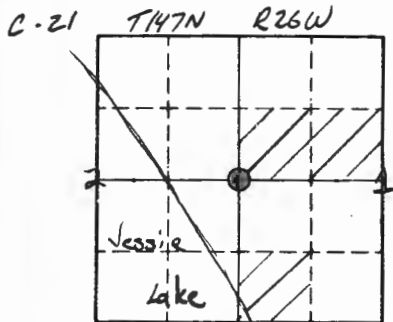

Sketch

○ Corner ▨ F.S. Land

Relation of Evidence to Record Features Along Section Lines

Section line to sections _____
 Object _____
 Record distance _____
 Measured distance _____

Other Evidence

Describe evidence of use and occupation such as roads, fences, clearings, timber cutting lines, plantations, etc.. Cite source of testimony if any. _____

At time of search:

1. Did you have the record description?

Yes _____ No _____

2. How was search area located?

Pacing, chaining, photos, maps, etc. _____

3. Man hours spent in search _____

4. Do you think additional search might recover evidence? Yes _____ No _____

5. Signature *[Handwritten Signature]*

Perpetuation Record

Monument and accessories established. Include brief description of area. *BK 2, pp 47*
Aug 24, 1982 - set 2" x 60" in galv IP with 3" brass tablet stamped:
Red line south and east

Ash	Ash	Ash
7.0 in	7.2 in	7.2 in
N44°W	N21½°E	S12½°E
24.90 ft	27.10 ft	15.70 ft

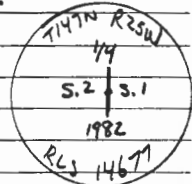

Certified corner restoration certificate prepared: Yes No _____

Filed in county records at _____ Date _____ County Document No. *356851*

Identified on aerial photo No. _____ Which is filed at _____

Index No. C-22
(Alphabetical - Numerical)

LAND CORNER RECORD
(RECTANGULAR SURVEYS)

RD-7150-4 (Rev. 6/13/67)
GPO 802-127

T. 147 N R. 25 W Mer. N.F. Chippewa County Itasca State Minnesota
Center West 1/6 Corner common to sections 1 and _____

EXISTING SURVEYS

Original Government Survey

Year surveyed _____
Original monument _____
(Wood post, stone, pile of stones, pipe, etc.)

Bearing Trees

Species _____
Diameter _____
Bearing _____
Distance _____

Subsequent Corner Restoration

Year surveyed 1920 By Itasca Co. P.C. Warner
Where filed or recorded _____
Monument Iron
(Original, concrete post, iron rod, etc.)

Bearing Trees, Reference Objects

Species J. Pine
Diameter 3"
Bearing 54°N
Distance 58.2'

Original Evidence Found

Year of search _____ By _____
Monument found _____

Original Bearing Trees Found

Species _____
Diameter _____
Bearing _____
Distance _____

Evidence of Subsequent Corner Restoration Found

Year of search 1981 By R. Olson
found None

Iron on Edge of road by State of Minn
Not in position

Bearing Trees, Reference Objects

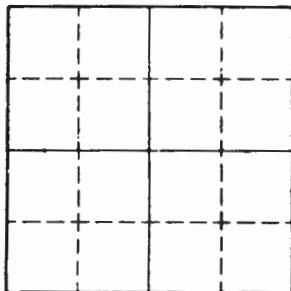

Sketch

Corner F.S. Land

Relation of Evidence to Record Features Along Section Lines

Section line to sections _____
Object _____
Record distance _____
Measured distance _____

Other Evidence

Describe evidence of use and occupation such as roads, fences, clearings, timber cutting lines, plantations, etc.. Cite source of testimony if any. _____

At time of search:

1. Did you have the record description?

Yes _____ No _____

2. How was search area located?

Pacing, chaining, photos, maps,
etc. _____

3. Man hours spent in search _____

4. Do you think additional search might

recover evidence? Yes _____ No _____

5. Signature _____

Perpetuation Record

Monument and accessories established. Include brief description of area. _____

Certified corner restoration certificate prepared: Yes _____ No _____

Filed in county records at _____ Date _____ County Document No. _____

Identified on aerial photo No. _____ Which is filed at _____

Index No. C-23
(Alphabetical - Numerical)

LAND CORNER RECORD
(RECTANGULAR SURVEYS)

RD-7150-4 (Rev. 6/15/67)
 GPO 802-127

T. 147N R. 25W 5th Mer. N.F. Chippewa County Itasca State Minnesota
Center 1/4 Corner common to sections 1 and _____

EXISTING SURVEYS

Original Government Survey

Year surveyed _____
 Original monument _____
(Wood post, stone, pile of stones, pipe, etc.)

Bearing Trees

Species _____
 Diameter _____
 Bearing _____
 Distance _____

Subsequent Corner Restoration

Year surveyed 1920 By Itasca Co. P.C. Warner
 Where filed or recorded _____
 Monument Iron
(Original, concrete post, iron rod, etc.)

Bearing Trees, Reference Objects

Species Spruce Ash _____
 Diameter 11" 8" _____
 Bearing N75E S41W _____
 Distance 23.7' 15.4' _____

Original Evidence Found

Year of search _____ By _____
 Monument found _____

Original Bearing Trees Found

Species _____
 Diameter _____
 Bearing _____
 Distance _____

Evidence of Subsequent Corner Restoration Found

Year of search 1981 By R. Oleson

Iron not in place
2 12 02 R.D. T.P.
M.D.

Bearing Trees, Reference Objects

Spruce st. Ash _____
 _____ 55°W _____
23.7' 15.4' 16.0'
w/scribe

C-23 T147N R25W Section 1

Relation of Evidence to Record Features Along Section Lines

basie Lake

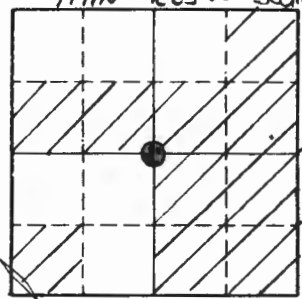

Sketch

○ Corner ▨ F.S. Land

Section line to sections _____

Object _____

Record distance _____

Measured distance _____

Other Evidence

Describe evidence of use and occupation such as roads, fences, clearings, timber cutting lines, plantations, etc.. Cite source of testimony if any. _____

At time of search:

1. Did you have the record description?

Yes _____ No _____

2. How was search area located?

Pacing, chaining, photos, maps, etc. _____

3. Man hours spent in search _____

4. Do you think additional search might recover evidence? Yes _____ No _____

5. Signature *[Handwritten Signature]* RLS

Perpetuation Record

Monument and accessories established. Include brief description of area. BK2, P 68

Dec 7, 1982 set a 2 in x 60 inch gale IP with brass tablet up 1.5 ft and stamped: Red line South and west.

Decl: 5° East

<u>Black Ash</u>	<u>Black Ash</u>	<u>Black Ash</u>
<u>12.2 in</u>	<u>6.5 in</u>	<u>17.5 in</u>
<u>N68°E</u>	<u>S08°W</u>	<u>N66°W</u>
<u>51.10 ft</u>	<u>42.90 ft</u>	<u>61.40 ft</u>

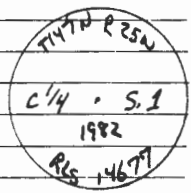

Certified corner restoration certificate prepared: Yes _____ No No

Filed in county records at _____ Date _____ County Document No. _____

Identified on aerial photo No. _____ Which is filed at _____

Index No. C-25
(Alphabetical - Numerical)

LAND CORNER RECORD
(RECTANGULAR SURVEYS)

RD-7150-4 (Rev. 6/13/67)
 GPO 802-127

T. 147N R. 25W 5th P. Mer. N.F. Chippewa County Itasca State Minnesota
Standard East Quarter Corner common to sections 2 and _____

EXISTING SURVEYS

Original Government Survey

Year surveyed May 31, 1867 George E. Stuntz
 Original monument post
(Wood post, stone, pile of stones, pipe, etc.)

Bearing Trees

Species	<u>B. Pine</u>	<u>B. Pine</u>
Diameter	<u>8 in</u>	<u>7 in</u>
Bearing	<u>N 45° W</u>	<u>S 16° W</u>
Distance	<u>12 1/2</u>	<u>10 1/2</u>
	<u>792 ft</u>	<u>660 ft</u>

Original Evidence Found

Year of search _____ By _____
 Monument found _____

Original Bearing Trees Found

Species	_____
Diameter	_____
Bearing	_____
Distance	_____

Subsequent Corner Restoration

Year surveyed unknown By Itasca Co. Rd Engineer
 Where filed or recorded _____
 Monument _____
(Original, concrete post, iron rod, etc.)

Evidence of Subsequent Corner Restoration Found

Year of search Sept 1920 By L.W. Johnson, Itasca Co. Surv.
 Field notes state "... to 1/4 cor of Sec. 1 on Range line found
 2 BT's set by Road Engineer ... The 1/4 cor of 1 is alright
 and would probably find gov't BT's but old piles are
 burned at this point."

Bearing Trees, Reference Objects

Species	<u>unk</u>	<u>unk</u>
Diameter	_____	_____
Bearing	_____	_____
Distance	_____	_____

Bearing Trees, Reference Objects

Pine Stp	Pine Stp	J. Pine
<u>14 in</u>	<u>10 in</u>	<u>6 in</u>
<u>S 32° W</u>	<u>N 60° W</u>	<u>S 52° W</u>
<u>70.8 ft</u>	<u>64.5 ft</u>	<u>76.0 ft</u>

C-25

T147N

R25W

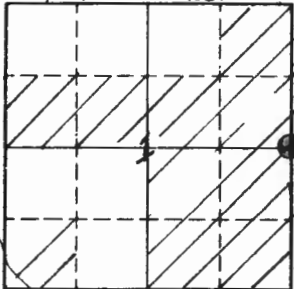

Meridian

3rd Guide

Jessie Lake

Sketch

○ Corner ▨ F.S. Land

Relation of Evidence to Record Features Along Section Lines

Section line to sections _____

Object _____

Record distance _____

Measured distance _____

Other Evidence

Describe evidence of use and occupation such as roads, fences, clearings, timber cutting lines, plantations, etc.. Cite source of testimony if any. _____

MN/DOT Hwy plans indicate this corner to be a "Marked post" in place 1932 Survey, also indicate 1 in IP 65.5' E of new E alignment ~~at~~ unk.

Circa 1965 - Itasca County surveyor - found old location tags on side of road but ignored and prolated N&S between Twp Cor & Cor Sec 13/24 (reset using land calls) and E #6 for E-W control. Set 1/4 in IP W. Pine, 8 in, S84°W, 63.08 ft. J. Pine, 5 in, N57°W, 62.02 ft

At time of search:

1. Did you have the record description?
Yes _____ No _____

2. How was search area located?
Pacing, chaining, photos, maps, etc. _____

3. Man hours spent in search _____

4. Do you think additional search might recover evidence? Yes _____ No _____

5. Signature *[Signature]* 1-19-83

Perpetuation Record

Monument and accessories established. Include brief description of area.
*Nov 18, 1982 - find iron pipe and set rebar even for traverse pt.
See Book 2, pp 44 147N R25W*

<i>J. Pine</i>	<i>J. Pine</i>
<i>11.0 inch</i>	<i>8.3 inch</i>
<i>N88°W</i>	<i>N49 1/2°W</i>
<i>63.05 ft</i>	<i>62.27 ft</i>

Certified corner restoration certificate prepared: Yes ⁶ _____ No _____

Filed in county records at _____ Date _____ County Document No. _____

Identified on aerial photo No. _____ Which is filed at _____

Index No. D-21
(Alphabetical - Numerical)

LAND CORNER RECORD
(RECTANGULAR SURVEYS)

RG-7 150-4 (Rev. 6/15/67)
 GPO 802-127

T. 147 N. R. 25 W. Mer. N.F. _____ County _____ State _____
5 1/16 Corner common to sections 1 2 and _____

EXISTING SURVEYS

Original Government Survey

Year surveyed _____

Original monument _____
(Wood post, stone, pile of stones, pipe, etc.)

Bearing Trees

Species _____

Diameter _____

Bearing _____

Distance _____

Original Evidence Found

Year of search _____ By _____

Monument found _____

Original Bearing Trees Found

Species _____

Diameter _____

Bearing _____

Distance _____

Subsequent Corner Restoration

Year surveyed. 1920 By Itasca Co. Bd. Warren

Where filed or recorded _____

Monument Iron
(Original, concrete post, iron rod, etc.)

Evidence of Subsequent Corner Restoration Found

Year of search 1981 By R. Olesen

found Iron

Tag by State of Minn. By Iron

Bearing Trees, Reference Objects

Species Bal N. Rail Track

Diameter 5" 56 E.

Bearing S39 E 98.6'

Distance 34.8'

Bearing Trees, Reference Objects

No Bts BEARING TO IRON

5.75'

0-21

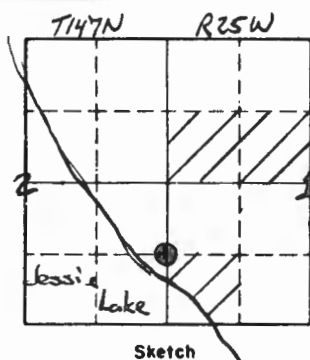

Relation of Evidence to Record Features Along Section Lines

Section line to sections _____

Object _____

Record distance _____

Measured distance _____

Other Evidence

Describe evidence of use and occupation such as roads, fences, clearings, timber cutting lines, plantations, etc.. Cite source of testimony if any. _____

At time of search:

1. Did you have the record description?

Yes _____ No _____

2. How was search area located?

Pacing, chaining, photos, maps,
etc. _____

3. Man hours spent in search _____

4. Do you think additional search might
recover evidence? Yes _____ No _____5. Signature *[Signature]* RLS

Perpetuation Record

Monument and accessories established. Include brief description of area. *BK 2, P 74*
On Dec 3, 1982, set a 2 inch x 60 inch galv. IP with a 3 in brass tablet up 1.4 ft
and stamped in County pipe
Red line south and east

<i>Balsam</i>	<i>Cedar Stub</i>	<i>Spruce</i>	<i>Cedar</i>
<i>8.1 in</i>	<i>6.7 in</i>	<i>12.5 in</i>	<i>8.6 in</i>
<i>562°E</i>	<i>502°E</i>	<i>N49°N</i>	<i>505°E</i>
<i>28.90 ft</i>	<i>67.80 ft</i>	<i>35.27 ft</i>	<i>100.62 ft</i>

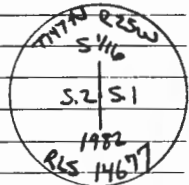
Decl: *5° East*Certified corner restoration certificate prepared: Yes _____ No *146*

Filed in county records at _____ Date _____ County Document No. _____

Identified on aerial photo No. _____ Which is filed at _____

Index No. D-23
(Alphabetical - Numerical)

LAND CORNER RECORD
(RECTANGULAR SURVEYS)

R9-7150-4 (Rev. 6/15/67)
GPO 802-127

T. 147 N R. 25 W 5th Mer. N.F. Chippewa County Itasca State Minnesota
Center South 1/16 Corner common to sections 1 and _____

EXISTING SURVEYS

Original Government Survey

Year surveyed _____
Original monument _____
(Wood post, stone, pile of stones, pipe, etc.)

Bearing Trees

Species _____
Diameter _____
Bearing _____
Distance _____

Subsequent Corner Restoration

Year surveyed 1920 By Itasca Co. P.C. Warner
Where filed or recorded _____
Monument Iron
(Original, concrete post, iron rod, etc.)

Bearing Trees, Reference Objects

Species Tan St. Poplar _____
Diameter 3" 4" _____
Bearing N10 W N84 E _____
Distance 74.6' 78.4' _____

Original Evidence Found

Year of search _____ By _____
Monument found _____

Original Bearing Trees Found

Species _____
Diameter _____
Bearing _____
Distance _____

Evidence of Subsequent Corner Restoration Found

Year of search 1981 By R. Oleson
Found
None

Bearing Trees, Reference Objects

found None _____

D-23

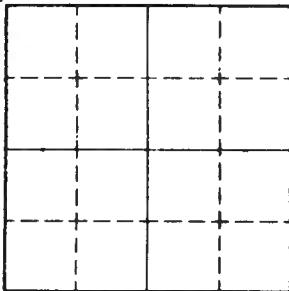

Sketch

○ Corner F.S. Land

Relation of Evidence to Record Features Along Section Lines

Section line to sections _____

Object _____

Record distance _____

Measured distance _____

Other Evidence

Describe evidence of use and occupation such as roads, fences, clearings, timber cutting lines, plantations, etc.. Cite source of testimony if any. _____

At time of search:

1. Did you have the record description?

Yes _____ No _____

2. How was search area located?

Pacing, chaining, photos, maps, etc. _____

3. Man hours spent in search _____

4. Do you think additional search might

recover evidence? Yes _____ No _____

5. Signature _____

Perpetuation Record

Monument and accessories established. Include brief description of area. _____

Certified corner restoration certificate prepared: Yes _____ No NO

Filed in county records at _____ Date _____ County Document No. _____

Identified on aerial photo No. _____ Which is filed at _____

Index No. DE-21
(Alphabetical - Numerical)

LAND CORNER RECORD
(RECTANGULAR SURVEYS)

RD-7150-4 (Rev. 6/13/67)
 GPO 802-127

T. 147N R. 25W
MC #2

5TB

Mer. N.F. Chippewa County Itasca

State Minnesota

Corner common to sections 1 and 2

EXISTING SURVEYS

Original Government Survey

Year surveyed _____
 Original monument _____
(Wood post, stone, pile of stones, pipe, etc.)

Bearing Trees

Species _____
 Diameter _____
 Bearing _____
 Distance _____

Subsequent Corner Restoration

Year surveyed _____ By _____
 Where filed or recorded _____
 Monument _____
(Original, concrete post, iron rod, etc.)

Bearing Trees, Reference Objects

Species _____
 Diameter _____
 Bearing _____
 Distance _____

Original Evidence Found

Year of search _____ By _____
 Monument found _____

Original Bearing Trees Found

Species _____
 Diameter _____
 Bearing _____
 Distance _____

Evidence of Subsequent Corner Restoration Found

Year of search _____ By _____
 See: BK 1 pg 50, 77
 See: BK 2 pg 42, 45

Bearing Trees, Reference Objects

Species _____
 Diameter _____
 Bearing _____
 Distance _____

DE21

T147N R25W

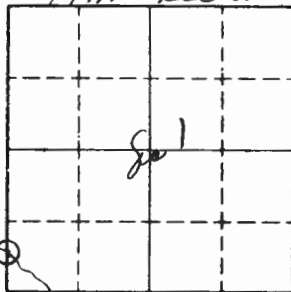

Sketch

○ Corner ▣ F.S. Land

Relation of Evidence to Record Features Along Section Lines

Section line to sections _____
 Object _____
 Record distance _____
 Measured distance _____

Other Evidence

Describe evidence of use and occupation such as roads, fences, clearings, timber cutting lines, plantations, etc.. Cite source of testimony if any. April 28 1983

The corner WCMC set in 1982 was destroyed by ice
 Reset a 5/8" diameter by 5 ft long aluminum
 rod w/a 3 1/4 in diameter aluminum cap stamp:

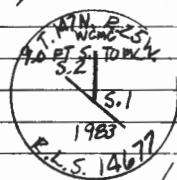

Same ties as in A82

At time of search:

1. Did you have the record description?

Yes No _____

2. How was search area located?

Pacing, chaining, photos, maps,

etc. maps3. Man hours spent in search 1/44. Do you think additional search might recover evidence? Yes _____ No 5. Signature Alan P. Kozenko

Perpetuation Record

Monument and accessories established. Include brief description of area. 1983

9.00 feet south of the WCMC I set a 5/8 in diameter
by 5 ft long aluminum rod with a 3 1/4 in. diameter aluminum cap

Ash	Cedar	Cedar	Same ties as
7.0 in	11.5 in	16.5 in	to the WCMC
N29°E	N73°E	N04°E	
44.92 ft	58.86 ft	114.03 ft	

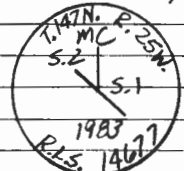

Certified corner restoration certificate prepared: Yes _____ No _____

Filed in county records at _____ Date _____ County Document No. _____

Identified on aerial photo No. _____ Which is filed at _____

Index No. DE-2112
(Alphabetical - Numerical)

LAND CORNER RECORD
(RECTANGULAR SURVEYS)

R9-7150-4 (Rev. 6/13/67)
 GPO 802-127

T. 147 N. R. 25 W. S. 5th P. Mer. N.F. Chippewa County Itasca State Minnesota
Meander Corner #3 Corner common to sections 1 and 2

EXISTING SURVEYS

Original Government Survey

Year surveyed December 1875, B.C. Baldwin
 Original monument Post
(Wood post, stone, pile of stones, pipe, etc.)

Bearing Trees

Species	<u>Birch</u>	<u>Ash</u>
Diameter	<u>7"</u>	<u>5"</u>
Bearing	<u>N 36° W</u>	<u>N 78° E</u>
Distance	<u>11 lks</u>	<u>11 lks</u>
	<u>7.26'</u>	<u>7.26'</u>

Subsequent Corner Restoration

Year surveyed Sept 1920 By L.W. Johnson
 Where filed or recorded Itasca County Courthouse, survey. 15
 Monument Set post 9' north of MC #2 Office
(Original, concrete post, iron rod, etc.)

Bearing Trees, Reference Objects

Species	
Diameter	
Bearing	
Distance	

Original Evidence Found

Year of search Oct 1920 By P.C. Warner
 Monument found None

Original Bearing Trees Found

Species	<u>Ash (standing)</u>
Diameter	
Bearing	
Distance	

Evidence of Subsequent Corner Restoration Found

Year of search _____ By _____
See BK 2, PP 45
Also Corner Card DE-21WC

Bearing Trees, Reference Objects

Species	
Diameter	
Bearing	
Distance	

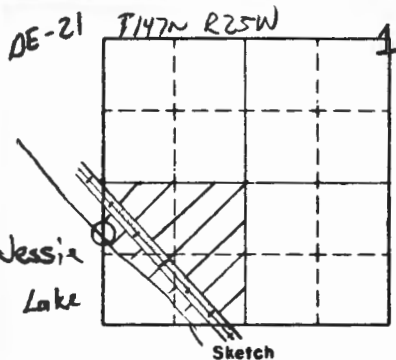

Relation of Evidence to Record Features Along Section Lines

Section line to sections _____

Object _____

Record distance _____

Measured distance _____

Other Evidence

Describe evidence of use and occupation such as roads, fences, clearings, timber cutting lines, plantations, etc.. Cite source of testimony if any. _____

At time of search:

1. Did you have the record description?

Yes _____ No _____

2. How was search area located?

Pacing, chaining, photos, maps,
etc. _____

3. Man hours spent in search _____

4. Do you think additional search might
recover evidence? Yes _____ No _____

1-18-83

5. Signature *[Handwritten Signature]*

Perpetuation Record

Monument and accessories established. Include brief description of area. *BK 2, PP 45*

Corner now falls 9.00 feet into the lake

Certified corner restoration certificate prepared: Yes No _____

Filed in county records at _____ Date _____ County Document No. _____

Identified on aerial photo No. _____ Which is filed at _____

T. 147N R. 25W 5th P. Mer. N.F. Chippewa County Itasca State Minnesota
North RR R-0-W property Corner common to sections 1 and 2

EXISTING SURVEYS

Original Government Survey

Year surveyed
 Original monument
(Wood post, stone, pile of stones, pipe, etc.)

Bearing Trees

Species
 Diameter
 Bearing
 Distance

Original Evidence Found

Year of search By
 Monument found

Original Bearing Trees Found

Species
 Diameter
 Bearing
 Distance

Subsequent Corner ~~Restoration~~ Establishment

Year surveyed Dec 9, 1982 By Ken Whitcomb R.L.S.
 Where filed or recorded Itasca County Recorder's Office
 Monument 2 in x 3/8 in galvanized iron pipe with 3 in diam
brass tablet flush with the ground and stamped:
(Original, concrete spot, iron, lead, etc.)

See BK 1, PP 74

Decl: 5° East Bearing Trees, Reference Objects

Species	<u>Elm</u>	<u>Elm</u>
Diameter	<u>7.9 in</u>	<u>4.6 in</u>
Bearing	<u>S14°W</u>	<u>N87°W</u>
Distance	<u>46.00 ft</u>	<u>37.00 ft</u>

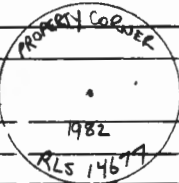

Evidence of Subsequent Corner Restoration Found

Year of search By

Bearing Trees, Reference Objects

DE-21 North R.O.W T147N R15W Sec 1
Gov't
lot 5

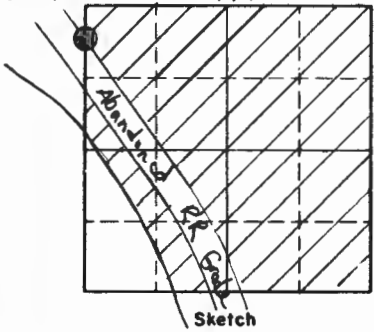

○ Corner ▨ F.S. Land

Relation of Evidence to Record Features Along Section Lines

Section line to sections	_____	_____	_____	_____
Object	_____	_____	_____	_____
Record distance	_____	_____	_____	_____
Measured distance	_____	_____	_____	_____

Other Evidence

Describe evidence of use and occupation such as roads, fences, clearings, timber cutting lines, plantations, etc.. Cite source of testimony if any. _____

At time of search:

1. Did you have the record description?

Yes No _____

2. How was search area located?

Pacing, chaining, photos, maps,
etc. Section Subdivision

3. Man hours spent in search _____

4. Do you think additional search might recover evidence? Yes _____ No

5. Signature [Signature]

Perpetuation Record

Monument and accessories established. Include brief description of area. _____

Certified corner restoration certificate prepared: Yes _____ No

Filed in county records at _____ Date _____ County Document No. ~~_____~~

Identified on aerial photo No. _____ Which is filed at _____

T. MTN R. 25 W S² P. Mer. N.F. Chippewa County Itasca State Minnesota
 Witness Corner to Mound Corner # 2 Owner common to sections 1 and 2

EXISTING SURVEYS

Original Government Survey

Year surveyed Never set

Original monument _____
(Wood post, stone, pile of stones, pipe, etc.)

Bearing Trees

Species _____

Diameter _____

Bearing _____

Distance _____

Original Evidence Found

Year of search _____ By _____

Monument found _____

Original Bearing Trees Found

Species _____

Diameter _____

Bearing _____

Distance _____

Subsequent Corner Restoration Establishment

Year surveyed Sept 1920 By L.W Johnson, Itasca Co. Surv.

Where filed or recorded County Recorder's Office

Monument iron pipe
(Original, concrete post, iron rod, etc.)

See Card DE-21
See Bk 2, PP 45

Evidence of Subsequent Corner Restoration Found

Year of search Nov 30, 1981 By K. Whitehorn, R. Oleson

Found iron pipe (1 in X 1 1/2 in) buried (and uprooted) under ice ridge. Reset IP from bearing trees, but distances seem to be backwards, Reversed distances and reset pipe and used as traverse pte This also gives with 1943 notes for Subdivision of Sec 11.

Bearing Trees, Reference Objects

Species Ash Ash _____

Diameter 10 in 9 in _____

Bearing N20°E N20°W _____

Distance 32.3 ft 26.9 ft _____

Bearing Trees, Reference Objects cut 15° East

Ash stub Ash Stub Scribe visible _____

N26°E N13°W _____

26.90 ft 32.30 ft _____

DE-21WG T144N R25W

Gov't
Lot 5
Sec. 1

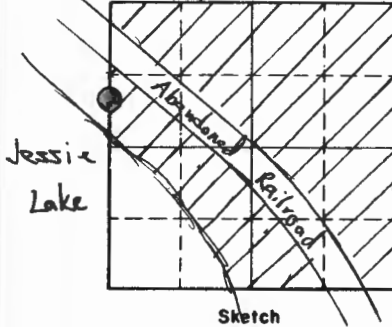

Sketch

○ Corner ▨ F.S. Land

Relation of Evidence to Record Features Along Section Lines

Section line to sections _____
 Object _____
 Record distance _____
 Measured distance _____

Other Evidence

Describe evidence of use and occupation such as roads, fences, clearings, timber cutting lines, plantations, etc.. Cite source of testimony if any. _____

At time of search:

1. Did you have the record description?
 Yes _____ No _____

2. How was search area located?
 Pacing, chaining, photos, maps,
 etc. _____

3. Man hours spent in search _____

4. Do you think additional search might
 recover evidence? Yes _____ No _____

Perpetuation Record

Monument and accessories established. Include brief description of area.
 Oct 19 1982 - set a 5/8 in X 96 inch aluminum Rod with 3/4 in aluminum cap
 down 1.0 ft in the water of Jessie Lake. Monument is stamped:

1220 Ash Stub	1920 Ash Stub	White Cedar	Black Ash	White Cedar
=	=	16.5 in	7.0 in	11.5 in
N 26° E	N 13° W	N 06° E	N 35° E	N 78° E
26.90 ft	32.30 ft	104.45 ft	37.10 ft	57.30 ft

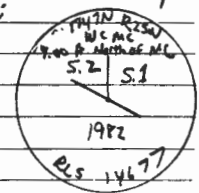

Certified corner restoration certificate prepared: Yes No _____

Filed in county records of _____ Date _____ County Document No. 357072

Identified on aerial photo No. _____ Which is filed at _____

5. Signature [Signature] 1-18-83

T. 147N R. 25W 5th Mer. N.F. Chippewa County Itasca State Minnesota
South Rd R-O-W Property Corner common to sections 1 and 2

EXISTING SURVEYS

Original Government Survey

Year surveyed _____
 Original monument _____
(Wood post, stone, pile of stones, pipe, etc.)

Bearing Trees

Species _____
 Diameter _____
 Bearing _____
 Distance _____

Original Evidence Found

Year of search _____ By _____
 Monument found _____

Original Bearing Trees Found

Species _____
 Diameter _____
 Bearing _____
 Distance _____

Subsequent Corner ~~Restoration~~ Establishment

Year surveyed Dec 9, 1982 By R. L. Whitehorn
 Where filed or recorded Itasca County Records Office
 Monument 3/8" x 36" aluminum rod with a 3/4" diam
(Original, concrete post, iron rod, etc.)
aluminum cap, 1.0 ft below the road, and stamped:

See BK 1, Pp 75

Decl: 5° East Bearing Trees, Reference Objects
 Species Cedar B. Ash
 Diameter 6.1 in 6.7 in
 Bearing N09°E N77°W
 Distance 32.30 ft 50.10 ft

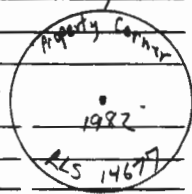

Evidence of Subsequent Corner Restoration Found

Year of search _____ By _____

Bearing Trees, Reference Objects

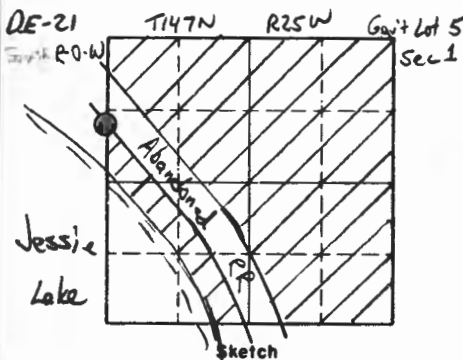

○ Corner ▨ F.S. Land

Relation of Evidence to Record Features Along Section Lines

Section line to sections _____
 Object _____
 Record distance _____
 Measured distance _____

Other Evidence

Describe evidence of use and occupation such as roads, fences, clearings, timber cutting lines, plantations, etc.. Cite source of testimony if any. _____

At time of search:

1. Did you have the record description? Yes _____ No _____

2. How was search area located? Pacing, chaining, photos, maps, etc. _____

3. Man hours spent in search _____

4. Do you think additional search might recover evidence? Yes _____ No _____

5. Signature *[Handwritten Signature]*

Perpetuation Record

Monument and accessories established. Include brief description of area. _____

Certified corner restoration certificate prepared: Yes _____ No X

Filed in county records at _____ Date _____ County Document No. _____

Identified on aerial photo No. _____ Which is filed at _____

T. 147 N R. 25 W 5th P. Mer. N.F. Chippewa County Itasca State Minnesota
Property Corner on North R.O.W. of Abandoned Railroad in Government Lot 5 of Section 1 and _____

EXISTING SURVEYS

Original Government Survey	Original Evidence Found
Year surveyed _____	Year of search _____ By _____
Original monument _____ <small>(Wood post, stone, pile of stones, pipe, etc.)</small>	Monument found _____
Bearing Trees	Original Bearing Trees Found
Species _____	Species _____
Diameter _____	Diameter _____
Bearing _____	Bearing _____
Distance _____	Distance _____
Subsequent Corner Restoration	Evidence of Subsequent Corner Restoration Found
Year surveyed <u>Dec 9, 1982</u> By <u>Ken Whitehorn, R.L.S.</u>	Year of search _____ By _____
Where filed or recorded <u>Itasca County Recorder's Office</u>	_____
Monument <u>2 in x 3 1/2 in galvanized iron pipe with 3/4 in brass tablet, flush with the ground and stamped:</u> <small>(Original, concrete base, 1/2 in dia, etc.)</small>	_____
<u>See BK 1, PP 71</u>	_____
<u>Dec 15th East</u> Bearing Trees, Reference Objects	Bearing Trees, Reference Objects
Species <u>Ash</u> <u>Ash</u>	_____
Diameter <u>6.5</u> <u>5.5 in</u>	_____
Bearing <u>N68°E</u> <u>NORTH</u>	_____
Distance <u>28.50 ft</u> <u>42.90 ft</u>	_____

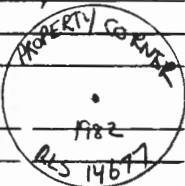

DE-21/22 North P.C. T147N R25W Sec 1

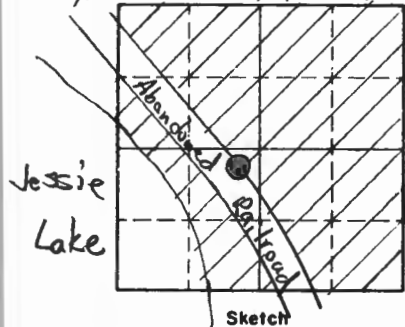

Sketch

○ Corner ▨ F.S. Land

Relation of Evidence to Record Features Along Section Lines

Section line to sections	_____	_____	_____	_____
Object	_____	_____	_____	_____
Record distance	_____	_____	_____	_____
Measured distance	_____	_____	_____	_____

Other Evidence

Describe evidence of use and occupation such as roads, fences, clearings, timber cutting lines, plantations, etc.. Cite source of testimony if any. _____

At time of search:

1. Did you have the record description?
Yes X No _____

2. How was search area located?
Pacing, chaining, photos, maps,
etc. Section Subdivision
Traverse

3. Man hours spent in search _____

4. Do you think additional search might
recover evidence? Yes _____ No X

5. Signature [Handwritten Signature]

Perpetuation Record

Monument and accessories established. Include brief description of area. _____

Certified corner restoration certificate prepared: Yes _____ No X

Filed in county records at _____ Date _____ County Document No. _____

Identified on aerial photo No. _____ Which is filed at _____

T. 147 N. R. 25 W. 5th P. Mer. N.F. Chippewa County Itasca State Minnesota
Property Corner on South R.O.W of Abandoned Railroad in Government Lot 5 of Section 1 and _____

EXISTING SURVEYS

Original Government Survey

Year surveyed _____
 Original monument _____
(Wood post, stone, pile of stones, pipe, etc.)

Bearing Trees

Species _____
 Diameter _____
 Bearing _____
 Distance _____

Original Evidence Found

Year of search _____ By _____
 Monument found _____

Original Bearing Trees Found

Species _____
 Diameter _____
 Bearing _____
 Distance _____

Subsequent Corner ~~Restoration~~ ESTABLISHMENT

Year surveyed Dec 9, 1982 By Ken Whitehorn, RLS
 Where filed or recorded Itasca County Recorder's Office
 Monument 2 in x 36 inch galvanized iron pipe with a 3/4 in
(Original, concrete post, iron rod, etc.)
brass tablet, flush with the ground and stamped:

See BK 1, PP 72

De-1: 5° East Bearing Trees, Reference Objects

Species	<u>R. Maple</u>	<u>Ash</u>
Diameter	<u>7.5 in</u>	<u>5.6 in</u>
Bearing	<u>N82°W</u>	<u>N33°W</u>
Distance	<u>42.50 ft</u>	<u>52.70 ft</u>

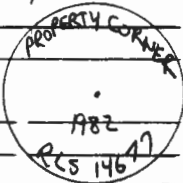

Evidence of Subsequent Corner Restoration Found

Year of search _____ By _____

Bearing Trees, Reference Objects

DE-21/22 South P.C. T147N R25W Sec. 1

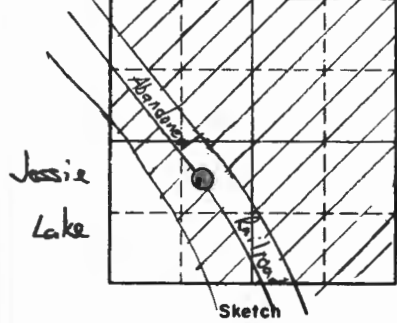

○ Corner ▨ F.S. Land

Relation of Evidence to Record Features Along Section Lines

Section line to sections	_____	_____	_____
Object	_____	_____	_____
Record distance	_____	_____	_____
Measured distance	_____	_____	_____

Other Evidence

Describe evidence of use and occupation such as roads, fences, clearings, timber cutting lines, plantations, etc.. Cite source of testimony if any. _____

At time of search:

1. Did you have the record description?

Yes No _____

2. How was search area located?

Pacing, chaining, photos, maps, etc. Section Subdivision

3. Man hours spent in search _____

4. Do you think additional search might recover evidence? Yes _____ No

5. Signature [Signature]

Perpetuation Record

Monument and accessories established. Include brief description of area. _____

Certified corner restoration certificate prepared: Yes _____ No

Filed in county records at _____ Date _____ County Document No. _____

Identified on aerial photo No. _____ Which is filed at _____

Index No. D-22
(Alphabetical - Numerical)

LAND CORNER RECORD
(RECTANGULAR SURVEYS)

RD-7150-4 (Rev. 6/13/67)
 GPO 802-127

T. 149 N. R. 25 W. 5th Mer. N.F. _____ County _____ State _____
SW 1/4 Corner common to sections 1 and _____

EXISTING SURVEYS

Original Government Survey

Year surveyed _____
 Original monument _____
(Wood post, stone, pile of stones, pipe, etc.)

Bearing Trees

Species _____
 Diameter _____
 Bearing _____
 Distance _____

Subsequent Corner Restoration

Year surveyed. 1920 By [Signature]
 Where filed or recorded Itasca Co., Pa. Warner
 Monument Iron
(Original, concrete post, iron rod, etc.)

Bearing Trees, Reference Objects

Species Birch St. SW Cor House
 Diameter 9" N42E
 Bearing N50W
 Distance 10.2' 134.7'

Original Evidence Found

Year of search _____ By _____
 Monument found _____

Original Bearing Trees Found

Species _____
 Diameter _____
 Bearing _____
 Distance _____

Evidence of Subsequent Corner Restoration Found

Year of search 1981 By R. Olsson
found Iron at record Bearing & Dist.
from S.W. Cor. of old House
2-22-83 BA, G.R.

Bearing Trees, Reference Objects

SW Cor H
145.42'

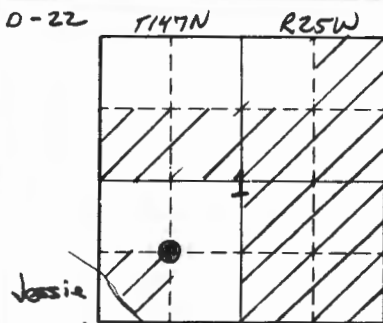

Sketch
 ○ Corner ▨ F.S. Land

Relation of Evidence to Record Features Along Section Lines

Section line to sections _____
 Object _____
 Record distance _____
 Measured distance _____

Other Evidence

Describe evidence of use and occupation such as roads, fences, clearings, timber cutting lines, plantations, etc.. Cite source of testimony if any. _____

At time of search:

1. Did you have the record description?

Yes _____ No _____

2. How was search area located?

Pacing, chaining, photos, maps, etc. _____

3. Man hours spent in search _____

4. Do you think additional search might recover evidence? Yes _____ No _____

5. Signature [Signature] RLS

Perpetuation Record

Monument and accessories established. Include brief description of area. BK2, Pp 78

Set a 2 1/2 in X 2 1/4 in aluminum monument with a 3 in Aluminum Cap 0.5 ft below the road and stamped:
 deposited 4 - 4/4 in X 6 in rebars around monument
 Dec. 6, 1982 Decl: 5° East

Red Pine	w. Birch	Balsam
8.8 in	7.1 in	6.2 in
535° E	568° W	N 68° W
62.60 ft	84.10 ft	47.20 ft

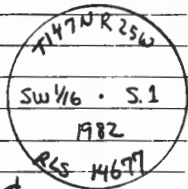

Red line south of west

Certified corner restoration certificate prepared: Yes _____ No NO

Filed in county records at _____ Date _____ County Document No. _____

Identified on aerial photo No. _____ Which is filed at _____

Index No. E-2122
(Alphabetical - Register)

LAND CORNER RECORD
(RECTANGULAR SURVEYS)

R9-7150-4 (Rev. 6/13/67)
GPO 802-127

T. 147 N R. 25 W Mer. N.F. Chippewa County Itasca State MN
Meander #3 Corner common to sections 1 and 12

EXISTING SURVEYS

Original Government Survey

Year surveyed 1875 by B.C. Falker
Original monument _____
(Wood post, stone, pile of stones, pipe, etc.)

Bearing Trees

Species _____
Diameter _____
Bearing _____
Distance _____

Subsequent Corner Restoration

Year surveyed 1920 By L.W. Johnson
Where filed or recorded _____
Monument _____
(Original, concrete post, iron rod, etc.)

Bearing Trees, Reference Objects

Species _____
Diameter _____
Bearing _____
Distance _____

Original Evidence Found

Year of search 1920 By L.W. Johnson - County Suror
Monument found _____

Original Bearing Trees Found

Species _____
Diameter _____
Bearing _____
Distance _____

Evidence of Subsequent Corner Restoration Found

Year of search 1981 By Cleber & White

Bearing Trees, Reference Objects

Species _____
Diameter _____
Bearing _____
Distance _____

E-28, 22

Section line to sections _____
 Object _____
 Record distance _____
 Measured distance _____

Other Evidence

Describe evidence of use and occupation such as roads, fences, clearings, timber cutting lines, plantations, etc.. Cite source of testimony if any. _____

Perpetuation Record

Monument and accessories established. Include brief description of area. 8/23/82
Whitehorn & Koszko Aluminum Rod monument w/Alum. Cap

Certified correct restoration, certificate prepared Yes _____ No _____

Filed in county records at _____ Date 12/14/82 County Document No. 355660

Identified on aerial photo No. _____ Which is filed at _____

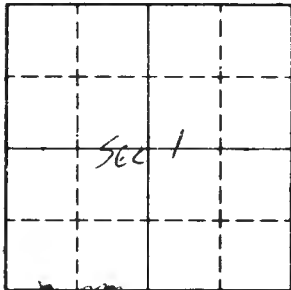

Jessie Lake

Sketch

○ Corner ▨ F.S. Land

At time of search:

1. Did you have the record description?

Yes _____ No _____

2. How was search area located?

Pacing, chaining, photos, maps, etc. _____

3. Man hours spent in search _____

4. Do you think additional search might recover evidence? Yes _____ No _____

5. Signature _____

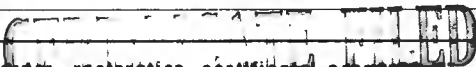

Index No. E-2122
(Alphabetical - Memorial)

LAND CORNER RECORD
(RECTANGULAR SURVEYS)

RR-7150-4 (Rev. 6/13/67)
 GPO 802-127

T. 147 N R. 25W Mer. N.F. Chippewa County ITASCA State MN
MEANDER CORNER No. 3 Corner common to sections 1 and 12

EXISTING SURVEYS

Original Government Survey

Year surveyed 1875, B.C. Baldwin
 Original monument POST
(Wood post, stone, pile of stones, pipe, etc.)

Bearing Trees

Species _____
 Diameter _____
 Bearing _____
 Distance _____

Subsequent Corner Restoration

Year surveyed _____ By _____
 Where filed or recorded _____
 Monument _____
(Original, concrete post, iron rod, etc.)

Bearing Trees, Reference Objects

Species _____
 Diameter _____
 Bearing _____
 Distance _____

Original Evidence Found

Year of search _____ By _____
 Monument found _____

Original Bearing Trees Found

Species _____
 Diameter _____
 Bearing _____
 Distance _____

Evidence of Subsequent Corner Restoration Found

Year of search _____ By _____

Bearing Trees, Reference Objects

Species _____
 Diameter _____
 Bearing _____
 Distance _____

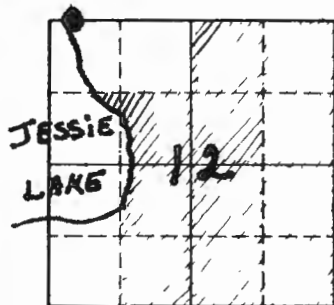

Sketch

○ Corner ▨ F.S. Land

Relation of Evidence to Record Features Along Section Lines

Section line to sections _____
 Object _____
 Record distance _____
 Measured distance _____

Other Evidence

Describe evidence of use and occupation such as roads, fences, clearings, timber cutting lines, plantations, etc.. Cite source of testimony if any. _____

At time of search:

1. Did you have the record description?

Yes No _____

2. How was search area located?

Pacing, chaining, photos, maps,
 etc. MAPS + TIES

3. Man hours spent in search 2

4. Do you think additional search might
 recover evidence? Yes _____ No

JAN 1989

5. Signature WCO

Perpetuation Record

Monument and accessories established. Include brief description of area. _____

SEE CERTIFICATE OF LOCATION OF GOVERNMENT
 CORNER FILED BY KEN WHITEHORN. RLS

Certified corner restoration certificate prepared: Yes _____ No _____

Filed in county records at ITASCA Date 11/19/84 County Document No. 355060

Identified on aerial photo No. _____ Which is filed at _____

Index No. E-21/22 WEST R-O-W
(Alphabetic - Numerical)

LAND CORNER RECORD
(RECTANGULAR SURVEYS)

R9-7150-4 (Rev. 6/13/67)
 GPO 802-127

T. 147N R. 25W S. 2P Mer. N.F. Chippewa County Itasca State Minnesota
West RR R-O-W Property Corner common to sections 1 and 12

EXISTING SURVEYS

Original Government Survey

Year surveyed
 Original monument
(Wood post, stone, pile of stones, pipe, etc.)

Bearing Trees

Species
 Diameter
 Bearing
 Distance

Original Evidence Found

Year of search By
 Monument found

Original Bearing Trees Found

Species
 Diameter
 Bearing
 Distance

Subsequent Corner ~~Restoration~~ ESTABLISHMENT

Year surveyed Dec 8, 1982 By Ken Whitehorn, RLS
 Where filed or recorded Itasca County Recorder's Office
 Monument 2 in X 3/4 in galvanized iron pipe with a 3/4 in
(Original, concrete post, iron, log, etc.)
brass tablet, flush with the ground and stamped;

See Book 2, PP 56

Decl: 5° East Bearing Trees, Reference Objects

Species Elm Poplar
 Diameter 7.2 in 3.6 in
 Bearing N77°W N35°E
 Distance 41.20 ft 13.48 ft



Evidence of Subsequent Corner Restoration Found

Year of search By

Bearing Trees, Reference Objects

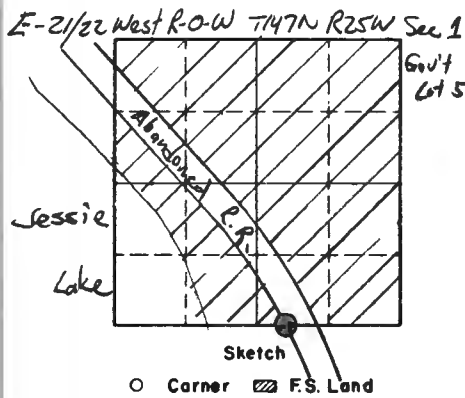

Relation of Evidence to Record Features Along Section Lines

Section line to sections _____

Object _____

Record distance _____

Measured distance _____

Other Evidence

Describe evidence of use and occupation such as roads, fences, clearings, timber cutting lines, plantations, etc.. Cite source of testimony if any. _____

At time of search:

1. Did you have the record description?

Yes _____ No _____

2. How was search area located?

Pacing, chaining, photos, maps,
etc. _____

3. Man hours spent in search _____

4. Do you think additional search might
recover evidence? Yes _____ No _____

5. Signature *[Signature]*

Perpetuation Record

Monument and accessories established. Include brief description of area. _____

Certified corner restoration certificate prepared: Yes _____ No

Filed in county records at _____ Date _____ County Document No. _____

Identified on aerial photo No. _____ Which is filed at _____

E-21/22 East ROW T147N R22SW Sec 1

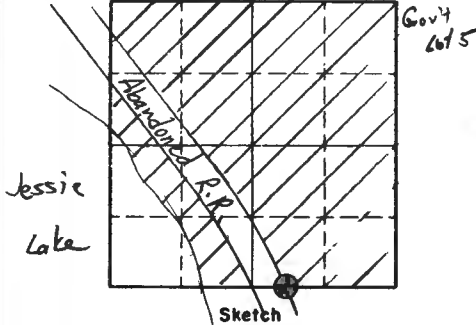

○ Corner ▨ F.S. Land

Relation of Evidence to Record Features Along Section Lines

Section line to sections	_____	_____	_____
Object	_____	_____	_____
Record distance	_____	_____	_____
Measured distance	_____	_____	_____

Other Evidence

Describe evidence of use and occupation such as roads, fences, clearings, timber cutting lines, plantations, etc.. Cite source of testimony if any. _____

At time of search:

1. Did you have the record description?

Yes _____ No _____

2. How was search area located?

Pacing, chaining, photos, maps, etc. _____

3. Man hours spent in search _____

4. Do you think additional search might recover evidence? Yes _____ No _____

Perpetuation Record

Monument and accessories established. Include brief description of area. _____

Certified corner restoration certificate prepared: Yes _____ No X

Filed in county records at _____ Date _____ County Document No. _____

Identified on aerial photo No. _____ Which is filed at _____

5. Signature [Handwritten Signature]

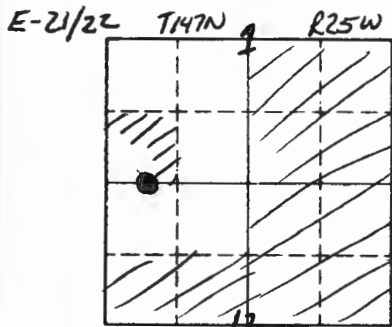

Sketch

○ Corner ▨ F.S. Land

Relation of Evidence to Record Features Along Section Lines

Section line to sections _____
 Object _____
 Record distance _____
 Measured distance _____

Other Evidence

Describe evidence of use and occupation such as roads, fences, clearings, timber cutting lines, plantations, etc.. Cite source of testimony if any. _____

At time of search:

1. Did you have the record description?

Yes _____ No _____

2. How was search area located?

Pacing, chaining, photos, maps, etc. _____

3. Man hours spent in search _____

4. Do you think additional search might recover evidence? Yes _____ No _____

5. Signature _____

Perpetuation Record

Monument and accessories established. Include brief description of area. _____

8' Steel fence Post
 with 54-9 sign
 west
 20 ft

All BT's painted Red & have 60d spike in base blaze

Certified corner restoration certificate prepared: Yes No _____

Filed in county records at Itasca Co Date 12-14-82 County Document No. 355060

Identified on aerial photo No. _____ Which is filed at _____

Index No. E-22
(Alphabetical - Numerical)

LAND CORNER RECORD
(RECTANGULAR SURVEYS)

R9-7150-4 (Rev. 6/13/67)
GPO 802-127

T. 147 R. 25 Mer. N.F. _____ County _____ State _____
West 1/4 Corner common to sections 1, 12 and _____

EXISTING SURVEYS

Original Government Survey

Year surveyed _____

Original monument _____
(Wood post, stone, pile of stones, pipe, etc.)

Bearing Trees

Species _____

Diameter _____

Bearing _____

Distance _____

Original Evidence Found

Year of search _____ By _____

Monument found _____

Original Bearing Trees Found

Species _____

Diameter _____

Bearing _____

Distance _____

Subsequent Corner Restoration

Year surveyed 1920 By Itasca Co. P.S. Warner

Where filed or recorded _____

Monument Iron
(Original, concrete post, iron rod, etc.)

Evidence of Subsequent Corner Restoration Found

Year of search 1981 By R. Oleson

found
None

Bearing Trees, Reference Objects

Species Elm Elm

Diameter 17" 7"

Bearing N65E S1W

Distance 28.15 22.3

Bearing Trees, Reference Objects

found
None

E-22

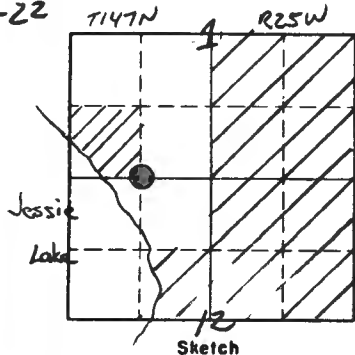

○ Corner ▨ F.S. Land

Relation of Evidence to Record Features Along Section Lines

Section line to sections _____
 Object _____
 Record distance _____
 Measured distance _____

Other Evidence

Describe evidence of use and occupation such as roads, fences, clearings, timber cutting lines, plantations, etc.. Cite source of testimony if any. _____

At time of search:

1. Did you have the record description?

Yes _____ No _____

2. How was search area located?

Pacing, chaining, photos, maps, etc. _____

3. Man hours spent in search _____

4. Do you think additional search might recover evidence? Yes _____ No _____

5. Signature [Signature] RS

Perpetuation Record

Monument and accessories established. Include brief description of area. **BK2, PP 70**

2 in x 60 in galv IP with 3 in diameter brass tablet, up 1.6 ft & stamped
Nov 23, 1982

Black Ash	Black Ash	Black Ash
6.0 in	9.9 in	11.3 in
N07°E	S70°E	N64°W
32.50 ft	47.60 ft	22.80 ft

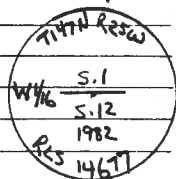

Decl: 5° East

Red line North and west

Certified corner restoration certificate prepared: Yes _____ No NO

Filed in county records at _____ Date _____ County Document No. _____

Identified on aerial photo No. _____ Which is filed at _____

Index No. E-22
(Alphabetical - Numerical)

LAND CORNER RECORD
(RECTANGULAR SURVEYS)

R9-7150-4 (Rev. 6/13/67)
GPO 802-127

T. 147 N R. 25 W 5TH Mer. N.F. CHIPPEWA County ITASCA State MN
W 1/16 Corner common to sections 1 and 12

EXISTING SURVEYS

Original Government Survey

Year surveyed _____
Original monument _____
(Wood post, stone, pile of stones, pipe, etc.)

Bearing Trees

Species _____
Diameter _____
Bearing _____
Distance _____

Subsequent Corner Restoration

Year surveyed _____ By _____
Where filed or recorded _____
Monument _____
(Original, concrete post, iron rod, etc.)

Bearing Trees, Reference Objects

Species _____
Diameter _____
Bearing _____
Distance _____

Original Evidence Found

Year of search _____ By _____
Monument found _____

Original Bearing Trees Found

Species _____
Diameter _____
Bearing _____
Distance _____

Evidence of Subsequent Corner Restoration Found

Year of search 1981 By R. Oleson
Found none

Bearing Trees, Reference Objects

Species _____
Diameter _____
Bearing _____
Distance _____

JESSIE
LAKE

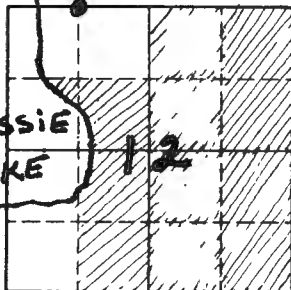

Sketch

○ Corner ▨ F.S. Land

Relation of Evidence to Record Features Along Section Lines

Section line to sections _____
Object _____
Record distance _____
Measured distance _____

Other Evidence

Describe evidence of use and occupation such as roads, fences, clearings, timber cutting lines, plantations, etc.. Cite source of testimony if any. _____

USFS RED LINE TO EAST + WEST
CORNER IS APPROXIMATELY 175 FEET EAST OF
COUNTY ROAD

At time of search:

1. Did you have the record description?

Yes No _____

2. How was search area located?

Pacing, chaining, photos, maps,
etc. MAPS + TIES

3. Man hours spent in search 1

4. Do you think additional search might
recover evidence? Yes _____ No

JAN 1989

5. Signature WCO

Perpetuation Record

Monument and accessories established. Include brief description of area. _____

10-11-88 PERSONNEL FROM KOVANEN + OSOFSEN
SURVEYORS FIND USFS MONUMENT AND BT'S AS
PER 1984. CERTIFICATE OF SURVEY OF SECTION
1, DOC. NO. 368789

Certified corner restoration certificate prepared: Yes _____ No

Filed in county records at ITASCA Date 11/20/84 County Document No. 368789

Identified on aerial photo No. _____ Which is filed at _____

Index No. E-23
(Alphabetical - Numerical)

LAND CORNER RECORD
(RECTANGULAR SURVEYS)

RD-7150-4 (Rev. 6/13/67)
GPO 802-127

T. 147N R. 25W 1/4 5TH Mer. N.F. Chippewa County Itasca State MN
Corner common to sections 1 and 12

EXISTING SURVEYS

Original Government Survey

Year surveyed 1875 B.C. BALDWIN
Original monument POST
(Wood post, stone, pile of stones, pipe, etc.)

Bearing Trees

Species _____
Diameter _____
Bearing _____
Distance _____

Subsequent Corner Restoration

Year surveyed _____ By _____
Where filed or recorded _____
Monument _____
(Original, concrete post, iron rod, etc.)

Bearing Trees, Reference Objects

Species _____
Diameter _____
Bearing _____
Distance _____

Original Evidence Found

Year of search _____ By _____
Monument found _____

Original Bearing Trees Found

Species _____
Diameter _____
Bearing _____
Distance _____

Evidence of Subsequent Corner Restoration Found

Year of search _____ By _____

Bearing Trees, Reference Objects

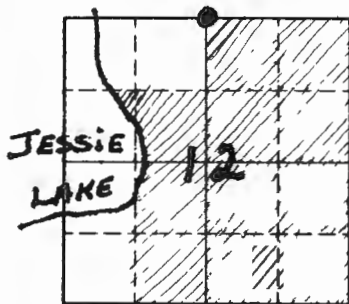

Sketch

○ Corner ▨ F.S. Land

Relation of Evidence to Record Features Along Section Lines

Section line to sections _____
 Object _____
 Record distance _____
 Measured distance _____

Other Evidence

Describe evidence of use and occupation such as roads, fences, clearings, timber cutting lines, plantations, etc.. Cite source of testimony if any. _____

At time of search:

1. Did you have the record description?
 Yes No _____

2. How was search area located?
 Pacing, chaining, photos, maps,
 etc. MAPS + TIES

3. Man hours spent in search 2

4. Do you think additional search might
 recover evidence? Yes _____ No

JAN 1989

5. Signature WCO

Perpetuation Record

Monument and accessories established. Include brief description of area. _____

SEE CERTIFICATE OF LOCATION OF GOVERNMENT
 CORNER FILED BY KEN WHITEHORN RLS

Certified corner restoration certificate prepared: Yes _____ No _____
 Filed in county records at ITASCA Date 11/19/84 County Document No. 355063
 Identified on aerial photo No. _____ Which is filed at _____

Index No. E-23
(Alphabetical - Numerical)

LAND CORNER RECORD
(RECTANGULAR SURVEYS)

R9-7150-4 (Rev. 6/13/67)
 GPO 602-127

T. 147N R. 25W 5th P. Mer. N.F. Chippewa County Itasca State Minnesota
South Quarter Corner common to sections 1 and 12

EXISTING SURVEYS

Original Government Survey	Original Evidence Found
Year surveyed _____	Year of search _____ By _____
Original monument _____ <small>(Wood post, stone, pile of stones, pipe, etc.)</small>	Monument found _____
Bearing Trees	Original Bearing Trees Found
Species _____	Species _____
Diameter _____	Diameter _____
Bearing _____	Bearing _____
Distance _____	Distance _____

Subsequent Corner Restoration	Evidence of Subsequent Corner Restoration Found
Year surveyed <u>Aug 23, 1982</u> By <u>Ken Whitehorn, RLS</u>	Year of search _____ By _____
Where filed or recorded <u>Itasca Co Courthouse</u>	_____
Monument <u>2 inch x 30 inch with with Aluminum</u> <small>(Original: concrete post, iron rod, etc.)</small>	_____
<u>Monument stamped</u> <u>147N R25W</u> <u>3/4</u> <u>S.1</u>	_____

1920 Bearing Trees, Reference Objects S.12			Bearing Trees, Reference Objects		
Species <u>Cash Pine</u>	<u>W. Birch</u>	<u>h. Oak</u>	<u>1982</u>	_____	_____
Diameter <u>18 inch</u>	<u>6.5 inch</u>	<u>8.0 inch</u>	<u>RLS 14677</u>	_____	_____
Bearing <u>N42 1/2° E</u>	<u>S82 E</u>	<u>S37° E</u>	_____	_____	_____
Distance <u>86.00</u>	<u>37.70 ft</u>	<u>77.90 ft</u>	_____	_____	_____
<u>to face of blaze</u>	<u>to 1/2 nail</u>	<u>to 1/2 nail</u>	_____	_____	_____

E-23 T147N R25W

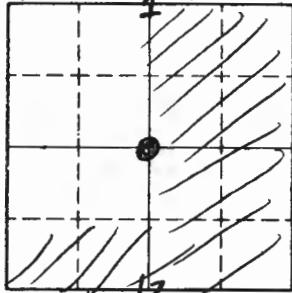

Sketch

○ Corner ▨ F.S. Land

Relation of Evidence to Record Features Along Section Lines

Section line to sections _____

Object _____

Record distance _____

Measured distance _____

Other Evidence

Describe evidence of use and occupation such as roads, fences, clearings, timber cutting lines, plantations, etc.. Cite source of testimony if any. _____

At time of search:

1. Did you have the record description?

Yes _____ No _____

2. How was search area located?

Pacing, chaining, photos, maps, etc. _____

3. Man hours spent in search _____

4. Do you think additional search might recover evidence? Yes _____ No _____

5. Signature _____

Perpetuation Record

Monument and accessories established. Include brief description of area. _____

8' Steel fence post with WSFS #34-9 attached
post 2.0 ft

All BT's painted red with 60d spike in Baseplate

Certified corner restoration certificate prepared: Yes No _____

Filed in county records at Itasca Co Date 12-14-82 County Document No. 355063

Identified on aerial photo No. _____ Which is filed at _____

Index No. E-25
(Alphabetical-Numerical)

LAND CORNER RECORD
(RECTANGULAR SURVEYS)

R9-7150-4 (Rev. 6/13/67)
GPO 502-127

T. 147N R. 25W 5th P. Mer. N.F. Chippewa County Itasca State Minnesota
Standard Section Corner common to sections 1 and 12

EXISTING SURVEYS

Original Government Survey

Year surveyed May 31, 1867 George E. Stantz
Original monument post
(Solid post, stone, pile of stones, pipe, etc.)

Bearing Trees

Species	<u>Spruce</u>	<u>Spruce</u>		
Diameter	<u>3 inch</u>	<u>6 inch</u>		
Bearing	<u>N 21° W</u>	<u>S 10° W</u>		
Distance	<u>24 lks</u>	<u>35 lks</u>		
	<u>15.84 ft</u>	<u>23.10 ft</u>		

Subsequent Corner Restoration

Year surveyed unknown By Road Engineer Itasca Co
Where filed or recorded —
Monument —
(Original, concrete post, iron rod, etc.)

Bearing Trees, Reference Objects

Species	<u>unknown</u>	<u>unknown</u>	<u>unknown</u>	<u>unknown</u>
Diameter				
Bearing				
Distance				

Original Evidence Found

Year of search unknown By Road Engineer, Itasca Co.
Monument found —

Original Bearing Trees Found

Species	<u>unknown</u>			
Diameter				
Bearing				
Distance				

Evidence of Subsequent Corner Restoration Found

Year of search 1920 By L.W. Johnson, Itasca Co.
Surveyor. Note state: "i.e. the cor of 1 & 12 on range line found 4 B.T. set by road engineer also found 1 gov't stp on side of road has been grubbed out."

Bearing Trees, Reference Objects

<u>Tan Stp</u>	<u>Spruce</u>	<u>Poplar</u>	<u>Tan Stp</u>
<u>10 inch</u>	<u>6 inch</u>	<u>12 inch</u>	<u>12 inch</u>
<u>N 60° E</u>	<u>S 60° E</u>	<u>S 45° W</u>	<u>N 60° W</u>
<u>51.5 ft</u>	<u>64.5 ft</u>	<u>70.9 ft</u>	<u>65.9 ft</u>

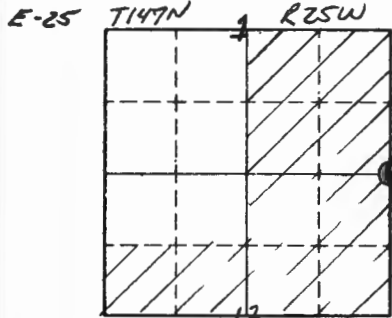

Sketch

○ Corner ▨ F.S. Land

Relation of Evidence to Record Features Along Section Lines

Section line to sections _____
 Object _____
 Record distance _____
 Measured distance _____

Other Evidence

Describe evidence of use and occupation such as roads, fences, clearings, timber cutting lines, plantations, etc.. Cite source of testimony if any.

11-21-33 : N. L. Pladdy, CCC Estimator - found old scribed post and a 16 inch Tamarack Stump, N45°W, 60 ft x (39.60 ft)
 circa 1969 : Itasca County Surveyor's Office, set 9/4 inch IP, prolated, 3 inch Cedar, S64°W, 35.33 ft and 6 inch spruce N70°W, 49.40 ft

At time of search:

1. Did you have the record description?

Yes No _____

2. How was search area located?

Pacing, chaining, photos, maps, etc. _____

3. Man hours spent in search _____

4. Do you think additional search might recover evidence? Yes _____ No _____

5. Signature _____

Perpetuation Record

Monument and accessories established. Include brief description of area.

Nov 18, 1991 - find iron pipe old cedar post with location poster.
 See Book 2, pp 43 T147NR25W.

6. Cedar 5.5 inch	Tamarack
N65°W	8.2 inch
35.40 ft	S76°W
	49.38 ft

Certified corner restoration certificate prepared: Yes _____ No _____

Filed in county records at _____ Date _____ County Document No. _____

Identified on aerial photo No. _____ Which is filed at _____

Index No. G-25
(Alphabetical - Numerical)

LAND CORNER RECORD
(RECTANGULAR SURVEYS)

R9-7150-4 (Rev. 6/13/67)
GPO 802-127

T. 147N R. 25W 5TH Mer. N.F. CHIPPEWA County ITASCA State MN
SC 14 Corner common to sections 12 and _____

EXISTING SURVEYS

Original Government Survey

Year surveyed 1867, G.R. & G.E. STUNTZ
Original monument POST
(Wood post, stone, pile of stones, pipe, etc.)

Bearing Trees

Species	<u>Y. PINE</u>	<u>Y. PINE</u>
Diameter	<u>6"</u>	<u>12"</u>
Bearing	<u>N 50° W</u>	<u>S 30° W</u>
Distance	<u>25 LKS</u>	<u>30 LKS</u>
	<u>16.50'</u>	<u>19.80'</u>

Subsequent Corner Restoration

Year surveyed 1967 By ITASCA COUNTY SURVEYORS
Where filed or recorded SURVEYORS OFFICE
Monument SET 3/4" I.D. PIPE IN ROAD
(Original, concrete post, iron rod, etc.)
2' W. E. T. of CENTERLINE HWY #6

Bearing Trees, Reference Objects

Species	<u>J. PINE</u>	<u>J. PINE</u>
Diameter	<u>8"</u>	<u>7"</u>
Bearing	<u>N 80° W</u>	<u>S 48° W</u>
Distance	<u>55.11'</u>	<u>79.18'</u>

Original Evidence Found

Year of search 1913 By R.K. BLIKER
Monument found NOT MENTIONED - SHOWS NEW BT'S

Original Bearing Trees Found

Species	<u>PINE STP.</u>	<u>PINE STP.</u>
Diameter	<u>-</u>	<u>-</u>
Bearing	<u>S 75° W</u>	<u>N 73° W</u>
Distance	<u>82.0'</u>	<u>63.5'</u>

Evidence of Subsequent Corner Restoration Found

Year of search 10-11-88 By K+O SURVEYORS
FIND 1967 1/2" & 3/4" PIPE DOWN 7"
BELOW ROAD SURFACE.

Bearing Trees, Reference Objects

Species		
Diameter		
Bearing		
Distance		

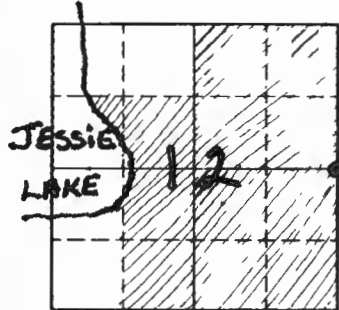

Sketch

○ Corner ▨ F.S. Land

Relation of Evidence to Record Features Along Section Lines

Section line to sections _____
 Object _____
 Record distance _____
 Measured distance _____

Other Evidence

Describe evidence of use and occupation such as roads, fences, clearings, timber cutting lines, plantations, etc.. Cite source of testimony if any. _____

CORNER IS APPROXIMATE 2 FEET WEST OF CENTERLINE
Highway No. 6

At time of search:

1. Did you have the record description?

Yes No _____

2. How was search area located?

Pacing, chaining, photos, maps,
 etc. MAP + TIES

3. Man hours spent in search 1

4. Do you think additional search might
 recover evidence? Yes _____ No

JAN 1989

5. Signature WCO

Perpetuation Record

Monument and accessories established. Include brief description of area. _____

1-17-89 PERSONNEL FROM KOVANEN + OSOFSEN SURVEYORS
ADD 3" BRASS CAP TO EXISTING IRON PIPE AND BRING
WITNESSES TO USFS STANDARD

JACK PINE 12" N38°W, 52.62 FEET

JACK PINE 12" N79°W, 55.44 FEET

JACK PINE 12" N50°W, 79.50 FEET

8 FEET LONG STEEL SIGN POST WITH 54-9 SIGN- WEST, 27.50'

Certified corner restoration certificate prepared: Yes No _____

Filed in county records at ITASCA Date _____ County Document No. _____

Identified on aerial photo No. _____ Which is filed at _____

Index No. 64-21
(Alphabetical - Numerical)

LAND CORNER RECORD
(RECTANGULAR SURVEYS)

RP-7 150-4 (Rev. 6/13/67)
 GPO 502-127

T. 147N R. 25W 5TH Mer. N.F. CHIPPEWA County ITASCA State MN
 Corner common to sections 11 and 12

EXISTING SURVEYS

Original Government Survey

Year surveyed 1875, B. C. BALDWIN
 Original monument POST
(Wood post, stone, pile of stones, pipe, etc.)

Bearing Trees

Species NO TREES
 Diameter _____
 Bearing _____
 Distance _____

Subsequent Corner Restoration

Year surveyed 1943 By P. C. WARNER
 Where filed or recorded ITASCA COUNTY SURVEYORS OFFICE
 Monument IRON PIPE - AMC - ORIGINAL
(Original, concrete post, iron rod, etc.)
POSITION WOULD BE APPROXIMATE
235' TO LAKE.

Bearing Trees, Reference Objects

Species NO TREES
 Diameter _____
 Bearing _____
 Distance _____

Original Evidence Found

Year of search _____ By _____
 Monument found _____

Original Bearing Trees Found

Species _____
 Diameter _____
 Bearing _____
 Distance _____

Evidence of Subsequent Corner Restoration Found

Year of search _____ By _____

Bearing Trees, Reference Objects

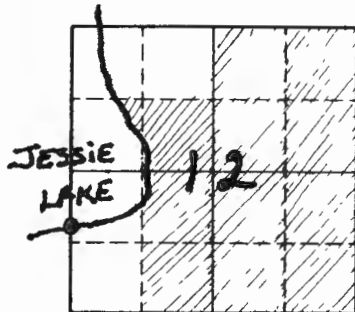

Sketch

○ Corner ▨ F.S. Land

Relation of Evidence to Record Features Along Section Lines

Section line to sections _____
 Object _____
 Record distance _____
 Measured distance _____

Other Evidence

Describe evidence of use and occupation such as roads, fences, clearings, timber cutting lines, plantations, etc.. Cite source of testimony if any. _____

At time of search:

1. Did you have the record description?

Yes No _____

2. How was search area located?

Pacing, chaining, photos, maps,
 etc. TRAVERSE

3. Man hours spent in search 2

4. Do you think additional search might
 recover evidence? Yes _____ No

JAN 1989

5. Signature WCO

Perpetuation Record

Monument and accessories established. Include brief description of area. _____

10-12-88 PERSONNEL FROM KOVANEN & OSUFSEN SURVEYORS
 SEARCH FOR 1943 POSITION AS ORIGINAL FALLS IN LAKE.
 FIND NOTHING. ON 1-20-89 WE SET A 14' LONG ALUMINUM
 ROD MONUMENT WITH CAP FOR AMC. AN 8' LONG STEEL
 SIGN POST WITH 54-9 SIGN BEARS NORTH 4.33 FEET.
 OPEN MARSH - NO TREES

Certified corner restoration certificate prepared: Yes No _____

Filed in county records at ITASCA Date _____ County Document No. _____

Identified on aerial photo No. _____ Which is filed at _____

Index No. G.H-22
(Alphabetical - Numerical)

LAND CORNER RECORD
(RECTANGULAR SURVEYS)

R9-7150-4 (Rev. 6/13/67)
GPO 802-127

T. 147 N R. 25 W 5TH Mer. N.F. CHIPPEWA County ITASCA State MN
SMC W 1/16 LINE Corner common to sections 12 and _____

EXISTING SURVEYS

Original Government Survey

Year surveyed _____
Original monument _____
(Wood post, stone, pile of stones, pipe, etc.)

Bearing Trees

Species _____
Diameter _____
Bearing _____
Distance _____

Subsequent Corner Restoration

Year surveyed 1984 By USFS
Where filed or recorded ITASCA COUNTY RECORDER
Monument USFS ALUMINUM ROD MONUMENT
(Original, concrete post, iron rod, etc.)

Bearing Trees, Reference Objects

Species _____
Diameter _____
Bearing _____
Distance _____

Original Evidence Found

Year of search _____ By _____
Monument found _____

Original Bearing Trees Found

Species _____
Diameter _____
Bearing _____
Distance _____

Evidence of Subsequent Corner Restoration Found

Year of search _____ By _____

Bearing Trees, Reference Objects

Species _____
Diameter _____
Bearing _____
Distance _____

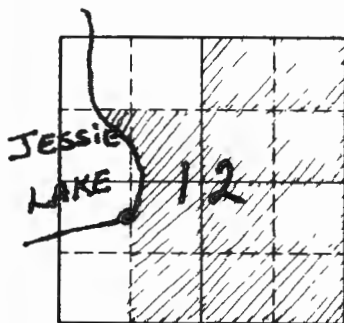

Sketch

○ Corner ▨ F.S. Land

Relation of Evidence to Record Features Along Section Lines

Section line to sections _____
 Object _____
 Record distance _____
 Measured distance _____

Other Evidence

Describe evidence of use and occupation such as roads, fences, clearings, timber cutting lines, plantations, etc.. Cite source of testimony if any. _____

MONUMENT ON SE SHORE OF JESSIE LAKE
 REDLINE TO SOUTH

At time of search:

1. Did you have the record description?

Yes _____ No _____

2. How was search area located?

Pacing, chaining, photos, maps,
 etc. _____

3. Man hours spent in search _____

4. Do you think additional search might
 recover evidence? Yes _____ No _____

5. Signature _____

Perpetuation Record

Monument and accessories established. Include brief description of area. _____

1-20-89 PERSONNEL FROM KOVANEN & OSUFSEN SURVEYORS
 FIND USFS ALUMINUM CAP. ROD MONUMENT AS SET BY
 USFS ON 5-21-84 AND THE FOLLOWING WITNESSES.
 ASH 6.6" S40°E 53.46 feet
 ASH 9.6" S05°E 79.80 feet
 8' METAL SIGN POST SOUTH 3.0 FT WITH 54-2 &
 54-9 SIGNS.

Certified corner restoration certificate prepared: Yes _____ No

Filed in county records at _____ Date _____ County Document No. _____

Identified on aerial photo No. _____ Which is filed at _____

Index No. H-21
(Alphabetical - Numerical)

LAND CORNER RECORD
(RECTANGULAR SURVEYS)

R9-7150-4 (Rev. 6/13/67)
 GPO 802-127

T. 147N R. 25W 5TH Mer. N.F. Chippewa County ITASCA State MN
S 1/16 Corner common to sections 11 and 12

EXISTING SURVEYS

Original Government Survey	Original Evidence Found
Year surveyed _____ Original monument _____ <small>(Wood post, stone, pile of stones, pipe, etc.)</small>	Year of search _____ By _____ Monument found _____
<p style="text-align: center;">Bearing Trees</p> Species _____ Diameter _____ Bearing _____ Distance _____	<p style="text-align: center;">Original Bearing Trees Found</p> Species _____ Diameter _____ Bearing _____ Distance _____
<p style="text-align: center;">Subsequent Corner Restoration</p> Year surveyed _____ By _____ Where filed or recorded _____ Monument _____ <small>(Original, concrete post, iron rod, etc.)</small>	<p style="text-align: center;">Evidence of Subsequent Corner Restoration Found</p> Year of search _____ By _____ _____ _____ _____
<p style="text-align: center;">Bearing Trees, Reference Objects</p> Species _____ Diameter _____ Bearing _____ Distance _____	<p style="text-align: center;">Bearing Trees, Reference Objects</p> _____ _____ _____ _____

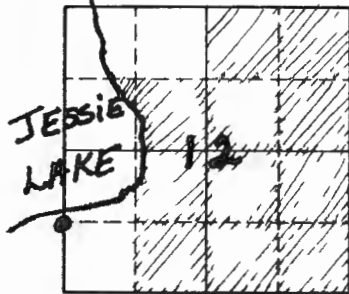

Sketch

○ Corner ▨ F.S. Land

Relation of Evidence to Record Features Along Section Lines

Section line to sections _____
 Object _____
 Record distance _____
 Measured distance _____

Other Evidence

Describe evidence of use and occupation such as roads, fences, clearings, timber cutting lines, plantations, etc.. Cite source of testimony if any. CORNER IN OPEN MARSH USES ALUMINUM ROD MONUMENT - RED LINE TO SOUTH

At time of search:

1. Did you have the record description?

Yes No _____

2. How was search area located?

Pacing, chaining, photos, maps, etc. MAPS + TIES

3. Man hours spent in search 1

4. Do you think additional search might recover evidence? Yes _____ No

JAN 1989

5. Signature WCO

Perpetuation Record

Monument and accessories established. Include brief description of area. 10-12-88 PERSONNEL FROM KOVANEN + OSUFSEN SURVEYORS FIND USFS MONUMENT AND SIGN posts AS PER 1984 CERTIFICATE OF SURVEY DOC. NO. 368789

Certified corner restoration certificate prepared: Yes _____ No
 Filed in county records at ITACA Date 11/20/84 County Document No. 368789
 Identified on aerial photo No. _____ Which is filed at _____

Index No. J-6 (Alphabetical - Numerical) **BOOK # 1** LAND CORNER RECORD (RECTANGULAR SURVEYS) R9-7 150-4 (Rev. 6/13/67) GPO 602-127
PAGE # 39
5-TH
 T. 147N R. 25W Mer. N.F. _____ County _____ State _____
W 1/16 Corner common to sections _____, _____, _____ and _____

EXISTING SURVEYS

Original Government Survey	Original Evidence Found
Year surveyed _____ Original monument _____ <small>(Wood post, stone, pile of stones, pipe, etc.)</small>	Year of search _____ By _____ Monument found _____
<p style="text-align: center;">Bearing Trees</p> Species _____ Diameter <u>Needle Field work</u> Bearing _____ Distance _____	<p style="text-align: center;">Original Bearing Trees Found</p> Species _____ Diameter _____ Bearing _____ Distance _____
<p style="text-align: center;">Subsequent Corner Restoration</p> Year surveyed _____ By _____ Where filed or recorded _____ Monument _____ <small>(Original, concrete post, iron rod, etc.)</small>	<p style="text-align: center;">Evidence of Subsequent Corner Restoration Found</p> Year of search _____ By _____ _____ _____ _____
<p style="text-align: center;">Bearing Trees, Reference Objects</p> Species _____ Diameter _____ Bearing _____ Distance _____	<p style="text-align: center;">Bearing Trees, Reference Objects</p> _____ _____ _____ _____

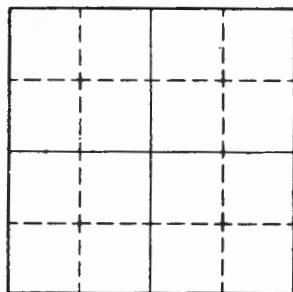

Sketch

○ Corner ▨ F.S. Land

Relation of Evidence to Record Features Along Section Lines

Section line to sections _____

Object _____

Record distance _____

Measured distance _____

Other Evidence

Describe evidence of use and occupation such as roads, fences, clearings, timber cutting lines, plantations, etc.. Cite source of testimony if any. _____

At time of search:

1. Did you have the record description?

Yes _____ No _____

2. How was search area located?

Pacing, chaining, photos, maps, etc. _____

3. Man hours spent in search _____

4. Do you think additional search might

recover evidence? Yes _____ No _____

Certified corner restoration certificate prepared: Yes _____ No _____

Filed in county records at _____ Date _____ County Document No. _____

5. Signature _____

Identified on aerial photo No. _____ Which is filed at _____

Index No. J-7
(Alphabetical - Numerical)

LAND CORNER RECORD
(RECTANGULAR SURVEYS)

R9-7150-4 (Rev. 6/13/67)
 GPO 806-924

T. 147 R. 25 5th Mer. N.F. Chippewa County Stasca State MINN.
Quarter Corner common to sections 8, 17, and _____

EXISTING SURVEYS

Original Government Survey	Original Evidence Found
Year surveyed _____	Year of search _____ By _____
Original monument _____ <small>(Wood post, stone, pile of stones, pipe, etc.)</small>	Monument found _____
Bearing Trees	Original Bearing Trees Found
Species _____	Species _____
Diameter _____	Diameter _____
Bearing _____	Bearing _____
Distance _____	Distance _____
Subsequent Corner Restoration	Evidence of Subsequent Corner Restoration Found
Year surveyed. <u>1971</u> By _____	Year of search _____ By _____
Where filed or recorded _____	_____
Monument <u>I.P.</u> <small>(Original, concrete post, iron rod, etc.)</small>	_____
<u>NAILS IN BEARING TREES</u>	_____
Bearing Trees, Reference Objects	Bearing Trees, Reference Objects
Species <u>Basswood</u> <u>Maple</u>	_____
Diameter <u>Clump</u> <u>10"</u>	_____
Bearing <u>N30E</u> <u>N50W</u>	_____
Distance <u>43.70'</u> <u>55.60'</u>	_____

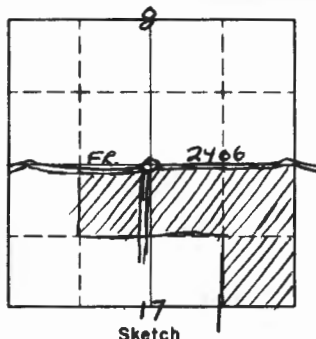

Sketch

○ Corner ▨ F.S. Land

Relation of Evidence to Record Features Along Section Lines

Section line to sections _____
 Object _____
 Record distance _____
 Measured distance _____

Other Evidence

Describe evidence of use and occupation such as roads, fences, clearings, timber cutting lines, plantations, etc.. Cite source of testimony if any. _____

Perpetuation Record

Monument and accessories established. Include brief description of area. _____

Certified corner restoration certificate prepared: Yes _____ No _____

Filed in county records at _____ Date _____ County Document No. _____

Identified on aerial photo No. _____ Which is filed at _____

- At time of search:
1. Did you have the record description?
 Yes _____ No _____
 2. How was search area located?
 Pacing, chaining, photos, maps, etc. _____
 3. Man hours spent in search _____
 4. Do you think additional search might recover evidence? Yes _____ No _____
 5. Signature _____

Index No. J-14
(Alphabetical - Numerical)LAND CORNER RECORD
(RECTANGULAR SURVEYS)R9-7150-4 (Rev. 6/13/67)
GPO 802-127T. 147 N. R. 25 W 5th Mer. N.F. Chippewa County Itasca State Minn
West 116 Corner common to sections 10 15 and _____

EXISTING SURVEYS

Original Government Survey

Year surveyed _____

Original monument _____
(Wood post, stone, pile of stones, pipe, etc.)

Bearing Trees

Species _____

Diameter _____

Bearing _____

Distance _____

Subsequent Corner Restoration

Year surveyed 1938 By County Rd SurveyWhere filed or recorded County Court HouseMonument Iron
(Original, concrete post, iron rod, etc.)

Bearing Trees, Reference Objects

Species Maple 51mDiameter 14" 24"Bearing S 45 E S 39 EDistance 13.6' 29.1'

Original Evidence Found

Year of search _____ By _____

Monument found _____

Original Bearing Trees Found

Species _____

Diameter _____

Bearing _____

Distance _____

Evidence of Subsequent Corner Restoration Found

Year of search 1976 By P. OlesenFound Iron Pipe

Bearing Trees, Reference Objects

Species Maple _____Diameter 16" _____Bearing S 45 E _____Distance 13.6' _____

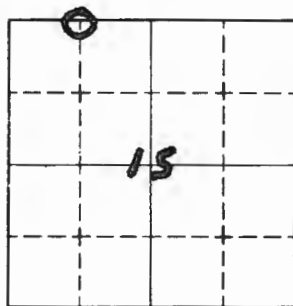

Sketch

○ Corner ▨ F.S. Land

Relation of Evidence to Record Features Along Section Lines

Section line to sections _____
 Object _____
 Record distance _____
 Measured distance _____

Other Evidence

Describe evidence of use and occupation such as roads, fences, clearings, timber cutting lines, plantations, etc.. Cite source of testimony if any. _____

At time of search:

1. Did you have the record description?

Yes No _____

2. How was search area located?

Pacing, chaining, photos, maps, etc. _____

3. Man hours spent in search _____

4. Do you think additional search might recover evidence? Yes _____ No _____

5. Signature Ronald O. [unclear]

Perpetuation Record

Monument and accessories established. Include brief description of area.

I put up Bearing Tree Tag on 16" Maple
 13.6' S 85 E of Cur

4/15/76

Certified corner restoration certificate prepared: Yes _____ No _____

Filed in county records at _____ Date _____ County Document No. _____

Identified on aerial photo No. _____ Which is filed at _____

Index No. J-19
(Alphabetical - Numerical)

LAND CORNER RECORD
(RECTANGULAR SURVEYS)

R9-7150-4 (Rev. 6/13/67)
 GPO 502-127

T. 147N R. 25W 5thP Mer. N.F. Chippewa County Itasca State Minnesota
Quarter Corner common to sections 11 and 14

EXISTING SURVEYS

Original Government Survey

Year surveyed Dec 1875 B. C. Baldwin

Original monument _____
(Wood post, stone, pile of stones, pipe, etc.)

Bearing Trees

Species _____

Diameter _____

Bearing _____

Distance _____

Original Evidence Found

Year of search _____ By _____

Monument found _____

Original Bearing Trees Found

Species _____

Diameter _____

Bearing _____

Distance _____

Subsequent Corner Restoration

Year surveyed Dec 1913 1913 By Itasca Co.

Where filed or recorded Courthouse

Monument iron pipe
(Original, concrete post, wax rod, etc.)

Evidence of Subsequent Corner Restoration Found

Year of search Apr 28, 1922 By K. Whitehorn, RLS

find iron pipe

Bearing Trees, Reference Objects

Species	<u>Balsam</u>	<u>Poplar Stp</u>	<u>Poplar</u>	<u>Y. Birch</u>
Diameter	<u>8 in.</u>	<u>14 in</u>	<u>12 in</u>	<u>12</u>
Bearing	<u>N06 E</u>	<u>S21 W</u>	<u>S18 W</u>	<u>N69 W</u>
Distance	<u>36.3 ft</u>	<u>27.8 ft</u>	<u>37.2 ft</u>	<u>73.2 ft</u>

Bearing Trees, Reference Objects

			<u>Y. Birch Stp</u>
			<u>-</u>
			<u>N67 1/2 W</u>
			<u>94.30 ft</u>

J-19

T147N 1/4 R25W

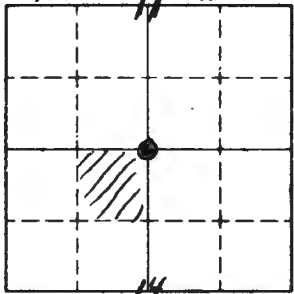

Sketch

○ Corner ▨ F.S. Land

Relation of Evidence to Record Features Along Section Lines

Section line to sections _____

Object _____

Record distance _____

Measured distance _____

Other Evidence

Describe evidence of use and occupation such as roads, fences, clearings, timber cutting lines, plantations, etc.. Cite source of testimony if any. _____

At time of search:

1. Did you have the record description?
Yes _____ No _____

2. How was search area located?
Pacing, chaining, photos, maps, etc. _____

3. Mon hours spent in search _____

4. Do you think additional search might recover evidence? Yes _____ No _____

5. Signature _____

Perpetuation Record

Monument and accessories established. Include brief description of area. _____

set 2"x36" IP with 3 inch Brass cap, down 0.9 ft, Stamped

Red Pine	Aspen	8 Steel fence post
6.2 inch	6.4 inch	w/54-9 sign
S 39 E	S 31 1/2° W	west
46.80 ft	89.70 ft	2.0 ft

T147N R25W
1/4
S.11
S.14
1982
RLS 14677

All BT's have 60° spike in Base blaze

Certified corner restoration certificate prepared: Yes No _____

Filed in county records at Itasca Co Date 12-14-82 County Document No. 355062

Identified on aerial photo No. _____ Which is filed at _____

Index No. T21
(Alphabetical - Record)

LAND CORNER RECORD
(RECTANGULAR SURVEYS)

R9-7150-4 (Rev. 6/13/67)
GPO 802-127

T. 147 N. R. 25W 5TH Mer. N.F. Chippewa County Itasca State MN
Section Corner common to sections 11, 12, 13 and 14

EXISTING SURVEYS

Original Government Survey

Year surveyed 1875, B.C. BALDWIN
Original monument Post
(Wood post, stone, pile of stones, pipe, etc.)

Bearing Trees

Species _____
Diameter _____
Bearing _____
Distance _____

Subsequent Corner Restoration

Year surveyed 1984 By USFS
Where filed or recorded ITASCA COUNTY RECORDER
Monument USFS 2" PIPE WITH 3" BRASS
CAP.
(Original, concrete post, iron rod, etc.)

Bearing Trees, Reference Objects

Species _____
Diameter _____
Bearing _____
Distance _____

Original Evidence Found

Year of search _____ By _____
Monument found _____

Original Bearing Trees Found

Species _____
Diameter _____
Bearing _____
Distance _____

Evidence of Subsequent Corner Restoration Found

Year of search _____ By _____

Bearing Trees, Reference Objects

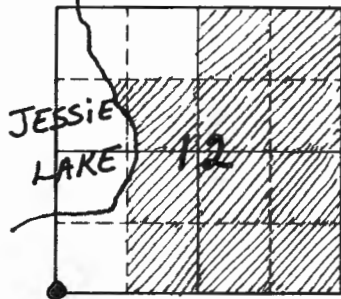

Sketch

○ Corner ▨ F.S. Land

Relation of Evidence to Record Features Along Section Lines

Section line to sections _____
 Object _____
 Record distance _____
 Measured distance _____

Other Evidence

Describe evidence of use and occupation such as roads, fences, clearings, timber cutting lines, plantations, etc.. Cite source of testimony if any. _____

At time of search:

1. Did you have the record description?

Yes No _____

2. How was search area located?

Pacing, chaining, photos, maps,
 etc. MAP + TIES

3. Man hours spent in search 1

4. Do you think additional search might
 recover evidence? Yes _____ No

JAN. 1989

5. Signature WCO

Perpetuation Record

Monument and accessories established. Include brief description of area. _____

10-12-88 PERSONNEL FROM KOVANEN + OSUFSEN
 SURVEYORS FIND USFS MONUMENT + BT'S AS PER
 1984 CERTIFICATE OF SURVEY - DOC. NO. 368789

Certified corner restoration certificate prepared: Yes No _____

Filed in county records of ITASCA Date 11/20/84 County Document No. 364445

Identified on aerial photo No. _____ Which is filed at _____

Index No. J-22
(Alphabetical - Numerical)

LAND CORNER RECORD
(RECTANGULAR SURVEYS)

R9-7150-4 (Rev. 6/13/67)
GPO 802-127

T. 147N R. 25W 5TH Mer. N.F. Chippewa County Itasca State MN
W 1/4 Corner common to sections _____, _____, 12 and 13

EXISTING SURVEYS

Original Government Survey

Year surveyed _____
Original monument _____
(Wood post, stone, pile of stones, pipe, etc.)

Bearing Trees

Species _____
Diameter _____
Bearing _____
Distance _____

Subsequent Corner Restoration

Year surveyed. 1984 By USFS
Where filed or recorded ITASCA COUNTY RECORDER
Monument USFS 2" x 24" BRASS CAP
(Original, concrete post, iron rod, etc.)

Bearing Trees, Reference Objects

Species _____
Diameter _____
Bearing _____
Distance _____

Original Evidence Found

Year of search _____ By _____
Monument found _____

Original Bearing Trees Found

Species _____
Diameter _____
Bearing _____
Distance _____

Evidence of Subsequent Corner Restoration Found

Year of search _____ By _____

Bearing Trees, Reference Objects

Species _____
Diameter _____
Bearing _____
Distance _____

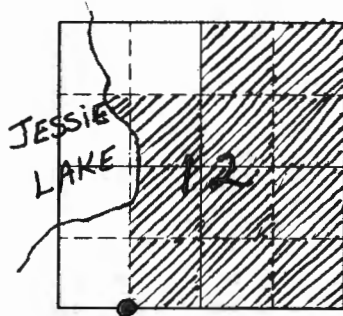

Sketch

○ Corner ▨ F.S. Land

Relation of Evidence to Record Features Along Section Lines

Section line to sections _____
 Object _____
 Record distance _____
 Measured distance _____

Other Evidence

Describe evidence of use and occupation such as roads, fences, clearings, timber cutting lines, plantations, etc.. Cite source of testimony if any. MONUMENT APPROX 1/2 of Highway No. 6 - RED line to NORTH

At time of search:

1. Did you have the record description?

Yes _____ No _____

2. How was search area located?

Pacing, chaining, photos, maps, etc. MAP & TIES

3. Man hours spent in search 1

4. Do you think additional search might recover evidence? Yes _____ No

JAN 1989

5. Signature WCO

Perpetuation Record

Monument and accessories established. Include brief description of area. 10-12-88 PERSONNEL FROM KOVANEN & OSVESEN SURVEYORS find USES MONUMENT & BT'S AS per 1984 Certificate of SURVEY Doc. No. 368789

Certified corner restoration certificate prepared: Yes _____ No

Filed in county records at ITASCA Date 1/20/89 County Document No. 368789

Identified on aerial photo No. _____ Which is filed at _____

Index No. J-23
(Alphabetical - Numerical)

LAND CORNER RECORD
(RECTANGULAR SURVEYS)

RD-7150-4 (Rev. 6/13/67)
 GPO 802-127

T. 147N R. 25W 1/4 5TH Mer. N.F. Chippewa County ITASCA State MN
 Corner common to sections 12 and 13

EXISTING SURVEYS

Original Government Survey

Year surveyed 1875 R. L. BALLWIN
 Original monument Post
(Wood post, stone, pile of stones, pipe, etc.)

Bearing Trees

Species N. PINE
 Diameter 20"
 Bearing S 48° W
 Distance 1.60'

Subsequent Corner Restoration

Year surveyed _____ By _____
 Where filed or recorded _____
 Monument _____
(Original, concrete post, iron rod, etc.)

Bearing Trees, Reference Objects

Species _____
 Diameter _____
 Bearing _____
 Distance _____

Original Evidence Found

Year of search _____ By _____
 Monument found _____

Original Bearing Trees Found

Species _____
 Diameter _____
 Bearing _____
 Distance _____

Evidence of Subsequent Corner Restoration Found

Year of search _____ By _____

Bearing Trees, Reference Objects

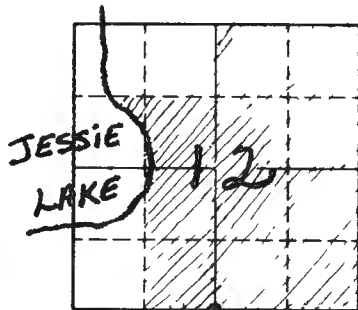

Sketch

○ Corner ▨ F.S. Land

Relation of Evidence to Record Features Along Section Lines

Section line to sections _____
 Object _____
 Record distance _____
 Measured distance _____

Other Evidence

Describe evidence of use and occupation such as roads, fences, clearings, timber cutting lines, plantations, etc.. Cite source of testimony if any. _____

CORNER POSITION APPROX. CENTERLINE STATE HWY # 1

SEARCH BY USFS PERSONNEL IN 1984 SURVEY FOR SECTION 1 FOUND NOTHING THEY SET W/16 BETWEEN SEC'S 12+13 BY SINGLE PROPORTION METHOD.

At time of search:

1. Did you have the record description?

Yes No _____

2. How was search area located?

Pacing, chaining, photos, maps, etc. TRAVERSE

3. Man hours spent in search 1

4. Do you think additional search might recover evidence? Yes _____ No

JAN. 1989

5. Signature WCO

Perpetuation Record

Monument and accessories established. Include brief description of area. _____

1-17-89 PERSONNEL FROM KOVANEN + OSUFSEN SURVEYORS SET P.K. NAIL FOR CORNER + THE FOLLOWING B.T.'S.

BALSAM 7" N12°W, 62.24 FEET

MAPLE 8" S51°W, 65.90 FEET

BIRCH 8" S53°E, 62.26 FEET

8' STEEL SIGN POST WITH 54-9 SIGN BEARS NORTH 28.95 FT.

Certified corner restoration certificate prepared: Yes No _____

Filed in county records at ITASCA Date _____ County Document No. _____

Identified on aerial photo No. _____ Which is filed at _____

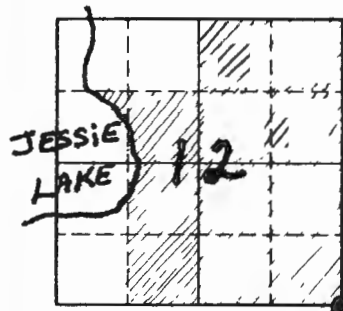

Sketch

○ Corner ▨ F.S. Land

Relation of Evidence to Record Features Along Section Lines

Section line to sections _____
 Object _____
 Record distance _____
 Measured distance _____

Other Evidence

Describe evidence of use and occupation such as roads, fences, clearings, timber cutting lines, plantations, etc.. Cite source of testimony if any. _____

CORNER IS AT APPROXIMATE P.I. OF OLD ROAD BED.

At time of search:

1. Did you have the record description?

Yes No _____

2. How was search area located?

Pacing, chaining, photos, maps,
 etc. MAP + TIES

3. Man hours spent in search 1

4. Do you think additional search might
 recover evidence? Yes _____ No

JAN 1989

5. Signature WCO

Perpetuation Record

Monument and accessories established. Include brief description of area. _____
9-26-88 PERSONNEL FROM KOVANEN + OSUFSEN SURVEYORS FIND
Co. MON. CAP GONE + PIPE BADLY BENT. Set spike from
TIES, 1-17-89 RETURNED TO CORNER + REPLACED SPIKE WITH USES
2" X 48" BRASS CAP MONUMENT.
N. PINE 14" N 43° W, 28.50 feet; J. PINE 14" S 75° W, 50.70'
N. PINE 5" N 10° W, 25.55 feet; ASPEN 6" N 26° E, 35.64'
8 feet long steel SIGN POST WITH 54-9 S. 9N BEARS
SOUTH 2.70 feet.

Certified corner restoration certificate prepared: Yes No _____

Filed in county records of HASCA Date _____ County Document No. _____

Identified on aerial photo No. _____ Which is filed at _____

T. 147N R. 25W 5th P. Mer. N.F. Chippewa County Itasca State Minnesota
 N 1/16 Corner common to sections 17 and *See corner Affidavit*

EXISTING SURVEYS

Original Government Survey	Original Evidence Found
Year surveyed _____ Original monument _____ <small>(Wood post, stone, pile of stones, pipe, etc.)</small>	Year of search _____ By _____ Monument found _____
<p style="text-align: center;">Bearing Trees</p> Species _____ Diameter _____ Bearing _____ Distance _____	<p style="text-align: center;">Original Bearing Trees Found</p> Species _____ Diameter _____ Bearing _____ Distance _____
Subsequent Corner Restoration	Evidence of Subsequent Corner Restoration Found
Year surveyed _____ By _____ Where filed or recorded _____ Monument _____ <small>(Original, concrete post, iron rod, etc.)</small> <p style="text-align: center;">Bearing Trees, Reference Objects</p> Species _____ Diameter _____ Bearing _____ Distance _____	Year of search _____ By _____ _____ _____ _____ _____ _____ _____ _____ _____ _____

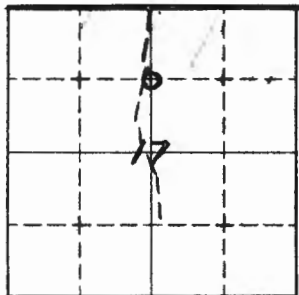

Sketch

○ Corner ▨ F.S. Land

Relation of Evidence to Record Features Along Section Lines

Section line to sections _____
Object _____
Record distance _____
Measured distance _____

Other Evidence

Describe evidence of use and occupation such as roads, fences, clearings, timber cutting lines, plantations, etc.. Cite source of testimony if any. An iron pipe and a F. S. location tag approximately 50 feet East of the N-S resort road. (9-14-64)

At time of search:

1. Did you have the record description?

Yes _____ No X

2. How was search area located?

Pacing, chaining, photos, maps, etc. Tag & local contact

3. Man hours spent in search 0

4. Do you think additional search might

recover evidence? Yes _____ No X

5. Signature G.R. Jahnke

Perpetuation Record

Monument and accessories established. Include brief description of area. _____

Certified corner restoration certificate prepared: Yes _____ No _____

Filed in county records at _____ Date _____ County Document No. _____

Identified on aerial photo No. _____ Which is filed at _____

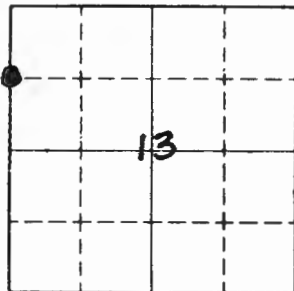

Sketch

○ Corner ▨ F.S. Land

Relation of Evidence to Record Features Along Section Lines

Section line to sections _____
 Object _____
 Record distance _____
 Measured distance _____

Other Evidence

Describe evidence of use and occupation such as roads, fences, clearings, timber cutting lines, plantations, etc.. Cite source of testimony if any. _____

At time of search:

1. Did you have the record description?

Yes _____ No _____

2. How was search area located?

Pacing, chaining, photos, maps,
 etc. _____

3. Man hours spent in search _____

4. Do you think additional search might
 recover evidence? Yes _____ No _____

5. Signature _____

Perpetuation Record

Monument and accessories established. Include brief description of area. _____

Certified corner restoration certificate prepared: Yes _____ No _____

Filed in county records at _____ Date _____ County Document No. _____

Identified on aerial photo No. _____ Which is filed at _____

Index No. K-22
(Alphabetical - Numerical)

LAND CORNER RECORD
(RECTANGULAR SURVEYS)

R9-7150-4 (Rev. 6/13/67)
GPO 802-127

T. 147N R. 25W STH Mer. N.F. Chippewa County ITASCA State MN
Corner common to sections 13 and _____

EXISTING SURVEYS

Original Government Survey

Year surveyed 9-10-1992 K&D INC.

Original monument 2" X 54" BRASS CAP USFS
(Wood post, stone, pile of stones, pipe, etc.)
M.N. OVER THE TOP OF 8" STEEL SIGN POST

Bearing Trees

Species	Diameter	Bearing	Distance
<u>SPRUCE CEDAR CEDAR</u>	<u>12" 8" 7"</u>	<u>N47°W N50°E N86°E</u>	<u>WEST</u>
<u>STEEL</u>	<u>SIGN POST</u>	<u>WEST</u>	<u>4.1 f</u>
			<u>North 4.0</u>

Original Evidence Found

Year of search _____ By _____

Monument found _____

Original Bearing Trees Found

Species	Diameter	Bearing	Distance
_____	_____	_____	_____
_____	_____	_____	_____
_____	_____	_____	_____

Subsequent Corner Restoration

Year surveyed _____ By _____

Where filed or recorded _____

Monument _____
(Original, concrete post, iron rod, etc.)

Evidence of Subsequent Corner Restoration Found

Year of search _____ By _____

Bearing Trees, Reference Objects

Species	Diameter	Bearing	Distance
_____	_____	_____	_____
_____	_____	_____	_____
_____	_____	_____	_____

Bearing Trees, Reference Objects

Species	Diameter	Bearing	Distance
_____	_____	_____	_____
_____	_____	_____	_____
_____	_____	_____	_____

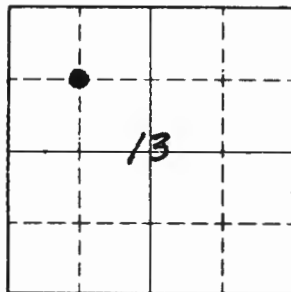

Sketch

○ Corner ▨ F.S. Land

Relation of Evidence to Record Features Along Section Lines

Section line to sections _____
 Object _____
 Record distance _____
 Measured distance _____

Other Evidence

Describe evidence of use and occupation such as roads, fences, clearings, timber cutting lines, plantations, etc.. Cite source of testimony if any. _____

At time of search:

1. Did you have the record description?

Yes _____ No _____

2. How was search area located?

Pacing, chaining, photos, maps, etc. _____

3. Man hours spent in search _____

4. Do you think additional search might recover evidence? Yes _____ No _____

5. Signature _____

Perpetuation Record

Monument and accessories established. Include brief description of area. _____

Certified corner restoration certificate prepared: Yes _____ No _____

Filed in county records at _____ Date _____ County Document No. _____

Identified on aerial photo No. _____ Which is filed at _____

Index No. L-20
(Alphabetical - Numerical)

Copy furnished

LAND CORNER RECORD
(RECTANGULAR SURVEYS)

RD-7150-4 (Rev. 6/13/67)
GPO 802-127

T. 147N R. 25W 5th Mer. N.F. Chippewa County Itasca State Minnesota
Center East 1/16 Corner common to sections 14 and 1/16 # 8

EXISTING SURVEYS

Original Government Survey

Year surveyed _____

Original monument _____
(Wood post, stone, pile of stones, pipe, etc.)

Bearing Trees

Species _____

Diameter _____

Bearing _____

Distance _____

Original Evidence Found

Year of search _____ By _____

Monument found _____

Original Bearing Trees Found

Species _____

Diameter _____

Bearing _____

Distance _____

Subsequent Corner Restoration

Year surveyed 1925 By LW Johnson Itasca Co.

Where filed or recorded Itasca Co. Courthouse

Monument Iron
(Original, concrete post, iron rod, etc.)

Evidence of Subsequent Corner Restoration Found

Year of search 1981 By P. Oleson

found no. Iron found old Fence corner

Dist from 1/16 to South OK

Dist from 1/4 to East OK

(Sectional Subdivision of Sec. 14)

Bearing Trees, Reference Objects

Species Spruce Balsam

Diameter 11" 11"

Bearing N45E S84E

Distance 39.0' 6.5'

Bearing Trees, Reference Objects

Spruce Rotten Balsam

Stump Stump

18" 575E

N54E 39.0' 6.5'

4/5 sec. 8 over growth

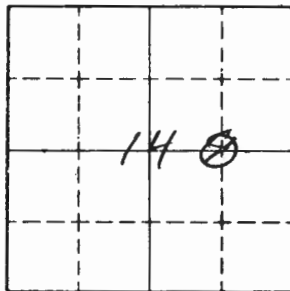

Sketch

○ Corner F.S. Land

Relation of Evidence to Record Features Along Section Lines

2-20

Section line to sections _____
 Object _____
 Record distance _____
 Measured distance _____

Other Evidence

Describe evidence of use and occupation such as roads, fences, clearings, timber cutting lines, plantations, etc.. Cite source of testimony if any. _____

At time of search:-

1. Did you have the record description?

Yes _____ No _____

2. How was search area located?

Pacing, chaining, photos, maps, etc. _____

3. Man hours spent in search _____

4. Do you think additional search might recover evidence? Yes _____ No _____

5. Signature _____

Perpetuation Record

Monument and accessories established. Include brief description of area.

To perpetuate this corner I set 92" x 5" iron with brass cap. marked from which bears

Ash Ash spruce

4" 5" 14"

N85W N6E S76E

16.32' 36.90 56.60

CE 1/16 S/4 BT

5/19/81
 Ronald Olson

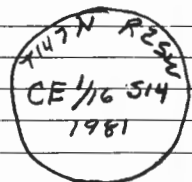

Certified corner restoration certificate prepared: Yes _____ No

Filed in county records of _____ Date _____ County Document No. _____

Identified on aerial photo No. _____ Which is filed at _____

Index No. L-21
(Alphabetical - Numerical)

Copy to merged
Book #1
Page #3
5th

LAND CORNER RECORD
(RECTANGULAR SURVEYS)

R9-7150-4 (Rev. 6/13/67)
GPO 802-127

S.O.

T. 147 N. R. 25 W Mer. N.F. Chippewa County Itasca State Minnesota
14 Corner common to sections 13 & 14 and _____

EXISTING SURVEYS

Original Government Survey

Year surveyed _____
Original monument _____
(Wood post, stone, pile of stones, pipe, etc.)

Bearing Trees

Species _____
Diameter _____
Bearing _____
Distance _____

Subsequent Corner Restoration

Year surveyed 1925 By Itasca County
LW Johnson
Where filed or recorded _____
Monument Iron
(Original, concrete post, iron rod, etc.)

Bearing Trees, Reference Objects

Species N. Pine Stump N. Pine Stp.
Diameter 18" 22"
Bearing S45E N32E
Distance 55.8' 40.9'

Original Evidence Found

Year of search _____ By _____
Monument found _____

Original Bearing Trees Found

Species _____
Diameter _____
Bearing _____
Distance _____

Evidence of Subsequent Corner Restoration Found

Year of search 1981 By R. Olosen
found 1" Iron in place

Bearing Trees, Reference Objects

N. Pine Stp. N. Pine Stp.
S35E N42E
55.8' 40.9'

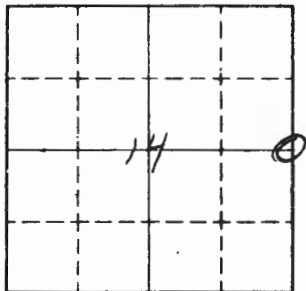

Sketch

○ Corner ▨ F.S. Land

Relation of Evidence to Record Features Along Section Lines

L-21

Section line to sections _____
 Object _____
 Record distance _____
 Measured distance _____

Other Evidence

Describe evidence of use and occupation such as roads, fences, clearings, timber cutting lines, plantations, etc.. Cite source of testimony if any. _____

At time of search:

1. Did you have the record description?

Yes _____ No _____

2. How was search area located?

Pacing, chaining, photos, maps, etc. _____

3. Man hours spent in search _____

4. Do you think additional search might recover evidence? Yes _____ No _____

5. Signature _____

Perpetuation Record

Monument and accessories established. Include brief description of area.

To perpetuate this corner I set a 2" x 2" Iron pipe w/ Brass Cap from which bears

J. Pine	J. Pine	J. Pine	ROW monument
6"	9"	9"	
N38E	S80E	S37E	East
59.60'	38.40'	81.87'	42.20'
1/4 S13	1/4 S13	1/4 S13	
BT	BT	BT	

marked

5/19/81
 Ronald O'Leary

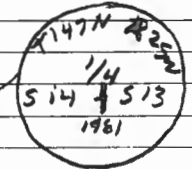

Certified corner restoration certificate prepared: Yes _____ No _____

Filed in county records at _____ Date _____ County Document No. _____

Identified on aerial photo No. _____ Which is filed at _____

Index No. 1-21
(Alphabetical - Numerical)

LAND CORNER RECORD
(RECTANGULAR SURVEYS)

RD-7150-4 (Rev. 6/13/67)
 GPO 502-127

T. 147 R. 25 Mer. N.F. Chippewa County Itasca State Mn.
E 1/4 Corner common to sections 14 and _____

EXISTING SURVEYS

Original Government Survey

Year surveyed 1875

Original monument wood post
(Wood post, stone, pile of stones, etc.)

Bearing Trees

Species	<u>J Pine</u>	<u>J Pine</u>
Diameter	<u>14"</u>	<u>12"</u>
Bearing	<u>N78W</u>	<u>S78E</u>
Distance	<u>12 lb.</u>	<u>65 lb.</u>

Original Evidence Found

Year of search 1932 By Info from NW DOT,
 Monument found on Duluth shawl corner 61.5
east of proposed centerline.

Original Bearing Trees Found

Species	_____	_____
Diameter	_____	_____
Bearing	_____	_____
Distance	_____	_____

Subsequent Corner Restoration

Year surveyed 1925 By Itasca Co.

Where filed or recorded _____

Monument set by last method
(Original, concrete post, iron rod, etc.)

Evidence of Subsequent Corner Restoration Found

Year of search 1981 By Olesen found
1925 pipe + 2T's - reset with
2" 20" brass cap monument - old
pipe set on N side.

Bearing Trees, Reference Objects

Species	_____	_____	_____
Diameter	_____	_____	_____
Bearing	_____	_____	_____
Distance	_____	_____	_____

Bearing Trees, Reference Objects

<u>J Pine</u>	<u>J Pine</u>	<u>J Pine</u>	<u>R/W Mon</u>
<u>6"</u>	<u>9"</u>	<u>9"</u>	
<u>N38E</u>	<u>S80E</u>	<u>S37E</u>	<u>E</u>
<u>59.60'</u>	<u>38.40'</u>	<u>81.87'</u>	<u>42.20'</u>

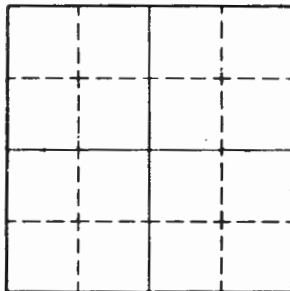

Sketch

○ Corner F.S. Land

Relation of Evidence to Record Features Along Section Lines

Section line to sections _____

Object _____

Record distance _____

Measured distance _____

Other Evidence

Describe evidence of use and occupation such as roads, fences, clearings, timber cutting lines, plantations, etc.. Cite source of testimony if any. _____

At time of search:

1. Did you have the record description?

Yes _____ No _____

2. How was search area located?

Pacing, chaining, photos, maps, etc. _____

3. Man hours spent in search _____

4. Do you think additional search might recover evidence? Yes _____ No _____

Perpetuation Record

Monument and accessories established. Include brief description of area. _____

CERTIFICATE FILED

Certified corner restoration certificate prepared: Yes _____ No Gary Stevenson

Filed in county records at Itasca Date 6/14/83 County Document No. 358210

5. Signature _____ Identified on aerial photo No. _____ Which is filed at _____

Index No. L-25
(Alphabetical - Numerical)

LAND CORNER RECORD
(RECTANGULAR SURVEYS)

RP-7150-4 (Rev. 6/13/67)
 GPO 802-127

T. 147 N R. 25 W 5th Mer. N.F. CHIDDEWA County ITASCA State MINN
STANDARD EAST 1/4 Corner common to sections 13 and _____

EXISTING SURVEYS

Original Government Survey

Year surveyed 1867 G.R. & G.E. STUART
 Original monument SET WOOD POST
(Wood post, stone, pile of stones, pipe, etc.)

Bearing Trees

Species TAMARAC FIR
 Diameter 6" 8"
 Bearing N45°W S12°W
 Distance 114 LKS 44 LKS
75.24 29.04

Subsequent Corner Restoration

Year surveyed 1913 By R.K. BLIGER
 Where filed or recorded Engd. Twp. File 26DSM
 Monument NOT MENTIONED
(Original, concrete post, iron rod, etc.)

Bearing Trees, Reference Objects

Species BIRCH FIR
 Diameter 5" 7"
 Bearing N68°W S32°W
 Distance 11 LKS 25 LKS.
7.26 16.5

Original Evidence Found

Year of search 1913 By R.K. BLIGER
 Monument found NOT MENTIONED

Original Bearing Trees Found

Species _____
 Diameter _____
 Bearing _____
 Distance _____

Evidence of Subsequent Corner Restoration Found

Year of search 1967 By E. Polovina IT. Co.
SURVEYORS OFFICE LOOSE LEAF NOTES
T59N-R27W, PAGE 59 STATES "SET CO. MON"
FROM WHICH

Bearing Trees, Reference Objects

ASH ASH
13" 6"
S38°W N26°W
4.50 16.82

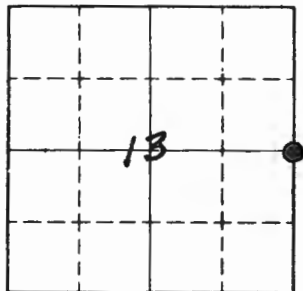

Sketch

○ Corner ▨ F.S. Land

Relation of Evidence to Record Features Along Section Lines

Section line to sections _____
 Object _____
 Record distance _____
 Measured distance _____

Other Evidence

Describe evidence of use and occupation such as roads, fences, clearings, timber cutting lines, plantations, etc.. Cite source of testimony if any. _____

At time of search:

1. Did you have the record description?

Yes No _____

2. How was search area located?

Pacing, chaining, photos, maps,
 etc. TRAVERSE

3. Mon hours spent in search 2

4. Do you think additional search might recover evidence? Yes _____ No

5. Signature WCD

Perpetuation Record

Monument and accessories established. Include brief description of area. 8-19-1992

B. RAMSTAD, TECH. K&D INC. FOUND IT. Co. MONUMENT
AND 2 - 1967 B.T.S

1967 ASH 8" (Sw in clump of 4) N21°W - 16.15 To SPK.

1967 ASH 15" S44°W - 5.20 to SPK.

NEW ASH 6" N79°E - 31.79

NEW Elm 6" S21°W - 19.10

Steel sign post North - 4.0

Certified corner restoration certificate prepared: Yes No _____

Filed in county records at ETASCA Date 12-8-92 County Document No. 436997

Identified on aerial photo No. _____ Which is filed at _____

Index No. M-13
(Alphabetical - Numerical)LAND CORNER RECORD
(RECTANGULAR SURVEYS)R9-7150-4 (Rev. 6/13/67)
GPO 802-127T. 147 N R. 25 W 5th Mer. N.F. Chippewa County Itasca State Minnesota
South 1/16 Corner common to sections 15, 16, and _____

EXISTING SURVEYS

Original Government Survey

Year surveyed _____

Original monument _____
(Wood post, stone, pile of stones, pipe, etc.)

Bearing Trees

Species _____

Diameter _____

Bearing _____

Distance _____

Subsequent Corner Restoration

Year surveyed _____ By _____

Where filed or recorded _____

Monument _____
(Original, duplicate post, iron rod, etc.)

Bearing Trees, Reference Objects

Species _____

Diameter _____

Bearing _____

Distance _____

Original Evidence Found

Year of search _____ By _____

Monument found _____

Original Bearing Trees Found

Species _____

Diameter _____

Bearing _____

Distance _____

Evidence of Subsequent Corner Restoration Found

Year of search _____ By _____

Bearing Trees, Reference Objects

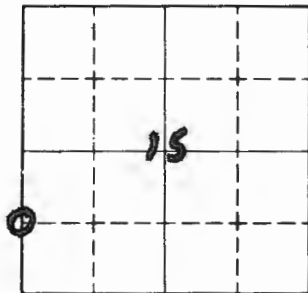

Sketch

○ Corner ▨ F.S. Land

Relation of Evidence to Record Features Along Section Lines

Section line to sections _____
 Object _____
 Record distance _____
 Measured distance _____

Other Evidence

Describe evidence of use and occupation such as roads, fences, clearings, timber cutting lines, plantations, etc.. Cite source of testimony if any. _____

At time of search:

1. Did you have the record description?

Yes _____ No _____

2. How was search area located?

Pacing, chaining, photos, maps,
 etc. _____

3. Man hours spent in search _____

4. Do you think additional search might
 recover evidence? Yes _____ No _____

5. Signature _____

Perpetuation Record

Monument and accessories established. Include brief description of area. _____

*I put up F.S. L.P. on the North side of a
 3" Cedar marking Approx 1/16 Cor
 painted blue line North & East of cor.*

4/15/76

Ronald Olson

Certified corner restoration certificate prepared: Yes _____ No _____

Filed in county records at _____ Date _____ County Document No. _____

Identified on aerial photo No. _____ Which is filed at _____

Index No. M-14
(Alphabetical - Numerical)LAND CORNER RECORD
(RECTANGULAR SURVEYS)R9-7150-4 (Rev. 6/13/67)
GPO 802-127T. 147 N. R. 25 W.
S.W. 1/4Mer. N.F. 5th Chippewa County Itasca State Minnesota
Corner common to sections 15 and _____

EXISTING SURVEYS

Original Government Survey

Year surveyed _____

Original monument _____
(Wood post, stone, pile of stones, pipe, etc.)

Bearing Trees

Species _____

Diameter _____

Bearing _____

Distance _____

Subsequent Corner Restoration

Year surveyed _____ By _____

Where filed or recorded _____

Monument _____
(Wrought, concrete post, iron rod, etc.)

Bearing Trees, Reference Objects

Species _____

Diameter _____

Bearing _____

Distance _____

Original Evidence Found

Year of search _____ By _____

Monument found _____

Original Bearing Trees Found

Species _____

Diameter _____

Bearing _____

Distance _____

Evidence of Subsequent Corner Restoration Found

Year of search _____ By _____

Bearing Trees, Reference Objects

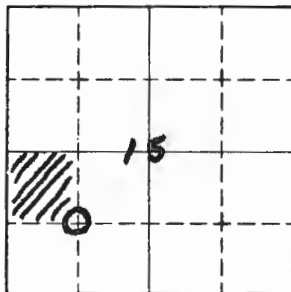

Sketch

○ Corner ▨ F.S. Land

Relation of Evidence to Record Features Along Section Lines

Section line to sections _____
 Object _____
 Record distance _____
 Measured distance _____

Other Evidence

Describe evidence of use and occupation such as roads, fences, clearings, timber cutting lines, plantations, etc.. Cite source of testimony if any. _____

At time of search:

1. Did you have the record description?
 Yes _____ No _____

2. How was search area located?
 Pacing, chaining, photos, maps,
 etc. _____

3. Man hours spent in search _____

4. Do you think additional search might
 recover evidence? Yes _____ No _____

5. Signature _____

Perpetuation Record

Monument and accessories established. Include brief description of area. _____

2 pot up F.S. L.P. on the west side of a 6" diameter marking approx. 1/16 Cor painted blue line west from Cor

4/15/75

Ronald Olson

Certified corner restoration certificate prepared: Yes _____ No _____

Filed in county records at _____ Date _____ County Document No. _____

Identified on aerial photo No. _____ Which is filed at _____

Index No. M-20
(Alphabetical - Numerical)

copy to marcell
Book #1
Page #11

LAND CORNER RECORD
(RECTANGULAR SURVEYS)

50
R9-7150-4 (Rev. 6/13/67)
GPO 802-127

T. 147N R. 25W Mer. N.F. Chippewa County Itasca State Minnesota
SE 1/4 Corner common to sections 14 and 1
1/4 #7

EXISTING SURVEYS

Original Government Survey

Original Evidence Found

Year surveyed _____
Original monument _____
(Wood post, stone, pile of stones, pipe, etc.)

Year of search _____ By _____
Monument found _____

Bearing Trees

Original Bearing Trees Found

Species _____
Diameter _____
Bearing _____
Distance _____

Species _____
Diameter _____
Bearing _____
Distance _____

Subsequent Corner Restoration

Evidence of Subsequent Corner Restoration Found

Year surveyed. 1925 By LW Johnson Itasca CO
Where filed or recorded _____
Monument Iron
(Original, concrete post, iron rod, etc.)

Year of search 1981 By R. Olesen
found 1" Iron 18" long in place

Bearing Trees, Reference Objects

Remains of
Sedar Stump

Bearing Trees, Reference Objects

Species Cedar Cedar _____
Diameter 8" 7" _____
Bearing S7E N16W _____
Distance 6.0' 11.6' _____

520E N10W _____
6.0' 11.6' _____
w/scrive

Relation of Evidence to Record Features Along Section Lines

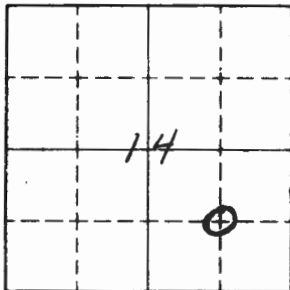

Sketch

○ Corner ▨ F.S. Land

Section line to sections _____
 Object _____
 Record distance _____
 Measured distance _____

Other Evidence

Describe evidence of use and occupation such as roads, fences, clearings, timber cutting lines, plantations, etc.. Cite source of testimony if any. _____

At time of search:

1. Did you have the record description?

Yes _____ No _____

2. How was search area located?

Pacing, chaining, photos, maps, etc. _____

3. Man hours spent in search _____

4. Do you think additional search might recover evidence? Yes _____ No _____

5. Signature _____

Perpetuation Record

Monument and accessories established. Include brief description of area.

To perpetuate this corner I set a 2" x 5" Iron pipe w/ Brass cap from which bears

Cedar	Cedar	Cedar
6"	8"	6"

NS6W	SG6W	SG6W
21.48'	20.72'	25.35'

SE 1/16	SE 1/16	SE 1/16
S14 BT	S14 BT	S14 BT

Marked

*5/19/81
Ronald Olson*

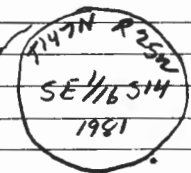

Certified corner restoration certificate prepared: Yes _____ No _____

Filed in county records at _____ Date _____ County Document No. _____

Identified on aerial photo No. _____ Which is filed at _____

Index No. M-21
(Alphabetical - Numerical)copy to Marshall Book # 5 Page # 5LAND CORNER RECORD
(RECTANGULAR SURVEYS)R9-7150-4 (Rev. 6/13/67)
GPO 502-127

5.01

T. 147 N R. 25 W
South 1/165th

Mer. N.F.

Chippewa

County

Itasca

State

Minnesota

Corner common to sections

13 & 14

EXISTING SURVEYS

Original Government Survey

Year surveyed _____

Original monument _____
(Wood post, stone, pile of stones, pipe, etc.)

Bearing Trees

Species _____

Diameter _____

Bearing _____

Distance _____

Original Evidence Found

Year of search _____ By _____

Monument found _____

Original Bearing Trees Found

Species _____

Diameter _____

Bearing _____

Distance _____

Subsequent Corner Restoration

Year surveyed 1925 By LW Johnson Itasca Co.

Where filed or recorded _____

Monument Iron
(Original, concrete post, iron rod, etc.)

Evidence of Subsequent Corner Restoration Found

Year of search 1981 By R. Olesenfound 1" x 2" Iron in place

Bearing Trees, Reference Objects

Species W. Pine Stump J. Pine StumpDiameter 16" 9"Bearing N 55 E S 10 WDistance 61.3' 52.8'

Bearing Trees, Reference Objects

Species W. Pine Stump J. Pine StumpBearing N 62 E S 18 WDistance 61.3' 52.8'w/scribe BT w/scribe BT

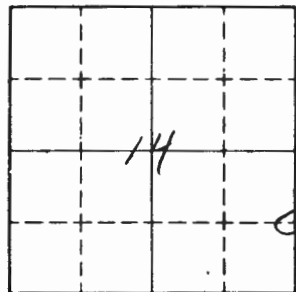

Sketch

○ Corner ▨ F.S. Land

Relation of Evidence to Record Features Along Section Lines

M-21

Section line to sections _____
 Object _____
 Record distance _____
 Measured distance _____

Other Evidence

Describe evidence of use and occupation such as roads, fences, clearings, timber cutting lines, plantations, etc.. Cite source of testimony if any. _____

At time of search:

1. Did you have the record description?

Yes _____ No _____

2. How was search area located?

Pacing, chaining, photos, maps, etc. _____

3. Man hours spent in search _____

4. Do you think additional search might recover evidence? Yes _____ No _____

5. Signature _____

Perpetuation Record

Monument and accessories established. Include brief description of area.

To perpetuate this Corner I set a 2" x 5" Iron pipe w. 1/4 Brass Cap from which bears

J. Pine	J. Pine	J. Pine	St Hwy ROW Monument
8"	11"	8"	P.O.T. 825+00 Alu. Cap.
S20W	S50E	N44E	S34E
30.19	21.43'	26.70'	25.80'
S 1/16 S14	S 1/16 S13	S 1/16 S13	
BT	BT	BT	

5/19/81
 Ronald Olson

Marked

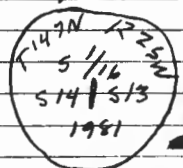

Certified corner restoration certificate prepared: Yes _____ No _____

Filed in county records at _____ Date _____ County Document No. _____

Identified on aerial photo No. _____ Which is filed at _____

Index No. M-22, 23
(Alphabetical - Numerical)

LAND CORNER RECORD
(RECTANGULAR SURVEYS)

RP-7150-4 (Rev. 6/13/67)
 GPO 802-127

T. 147 N R. 25W Sth Mer. N.F. Chippewa County ITASCA State MINN
C-E-SW 1/4 Corner common to section 13 and _____

EXISTING SURVEYS

Original Government Survey

Year surveyed 11-13-1992 K & D INC.
 Original monument 2" X 48" USFS BRASS CAP. MON.
(Wood post, stone, pile of stones, pipe, etc.)

Bearing Trees

Species	<u>BIRCH</u>	<u>TAMARAC</u>	<u>TAMARAC</u>	<u>Steel</u>
Diameter	<u>7"</u>	<u>7"</u>	<u>7"</u>	<u>Sign Posts</u>
Bearing	<u>N40°W</u>	<u>N52°E</u>	<u>S33°E</u>	<u>South-3.6</u>
Distance	<u>77.12</u>	<u>82.70</u>	<u>47.67</u>	<u>EAST-3.4</u>

Original Evidence Found

Year of search _____ By _____
 Monument found _____

Original Bearing Trees Found

Species	_____	_____	_____	_____
Diameter	_____	_____	_____	_____
Bearing	_____	_____	_____	_____
Distance	_____	_____	_____	_____

Subsequent Corner Restoration

Year surveyed _____ By _____
 Where filed or recorded _____
 Monument _____
(Original, concrete post, iron rod, etc.)

Evidence of Subsequent Corner Restoration Found

Year of search _____ By _____

Bearing Trees, Reference Objects

Species	_____	_____	_____	_____
Diameter	_____	_____	_____	_____
Bearing	_____	_____	_____	_____
Distance	_____	_____	_____	_____

Bearing Trees, Reference Objects

Species	_____	_____	_____	_____
Diameter	_____	_____	_____	_____
Bearing	_____	_____	_____	_____
Distance	_____	_____	_____	_____

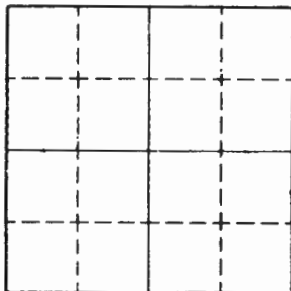

Sketch

Corner F.S. Land

Relation of Evidence to Record Features Along Section Lines

Section line to sections _____
 Object _____
 Record distance _____
 Measured distance _____

Other Evidence

Describe evidence of use and occupation such as roads, fences, clearings, timber cutting lines, plantations, etc.. Cite source of testimony if any. _____

At time of search:

1. Did you have the record description?

Yes _____ No _____

2. How was search area located?

Pacing, chaining, photos, maps, etc. _____

3. Man hours spent in search _____

4. Do you think additional search might recover evidence? Yes _____ No _____

5. Signature _____

Perpetuation Record

Monument and accessories established. Include brief description of area. _____

Certified corner restoration certificate prepared: Yes _____ No _____

Filed in county records at _____ Date _____ County Document No. _____

Identified on aerial photo No. _____ Which is filed at _____

Index No. M-23
(Alphabetical - Numerical)

LAND CORNER RECORD
(RECTANGULAR SURVEYS)

R9-7150-4 (Rev. 6/13/67)
 GPO 802-127

T. 147N R. 25W 5th Mer. N.F. Chippewa County ITASCA State MN
C.S. 1/6 Corner common to sections 13 and _____

EXISTING SURVEYS

Original Government Survey	Original Evidence Found
Year surveyed <u>11-13-1992 KEO INC.</u>	Year of search _____ By _____
Original monument <u>2" X 48" USFS BRASS CAP MON.</u> <small>(Wood post, stone, pile of stones, pipe, etc.)</small>	Monument found _____
Bearing Trees	Original Bearing Trees Found
Species <u>TAMARAC TAMARAC TAMARAC Steel</u>	Species _____
Diameter <u>2" 2" 8" Sign Posts</u>	Diameter _____
Bearing <u>N59°W North N75°E EAST-4.0</u>	Bearing _____
Distance <u>51.17 22.98 21.74 WEST-4.0</u>	Distance _____
Subsequent Corner Restoration	Evidence of Subsequent Corner Restoration Found
Year surveyed _____ By _____	Year of search _____ By _____
Where filed or recorded _____	_____
Monument _____ <small>(Original, concrete post, iron rod, etc.)</small>	_____
_____	_____
Bearing Trees, Reference Objects	Bearing Trees, Reference Objects
Species _____	_____
Diameter _____	_____
Bearing _____	_____
Distance _____	_____

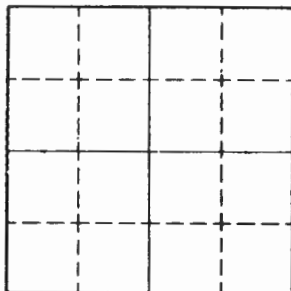

Sketch

Corner F.S. Land

Relation of Evidence to Record Features Along Section Lines

Section line to sections _____
Object _____
Record distance _____
Measured distance _____

Other Evidence

Describe evidence of use and occupation such as roads, fences, clearings, timber cutting lines, plantations, etc.. Cite source of testimony if any. _____

At time of search:

1. Did you have the record description?

Yes _____ No _____

2. How was search area located?

Pacing, chaining, photos, maps, etc. _____

3. Man hours spent in search _____

4. Do you think additional search might

recover evidence? Yes _____ No _____

5. Signature _____

Perpetuation Record

Monument and accessories established. Include brief description of area. _____

Certified corner restoration certificate prepared: Yes _____ No _____

Filed in county records at _____ Date _____ County Document No. _____

Identified on aerial photo No. _____ Which is filed at _____

Index No. M-25
(Alphabetical - Numerical)

LAND CORNER RECORD
(RECTANGULAR SURVEYS)

RR-7 150-4 (Rev. 6/13/67)
GPO 802-127

T. 147 N R. 25 W Sth Mer. N.F. CHIPPWA County ITASCA State MINN
STANDARD 5 1/16 Corner common to sections 13 and _____

EXISTING SURVEYS

Original Government Survey

Year surveyed 11-16-1992 K E O INC.
Original monument 2" X 60" USFS BRASS CAP MON.
(Wood post, stone, pile of stones, pipe, etc.)
IN SWAMP UP 0.50

Bearing Trees

Species	CEGAR	LEDAR	ASH	STEEL
Diameter	13"	10"	3"	SIGN POST
Bearing	N53°W	S89°W	S44°W	WEST-6.1
Distance	87.08	99.13	82.75	North-4.0

Original Evidence Found

Year of search _____ By _____
Monument found _____

Original Bearing Trees Found

Species	_____	_____	_____	_____
Diameter	_____	_____	_____	_____
Bearing	_____	_____	_____	_____
Distance	_____	_____	_____	_____

Subsequent Corner Restoration

Year surveyed _____ By _____
Where filed or recorded _____
Monument _____
(Original, concrete post, iron rod, etc.)

Evidence of Subsequent Corner Restoration Found

Year of search _____ By _____

Bearing Trees, Reference Objects

Species	_____	_____	_____	_____
Diameter	_____	_____	_____	_____
Bearing	_____	_____	_____	_____
Distance	_____	_____	_____	_____

Bearing Trees, Reference Objects

Species	_____	_____	_____	_____
Diameter	_____	_____	_____	_____
Bearing	_____	_____	_____	_____
Distance	_____	_____	_____	_____

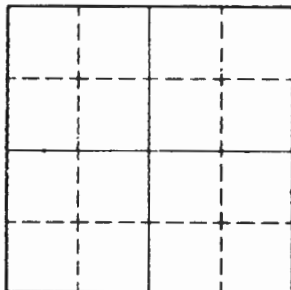

Sketch

○ Corner ▨ F.S. Land

Relation of Evidence to Record Features Along Section Lines

Section line to sections _____
 Object _____
 Record distance _____
 Measured distance _____

Other Evidence

Describe evidence of use and occupation such as roads, fences, clearings, timber cutting lines, plantations, etc.. Cite source of testimony if any. _____

At time of search:

1. Did you have the record description?

Yes _____ No _____

2. How was search area located?

Pacing, chaining, photos, maps, etc. _____

3. Man hours spent in search _____

4. Do you think additional search might recover evidence? Yes _____ No _____

5. Signature _____

Perpetuation Record

Monument and accessories established. Include brief description of area. _____

Certified corner restoration certificate prepared: Yes _____ No _____

Filed in county records of _____ Date _____ County Document No. _____

Identified on aerial photo No. _____ Which is filed at _____

Index No. N-21 (CARD 1)
(Alphabetical - Numerical)LAND CORNER RECORD
(RECTANGULAR SURVEYS)R9-7150-4 (Rev. 6/13/67)
GPO 802-127T. 147 N R. 25 W 5TH Mer. N.F. CHIPPEWA County ITASCA State MINN
SECTION Corner common to sections 13, 14, 23 and 24

EXISTING SURVEYS

Original Government Survey

Year surveyed 1875 B.C. BALDWIN
Original monument SET WOOD POST
(Wood post, stone, pile of stones, pipe, etc.)

Bearing Trees

Species	<u>J. Pine</u>	<u>J. Pine</u>	<u>J. Pine</u>	<u>J. Pine</u>
Diameter	<u>9"</u>	<u>6"</u>	<u>8"</u>	<u>7"</u>
Bearing	<u>S28°W</u>	<u>N01°W</u>	<u>S16°E</u>	<u>N37°E</u>
Distance	<u>42 LKS</u>	<u>23 LKS</u>	<u>33 LKS</u>	<u>24 LKS</u>
	<u>27.72</u>	<u>15.18</u>	<u>21.78</u>	<u>15.84</u>

Subsequent Corner Restoration

Year surveyed 1913 By R.K. BLILGER
Where filed or recorded IT. Co. Surveyors OFFICE
Monument Not mentioned - Survey of STATE Rd #2
(Original, concrete post, iron rod, etc.)
DEER RIVER - NOTHOM, Surveyors Record
Page 46

Bearing Trees, Reference Objects

Species	<u>T. POLE</u>	<u>T. POLE</u>		
Diameter				
Bearing	<u>S08°W</u>	<u>N21°W</u>		
Distance	<u>77.8</u>	<u>105.3</u>		

Original Evidence Found

Year of search 1913 By R.K. BLILGER
Monument found INDICATES TRACES OF GLO
CORNER FOUND

Original Bearing Trees Found

Species				
Diameter				
Bearing				
Distance				

Evidence of Subsequent Corner Restoration Found

Year of search 1919 By F.E. WILLIAMS - Survey
of Co. Rd. #58, Surveyors Record, Page 8
on file in ICDSM states "Found old BT'S"
and LISTS The Following

Bearing Trees, Reference Objects

Species	<u>J. Pine</u>	<u>J. Pine</u>	<u>J. Pine</u>	<u>J. Pine</u>
Diameter	<u>2"</u>	<u>1"</u>	<u>6"</u>	<u>3"</u>
Bearing	<u>S47°E</u>	<u>N40°W</u>	<u>N32°E</u>	<u>S02°W</u>
Distance	<u>77.5</u>	<u>45.9</u>	<u>108.6</u>	<u>42.4</u>

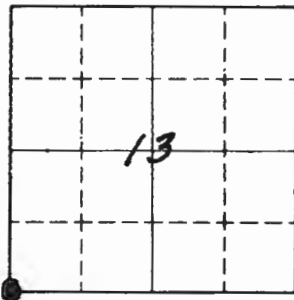

Sketch

○ Corner ▨ F.S. Land

Relation of Evidence to Record Features Along Section Lines

Section line to sections _____
 Object _____
 Record distance _____
 Measured distance _____

Other Evidence

Describe evidence of use and occupation such as roads, fences, clearings, timber cutting lines, plantations, etc.. Cite source of testimony if any. *JAN. 1925 J. Schwartz, Deputy Co. Surveyor, subdivision of Section 14 filed AS Instrument # 109760 in IT. Co. Recorders office indicates Gov't Corner in place and the following BT'S*
J. Pine 6" NB2°E - 17.8 Feet
J. Pine 6" WEST - 20.1 Feet
J. Pine 7" S40°E - 52.8 Feet
GOV'T STUMP SW

At time of search:

1. Did you have the record description?

Yes _____ No _____

2. How was search area located?

Pacing, chaining, photos, maps, etc. _____

3. Man hours spent in search _____

4. Do you think additional search might recover evidence? Yes _____ No _____

5. Signature _____

Perpetuation Record

Monument and accessories established. Include brief description of area. *Apr. 1934*
D.H. Wilson, Co. Surveyor, subdivision of Section 23
Filed AS Doc. No. 436321 in IT. Co. Recorders office
Shows Gov't Corner in place, and the following BT'S
J. Pine 6" NB2°E - 17.8 Feet
J. Pine 6" WEST - 20.1 Feet
J. Pine 7" S40°E - 52.8 Feet
J. Pine 5" S20°W - 26.8 Feet

Certified corner restoration certificate prepared: Yes _____ No _____

Filed in county records at _____ Date _____ County Document No. _____

Identified on aerial photo No. _____ Which is filed at _____

Index No. N-21 (CARD 2)
(Alphabetical - Numerical)LAND CORNER RECORD
(RECTANGULAR SURVEYS)

R9-7150-4 (Rev. 6/13/67)

GPO 802-127

T. 147N R. 25W 5th Mer. N.F. Chippewa County ITASCA State MN.
SECTION Corner common to sections 13, 14, 23 and 24

EXISTING SURVEYS

Original Government Survey

Year surveyed 2/11/1935 Donald Poole, CCC
Original monument Form 874-9 STATES FOUND
(wood post, stone, pile of stones, pipe, etc.)
WOOD STAKE IN PLACE, BELIEVES TO BE G.O.

Bearing Trees

Species	<u>J. Pine</u>	<u>J. Pine</u>	<u>J. Pine</u>	<u>J. Pine</u>
Diameter	<u>5"</u>	<u>6"</u>	<u>9"</u>	<u>6"</u>
Bearing	<u>S88°E</u>	<u>WEST</u>	<u>S35°E</u>	<u>S25°E</u>
Distance	<u>27 LKS</u>	<u>31 LKS</u>	<u>82 LKS</u>	<u>43 LKS</u>
	<u>17.8</u>	<u>20.5</u>	<u>54.1</u>	<u>28.4</u>

Subsequent Corner Restoration

Year surveyed 1955 By IT. Co.
Where filed or recorded ITASCA Co. Land Cor. Record
Monument
(Original, concrete post, iron rod, etc.)

Bearing Trees, Reference Objects

Species	<u>J. Pine</u>		
Diameter	<u>8"</u>		
Bearing	<u>S23°W</u>		
Distance	<u>26.5</u>		

Original Evidence Found

Year of search 4/23/1937 By CCC Form 874-9
Monument found STATES IRON MONUMENT FOUND
COR. SET BY Co. Surveyor D.H. Wilson 4-1934

Original Bearing Trees Found

Species	<u>J. Pine</u>	<u>J. Pine</u>	<u>J. Pine</u>	<u>J. Pine</u>
Diameter	<u>6"</u>	<u>6"</u>	<u>7"</u>	<u>5"</u>
Bearing	<u>N82°E</u>	<u>WEST</u>	<u>S40°E</u>	<u>S20°W</u>
Distance	<u>17.8</u>	<u>20.1</u>	<u>52.8</u>	<u>26.8</u>

Evidence of Subsequent Corner Restoration Found

Year of search 1973 By Greg Fordham ICOSM
LOOSE IRON NAIL NOTES 147-25 - SET 1/4" REBAR
OVER 1" SOLID SHAFT TO BRING CLOSER TO SURFACE

Bearing Trees, Reference Objects

Species	<u>J. Pine</u>	<u>J. Pine</u>	<u>J. Pine</u>
Diameter	<u>8"</u>	<u>12"</u>	<u>11"</u>
Bearing	<u>S82°W</u>	<u>S48°E</u>	<u>N31°E</u>
Distance	<u>26.04</u>	<u>29.39</u>	<u>45.46</u>

TAG

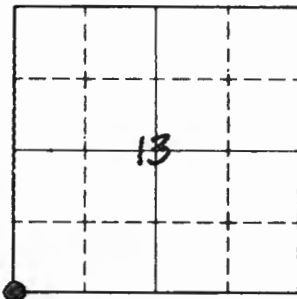

Sketch

○ Corner ▨ F.S. Land

Relation of Evidence to Record Features Along Section Lines

Section line to sections _____
 Object _____
 Record distance _____
 Measured distance _____

Other Evidence

Describe evidence of use and occupation such as roads, fences, clearings, timber cutting lines, plantations, etc.. Cite source of testimony if any. Aug. 1973 USDA Forest Service records on file in Cass Lake, MN. BK 1, T147N R25W, 5th PM, Page 2 indicates the following recovered T.P. SW Quad. 29.39 and states "ITASCA Co. Resurvey scribbling looks like this ERA.

At time of search:

1. Did you have the record description?

Yes _____ No _____

2. How was search area located?

Pacing, chaining, photos, maps, etc. _____

3. Man hours spent in search _____

4. Do you think additional search might recover evidence? Yes _____ No _____

5. Signature _____

Perpetuation Record

Monument and accessories established. Include brief description of area. May 1981 USFS records on file in Cass Lake, BK 1, T147N, R25W, Page 2 states "BT tags by G.L. Robertson and lists BT'S
 T. Pine N 38° E - 46.05 to Bd nail
 T. Pine S 25° E - 30.30 to Bd nail
 T. Pine S 41° E - 26.2 To Bd nail

Certified corner restoration certificate prepared: Yes _____ No _____

Filed in county records at _____ Date _____ County Document No. _____

Identified on aerial photo No. _____ Which is filed of _____

T. 147 N R. 25 W 5th Mer. N.F. MINNESOTA County ITASCA State MN
SECTION Corner common to sections 13 14 23 and 24

EXISTING SURVEYS

Original Government Survey

Year surveyed 1982 IT. Co. Land Corner RecordOriginal monument on file in ILDSM Lists
(Wood post, stone, pile of stones, pipe, etc.)The following witnesses

Bearing Trees

Species J. Pine J. Pine J. PineDiameter 8" 14" 11"Bearing S38°W S40°E S35°EDistance 26.35 30.36 45.98To nail To nail To nail

Subsequent Corner Restoration

Year surveyed 7-1986 By IT. Co.Where filed or recorded IT. Co. Land Cor. RecordMonument
(Original, concrete post, iron rod, etc.)

Bearing Trees, Reference Objects

Species P. Pole J. PineDiameter 15"Bearing N72°E N07°EDistance 56.61 51.15

Original Evidence Found

Year of search 7-17-1984 By K. Whitehorn and C. HoutariMonument found Down 0.5 Find 1/2" x 8" Iron Bolt & 200NAIL - Down 1.5 Find 1" Iron Rod & Charred wood

Original Bearing Trees Found

Species J. Pine J. Pine J. PineDiameter 8.0" 14.3" 11.2"Bearing S38°W S40°E N35°EDistance 26.35 30.36 45.78

Evidence of Subsequent Corner Restoration Found

Year of search 6-1992 By MN/DOT personnelon file in Bemidje's office - Found 4" rerodon centerline Co. Rd. 5 79.4 feet east ofcenterline and list the following BT's

Bearing Trees, Reference Objects

Species J. Pine J. Pine P. Pole J. PineDiameter 11" 12" N69°E 8"Bearing N35°E S48°E 57.10 S30°WDistance 46.05 30.36 26.35

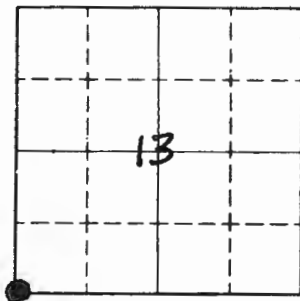

Sketch

○ Corner ▨ F.S. Land

Relation of Evidence to Record Features Along Section Lines

Section line to sections _____

Object _____

Record distance _____

Measured distance _____

Other Evidence

Describe evidence of use and occupation such as roads, fences, clearings, timber cutting lines, plantations, etc.. Cite source of testimony if any. OCT. 20, 1992 B. RAMSTAD TRGN, K&O INC. Found 1/4" rebar over 1" solid SHAFT - HE removed rebar and SET A 2" X 24" BRASS CAPPED IRON PIPE MONUMENT OVER 1" SOLID SHAFT. BTS shown BELOW

At time of search:

1. Did you have the record description?

Yes No _____

2. How was search area located?

Pacing, chaining, photos, maps, etc. TRAVERSE

3. Man hours spent in search 2

4. Do you think additional search might recover evidence? Yes _____ No

5. Signature WCD

Perpetuation Record

Monument and accessories established. Include brief description of area. 10-20-92

1982 J. Pine 11" (Stub) N35°E - 45.98 Feet

1986 P. Pole N72°E - 57.14 to MN/DOT CORNER ARIEL 8' DISC.

1982 J. Pine 12" (Stub) - S40°E - 30.30 Feet

1982 J. Pine 8" (Stub) - S38°W - 25.30 Feet

MN/DOT GPS STATION "HARJU" N85°W - 127.14

USFS CEDAR POST North 24.0 Feet

STEEL SIGN POST North - 33.00

Certified corner restoration certificate prepared: Yes No _____

Filed in county records at ITASCA Date 12-8-92 County Document No. 436996

Identified on aerial photo No. _____ Which is filed at _____

Index No. N-22
(Alphabetical - Numerical)LAND CORNER RECORD
(RECTANGULAR SURVEYS)R9-7150-4 (Rev. 6/13/67)
GPO 802-127T. 147 N R. 25 W 5th Mer. N.F. Chippewa County ITASCA State MN
W 1/16 Corner common to sections 13 and 24

EXISTING SURVEYS

Original Government Survey

Year surveyed Aug. 1973 - IT. Co. Surveyors office
Original monument 1 1/4" iron pipe
(Wood post, stone, pile of stones, pipe, etc.)

Bearing Trees

Species J. Pine P. Pole
Diameter 8"
Bearing S70°W S62°E
Distance 43.59 69.84
TA9

Subsequent Corner Restoration

Year surveyed 10-20-1992 By K&D INC.
Where filed or recorded ICD5M & USFS CASS LAKE
Monument ICMOOE Fd. Pipe & replace with
(Original, concrete post, iron rod, etc.)
2" x 24" USFS BRASS CAP MON. 10"
below surface of Road.

Bearing Trees, Reference Objects

Species W. Oak J. Pine J. Pine Steel
Diameter 12" 7" 6" Sign Post
Bearing N11°W S78°W S20°W North
Distance 94.32 68.73 52.76 33.0

Original Evidence Found

Year of search 9-1-1992 By K&D INC.
Monument found 1 1/4" iron pipe

Original Bearing Trees Found

Species 1973 J. Pine (Stub)
Diameter 9"
Bearing S78°W
Distance 43.6

Evidence of Subsequent Corner Restoration Found

Year of search _____ By _____

Bearing Trees, Reference Objects

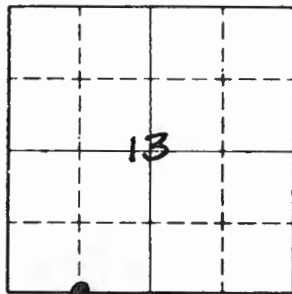

Sketch

○ Corner ▨ F.S. Land

Relation of Evidence to Record Features Along Section Lines

Section line to sections _____
 Object _____
 Record distance _____
 Measured distance _____

Other Evidence

Describe evidence of use and occupation such as roads, fences, clearings, timber cutting lines, plantations, etc.. Cite source of testimony if any. _____

At time of search:

1. Did you have the record description?

Yes _____ No _____

2. How was search area located?

Pacing, chaining, photos, maps, etc. _____

3. Man hours spent in search _____

4. Do you think additional search might recover evidence? Yes _____ No _____

5. Signature _____

Perpetuation Record

Monument and accessories established. Include brief description of area. _____

Certified corner restoration certificate prepared: Yes _____ No _____

Filed in county records at _____ Date _____ County Document No. _____

Identified on aerial photo No. _____ Which is filed at _____

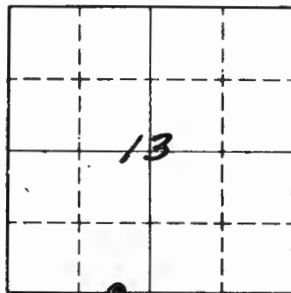

Sketch

○ Corner ▨ F.S. Land

Relation of Evidence to Record Features Along Section Lines

Section line to sections _____
 Object _____
 Record distance _____
 Measured distance _____

Other Evidence

Describe evidence of use and occupation such as roads, fences, clearings, timber cutting lines, plantations, etc.. Cite source of testimony if any. _____

At time of search:

1. Did you have the record description?

Yes _____ No _____

2. How was search area located?

Pacing, chaining, photos, maps, etc. _____

3. Man hours spent in search _____

4. Do you think additional search might

recover evidence? Yes _____ No _____

5. Signature _____

Perpetuation Record

Monument and accessories established. Include brief description of area. _____

Certified corner restoration certificate prepared: Yes _____ No _____

Filed in county records at _____ Date _____ County Document No. _____

Identified on aerial photo No. _____ Which is filed at _____

Index No. N-23
(Alphabetical - Numerical)

LAND CORNER RECORD
(RECTANGULAR SURVEYS)

R9-7150-4 (Rev. 6/15/67)
 GPO 802-127

T. 147 N R. 25 W Sth Mer. N.F. CHIPPENAW County ITASCA State MN
1/4 Corner common to sections 13 and 24

EXISTING SURVEYS

Original Government Survey
 Year surveyed 1875 B.C. BALDWIN
 Original monument SET Wood Post
(Wood post, stone, pile of stones, pipe, etc.)
Bearing Trees
 Species SPRUCE SPRUCE
 Diameter 8" 8"
 Bearing N03°W S29°W
 Distance 24 LKS 24 LKS
15.84 15.84

Original Evidence Found
 Year of search 1967 By E. Peloguin IT. Co.
 Monument found NONE
Original Bearing Trees Found
 Species _____
 Diameter _____
 Bearing _____
 Distance _____

Subsequent Corner Restoration
 Year surveyed 2-22-1967 By E. Peloguin IT. Co.
 Where filed or recorded Fieldnotes 147-25 IT. Co.
 Monument SURVEYORS OFFICE
(Original, concrete post, iron rod, etc.)
No record of corner being SET

Evidence of Subsequent Corner Restoration Found
 Year of search Aug. 1973 By Greg FORDHAM, I.T. Co.
SURVEYORS OFFICE SET 3/4" I.P. FOR COR.
2611.75 FEET EAST of the SW Cor. of Sec 13
Lists the 1967 witnesses and 2
new ones listed below

Bearing Trees, Reference Objects
 Species ASH Co. Mon.
 Diameter 5"
 Bearing South North
 Distance 28.75 16.0

Bearing Trees, Reference Objects
ASH ASH
12" 5"
S66°E S21°W
63.20 29.70

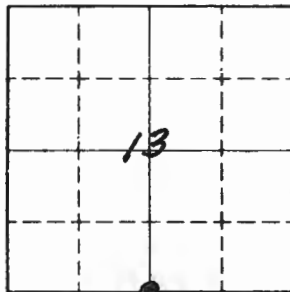

Sketch

○ Corner ▨ F.S. Land

Relation of Evidence to Record Features Along Section Lines

Section line to sections _____
 Object _____
 Record distance _____
 Measured distance _____

Other Evidence

Describe evidence of use and occupation such as roads, fences, clearings, timber cutting lines, plantations, etc.. Cite source of testimony if any. 5-25-1989 - Greg Robertson
ICDSM Fld. BK 1, p. 14 - Found 1" pipe bent over in road & replaced
with 1" x 18" iron pipe - 8' below road - He notes 1968 & 1973 and
adds 60d/washer to the following - ASH 8.5" S21°W - 80.85
ASH 8" S14°W 29.38 Also adds the following new BT's
ASH 8.5" S63°E - 54.19
ASH 8" N03°W - 102.06

At time of search:

1. Did you have the record description?

Yes No _____

2. How was search area located?

Pacing, chaining, photos, maps,
 etc. TRAVERSE

3. Man hours spent in search 2

4. Do you think additional search might
 recover evidence? Yes _____ No

5. Signature WB

Perpetuation Record

Monument and accessories established. Include brief description of area. 10-20-1992
B. Ramsstad, Tech. K&O Inc. Found 1" iron pipe - replaced
it with a 2" x 24" USFS BRASS CAP down. 10" in road.
1973 ASH 8" (dead) S62°E - 63.20, 1973 ASH 8" S09°W - 29.25
1973 ASH 10" S24°W - 30.19
1989 ASH 8" N07°W - 102.06, 1989 ASH 5" S60°E - 54.19
IT. Co. Man. North - 15.71
Steel Sign post North - 16.5

Certified corner restoration certificate prepared: Yes No _____

Filed in county records at ITASCA Date 12-8-92 County Document No. 437002

Identified on aerial photo No. _____ Which is filed at _____

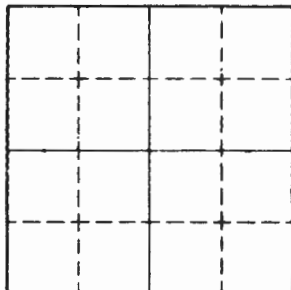

Sketch

Corner F.S. Land

Relation of Evidence to Record Features Along Section Lines

Section line to sections _____
 Object _____
 Record distance _____
 Measured distance _____

Other Evidence

Describe evidence of use and occupation such as roads, fences, clearings, timber cutting lines, plantations, etc.. Cite source of testimony if any. _____

At time of search:

1. Did you have the record description?

Yes _____ No _____

2. How was search area located?

Pacing, chaining, photos, maps, etc. _____

3. Man hours spent in search _____

4. Do you think additional search might

recover evidence? Yes _____ No _____

5. Signature _____

Perpetuation Record

Monument and accessories established. Include brief description of oreo. _____

Certified corner restoration certificate prepared: Yes _____ No _____

Filed in county records at _____ Date _____ County Document No. _____

Identified on aerial photo No. _____ Which is filed at _____

Index No. N-25
(Alphabetical - Numerical)

LAND CORNER RECORD
(RECTANGULAR SURVEYS)

R9-7160-4 (Rev. 6/13/67)
 GPO 802-127

T. 147 N R. 25 W 5th Mer. N.F. CHIPPENAW County ITASCA State MN
STANDARD SECTION Corner common to sections 24 and 13

EXISTING SURVEYS

Original Government Survey
 Year surveyed 1867 G.R. & G.C. STUNTE
 Original monument SET POST
(Wood post, stone, pile of stones, pipe, etc.)
 Bearing Trees
 Species BIRCH ELM
 Diameter 8" 12"
 Bearing N57°W S35°W
 Distance 25 LKS 50 LKS
16.50 33.00

Original Evidence Found
 Year of search 1875 By B.C. BALDWIN
 Monument found CALLS AN INTERSECTION OF HIS
RANDOM LINE 70 LINKS NORTH OF CORNER
 Original Bearing Trees Found
 Species _____
 Diameter _____
 Bearing _____
 Distance _____

Subsequent Corner Restoration
 Year surveyed 1913 By BLIKER
 Where filed or recorded BOG ROAD, TWP. FILE ICDSM
 Monument NOT MENTIONED
(Original, concrete post, iron rod, etc.)

Evidence of Subsequent Corner Restoration Found
 Year of search 1967 By E. PELLOUIN, ICDSM
LOUSE LEAF FIELD NOTES T29N, R27W, Pg. 59.
RUN LINE 13 & 24 AND USE THE NATURAL
CALLS FROM THE RIVER.
SET COUNTY MONUMENT

Bearing Trees, Reference Objects
 Species YELLOW PINE WHITE PINE
 Diameter 7" 12"
 Bearing N38°W S45°W
 Distance 25 LKS 38 LKS
16.50 25.08

Bearing Trees, Reference Objects
ASH ASH
 Diameter 5" 8"
 Bearing S14°W N89°W
6.83 5.15

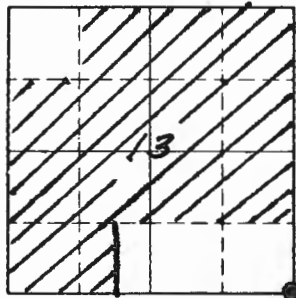

Sketch

○ Corner ▨ F.S. Land

Relation of Evidence to Record Features Along Section Lines

Section line to sections _____
 Object _____
 Record distance _____
 Measured distance _____

Other Evidence

Describe evidence of use and occupation such as roads, fences, clearings, timber cutting lines, plantations, etc. Cite source of testimony if any. 7/8/92 B. RAMSTAD
K&D INC. TRAVERSE to AREA FIND IT. Co. MONUMENT.
FOOD Co. MONUMENT DOES NOT FIT the
dimensions of the 1967 record.
ERROR MADE when position was MONUMENTED.

At time of search:

1. Did you have the record description?

Yes No _____

2. How was search area located?

Pacing, chaining, photos, maps,
 etc. TRAVERSE

3. Man hours spent in search 60

4. Do you think additional search might
 recover evidence? Yes _____ No

5. Signature WDD

Perpetuation Record

Monument and accessories established. Include brief description of area. 11/10/1992
B. RAMSTAD, TEEN. K&D INC. SET A 2" X 48" USFS
BRASS CAP MONUMENT AT 1967 record position
REMOVED IT. Co. MON. AND PLACED it on North
Side of new Mon. Flush with Ground.
1967 ASH 11" N76°W - 9.4 feet, 1967 ASH 7" S50°W - 8.82 Feet
NEW ASH 8" N17°W - 26.10, NEW ASH 6" N55°E - 26.75 Feet
NEW ASH 5" S71°E - 14.96 Feet.
STEEL SIGN POST WEST 4.0

Certified corner restoration certificate prepared: Yes No _____

Filed in county records at ITASCA Date 12-8-92 County Document No. 437001

Identified on aerial photo No. _____ Which is filed at _____

BOOK # 1, PAGE 66 LAND CORNER RECORD
(Rectangular)

1. T 147 R 25 No. V7 Cor. 14 Mer. 5th State MINN N. F. Chipp. Dist. Marcell X

2. Corner Status

3. Original Description X Vol. 1 Page 38 Where Recorded Dist. plat Book

4. Description of Corners:
Spruce 6" N 7° E 7 Lks
Spruce 6" S 42° E 10 Lks

7. Photo Identification
Photo No. _____
Ident. By: _____

5. Investigation Notes:
Found Iron pipe marking Cor. 1/2" dia.
Found remains of Spruce stump w/ scribe North 7 Links

8. Plane Coordinate Position Data
State _____ Zone _____
X _____
Y _____
Estab. By _____
Field Book No. _____
Where Filed _____

9. Evaluation
Authentic X
Needs Verif. _____ Monument _____
Re-estab. _____ Survey _____
Land Status _____

6. Signed O. Lind Title Dist Pan Date 9/20/61

PERPETUATION RECORD

10. Monument :

11. Accessories

Field Book _____ Page _____

12. Set By _____ Title _____

License _____ Agency _____ Date _____

13. Recorded By _____ (Agency) _____ Volume _____ Page _____

(Date) _____ (City) _____ (County) _____ (State) _____

14. Remarks:

Index No. V-15
(Alphabetical - Numerical)BOOK 1
Pg. 61LAND CORNER RECORD
(RECTANGULAR SURVEYS)R9-7150-4 (Rev. 6/13/67)
GPO 802-127T. 147 R. 25 S. 5 Mer. N.F. CHIPPEWA County ITASCA State MN.
QUARTER BET. Corner common to sections 27 and 34

EXISTING SURVEYS

Original Government Survey

Year surveyed 1875 B.C. BALDWIN
Original monument WOOD POST
(Wood post, stone, pile of stones, pipe, etc.)

Bearing Trees

Species TAM TAM.
Diameter 6 7
Bearing S78E N36W
Distance 23 LKS. 15 LKS.
15.18' 9.90'

Subsequent Corner Restoration

Year surveyed 1922 By ITASCA COUNTY
Where filed or recorded COURTHOUSE
Monument IRON PIPE
(Original, concrete post, iron rod, etc.)

Bearing Trees, Reference Objects

Species TAM. TAM. TAM. TAM.
Diameter 5 5 6 5
Bearing N18E S41W N55W S52E
Distance 23.2' 29.5' 41.2' 82.7'

Original Evidence Found

Year of search 1922 By ITASCA CO.
Monument found Ed. BOTH ORIG. BT'S.

Original Bearing Trees Found

Species TAM TAM.
Diameter 8 8
Bearing N61W S81E
Distance 10.0' 15.1'

Evidence of Subsequent Corner Restoration Found

Year of search 7-26-94 By RM-CK
Ed. 2" X 20" IRON PIPE + 3 POST POINTS
NO BT'S. COULD BE FOUND
RIBBON AREA - STOOD UP OLD POST 3"
30" HIGH ALONG SIDE IRON
W/TH MONUMENT WATER

Bearing Trees, Reference Objects

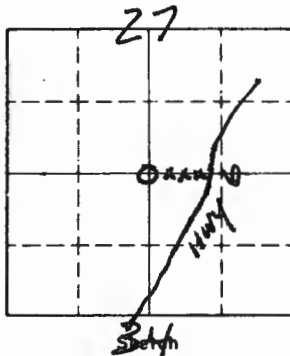

○ Corner ▣ F.S. Land

Relation of Evidence to Record Features Along Section Lines

Section line to sections _____
 Object _____
 Record distance _____
 Measured distance _____

Other Evidence

Describe evidence of use and occupation such as roads, fences, clearings, timber cutting lines, plantations, etc.. Cite source of testimony if any. _____

FENCE LINE RUNS WEST FROM 260' W TO 1000' W
 HWY 6 IS 160' WEST OF E 1/4

CORNER IN VERY WET TAM & CEDAR SWAMP
 WITH WIND FALLS & THICK BRUSH

WE HAVE GOOD B.T.'S. TO MARK IN AREA OF COR.
 CAN WALK ACROSS HWY FIELD NORTH OF FENCE LINE
 TO COR. LOCATION

Perpetuation Record

Monument and accessories established. Include brief description of area. _____

At time of search:

1. Did you have the record description?

Yes No _____

2. How was search area located?

Pacing chaining, photos maps,
 etc. _____

3. Man hours spent in search 1 HR.

4. Do you think additional search might
 recover evidence? Yes _____ No _____

5. Signature Carl Krause

Certified corner restoration certificate prepared: Yes _____ No _____

Filed in county records at _____ Date _____ County Document No. _____

Identified on aerial photo No. _____ Which is filed at _____

Index No. V-16
(Alphabetical - Numerical)

LAND CORNER RECORD
(RECTANGULAR SURVEYS)

R9-7150-4 (Rev. 6/13/67)
GPO 802-127

T. 147 R. 25 S. Mer. N.F. CHIPPEWA County ITASCA State MN.
EAST 1/16 Corner common to sections 27 and 34

EXISTING SURVEYS

Original Government Survey

Year surveyed _____
Original monument _____
(Wood post, stone, pile of stones, pipe, etc.)

Bearing Trees

Species _____
Diameter _____
Bearing _____
Distance _____

Original Evidence Found

Year of search _____ By _____
Monument found _____

Original Bearing Trees Found

Species _____
Diameter _____
Bearing _____
Distance _____

Subsequent Corner Restoration

Year surveyed 1922 By ITASCA COUNTY
Where filed or recorded COURTHOUSE (PLAT)
Monument IRON PIPE
(Original, concrete post, iron rod, etc.)

Bearing Trees, Reference Objects

Species POPLAR TAM.
Diameter 10 6
Bearing N19E S27E
Distance 31.6' 36.9'

Evidence of Subsequent Corner Restoration Found

Year of search 7/25/94 By RM+CK
FD. 1 1/4 X 18" IRON PIPE W/LATH ALONG
SIDE - IN NET LOWLAND ASH SWAMP
APPROX. 150' E OF HWY #6
NO EVIDENCE OF COUNTY B.T'S.
COULD BE FOUND - COULD HAVE BURN YEARS
A60

Bearing Trees, Reference Objects

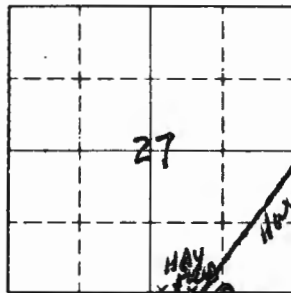

Sketch

O Corner F.S. Land

Relation of Evidence to Record Features Along Section Lines

Section line to sections _____
 Object _____
 Record distance _____
 Measured distance _____

Other Evidence

Describe evidence of use and occupation such as roads, fences, clearings, timber cutting lines, plantations, etc.. Cite source of testimony if any.

OPEN HAY FIELD ON WEST SIDE OF HWY 6
 WITH FENCE LINE AT SOUTH EDGE OF FIELD
 E 1/4 IS IN VERY WET LOWLAND SWAMP - APPROX.
 160' EAST OF HWY 6

7-26-94 RM-CK

MEASURED BETWEEN E 1/4 + 1/4 COR. - LINE RUN WEST
 DISTANCE WAS 1308' - DISTANCE FIT WITHIN 1.0'

At time of search:

1. Did you have the record description?

Yes No _____

2. How was search area located?

Pacing, air photos, maps
 etc. _____

3. Man hours spent in search _____

4. Do you think additional search might
 recover evidence? Yes _____ No _____

5. Signature Curt Krause

Perpetuation Record

Monument and accessories established. Include brief description of area.

APPEARS BOTH CORNERS ARE TRUE POSITIONS BY COUNTY
 NO TIES COULD BE FOUND AT EITHER COR. - THEY
 PROBABLY BURN UP YEARS AGO - FENCE LINE RUNS
 FROM 260' N TO 1000' W THEN THROUGH WET SWAMP
 WITH WINDFALLS + THICK BUSH

Certified corner restoration certificate prepared: Yes _____ No _____

Filed in county records at _____ Date _____ County Document No. _____

Identified on aerial photo No. _____ Which is filed at _____

Index No. W-8
(Alphabetical - Numerical)

LAND CORNER RECORD
(RECTANGULAR SURVEYS)

RS-5680-11 (5/12/61)

T. 147 N. R. 25 W. Sth. Mer. N.F. Chippewa County Ida State Minnesota
NE 1/16 Corner common to sections 32 and _____

EXISTING SURVEYS

Original Government Survey	Original Evidence Found
Year surveyed _____	Year of search _____ By _____
Original monument _____ <small>(Wood post, stone, pile of stones, pipe, etc.)</small>	Monument found _____
Bearing Trees	Original Bearing Trees Found
Species _____	Species _____
Diameter _____	Diameter _____
Bearing _____	Bearing _____
Distance _____	Distance _____
Subsequent Corner Restoration	Evidence of Subsequent Corner Restoration Found
Year surveyed _____ By _____	Year of search _____ By _____
Where filed or recorded _____	_____
Monument _____ <small>(Original, concrete post, iron rod, etc.)</small>	_____
_____	_____
_____	_____
Bearing Trees, Reference Objects	
Species _____	_____
Diameter _____	_____
Bearing _____	_____
Distance _____	_____

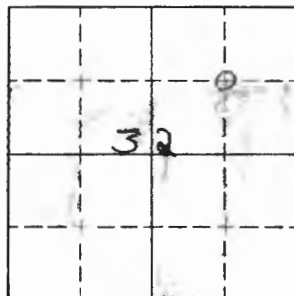

Sketch

○ Corner ▨ F.S. Land

Relation of Evidence to Record Features Along Section Lines

Section line to sections _____
 Object _____
 Record distance _____
 Measured distance _____

Other Evidence

Describe evidence of use and occupation such as roads, fences, clearings, timber cutting lines, plantations, etc.. Cite source of testimony if any. _____

At time of search:

1. Did you have the record description?

Yes _____ No ✓

2. How was search area located?

Pacing, chaining, photos, maps,
 etc. Photo-chaining

3. Man hours spent in search 1

4. Do you think additional search might
 recover evidence? Yes _____ No ✓

5. Signature J.P. Coyle

Perpetuation Record

Monument and accessories established. Include brief description of area.

Apr. Corner is a dead snag painted blue
A F.S. metal tag is set on a 10" Balsam tree and bears S 70° E - 19 links

A blazed and blue painted line runs east and west, (3-65)

Certified corner restoration certificate prepared: Yes _____ No _____

Filed in county records at _____ Date _____ County Document No. _____

Identified on aerial photo No. _____ Which is filed at _____

Index No. W-9
(Alphabetical - Numerical)

LAND CORNER RECORD
(RECTANGULAR SURVEYS)

R9-5680-11 (5/12/81)

T. 147N R. 25W 5th P Mer. N.F. Chippewa County Flasca State Minnesota
North 1/4 Corner common to sections 32 and 33

EXISTING SURVEYS

Original Government Survey

Year surveyed _____

Original monument _____
(Wood post, stone, pile of stones, pipe, etc.)

Bearing Trees

Species _____

Diameter _____

Bearing _____

Distance _____

Original Evidence Found

Year of search _____ By _____

Monument found _____

Original Bearing Trees Found

Species _____

Diameter _____

Bearing _____

Distance _____

Subsequent Corner Restoration

Year surveyed _____ By _____

Where filed or recorded _____

Monument _____
(Original, concrete post, iron rod, etc.)

Bearing Trees, Reference Objects

Species _____

Diameter _____

Bearing _____

Distance _____

Evidence of Subsequent Corner Restoration Found

Year of search _____ By _____

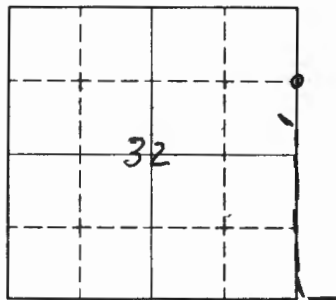

Sketch

○ Corner ▨ F.S. Land

Relation of Evidence to Record Features Along Section Lines

Section line to sections _____
 Object _____
 Record distance _____
 Measured distance _____

Other Evidence

Describe evidence of use and occupation such as roads, fences, clearings, timber cutting lines, plantations, etc.. Cite source of testimony if any. _____

Approx corner consists of a cedar post and a F.S. tag set S. 16° E, 12 1/2' on a cedar tree. A blue paint line runs west and south from the ~~established~~ corner.
approx.

2-17-65

At time of search:

1. Did you have the record description?

Yes _____ No X

2. How was search area located?

Pacing, chaining, photos, maps, etc. staff compass, and chaining.

3. Man hours spent in search _____

2 hours.

4. Do you think additional search might recover evidence? Yes _____ No X

Yes _____ No X

5. Signature J. D. [unclear]

Perpetuation Record

Monument and accessories established. Include brief description of area. _____

Certified corner restoration certificate prepared: Yes _____ No _____

Filed in county records at _____ Date _____ County Document No. _____

Identified on aerial photo No. _____ Which is filed at _____

Index No. W-13
(Alphabetical - Numerical)

LAND CORNER RECORD
(RECTANGULAR SURVEYS)

R9-7150-4 (Rev. 6/13/67)
GPO 802-127

T. 147 R. 25 S Mer. N.F. CHIPPEWA County ITASCA State MN.
APPROX. N 1/16 Corner common to sections _____, 33 and 34

EXISTING SURVEYS

Original Government Survey

Year surveyed _____
Original monument _____
(Wood post, stone, pile of stones, pipe, etc.)

Bearing Trees

Species _____
Diameter _____
Bearing _____
Distance _____

Subsequent Corner Restoration

Year surveyed _____ By _____
Where filed or recorded _____
Monument _____
(Original, concrete post, iron rod, etc.)

Bearing Trees, Reference Objects

Species _____
Diameter _____
Bearing _____
Distance _____

Original Evidence Found

Year of search _____ By _____
Monument found _____

Original Bearing Trees Found

Species _____
Diameter _____
Bearing _____
Distance _____

Evidence of Subsequent Corner Restoration Found

Year of search 7/27/94 By RM+CK
RAN LINE FROM GPS POINT IN SMALL OPENING
S32E - 600' TO EST. APPROX. N 1/16
WHICH WOULD BE FROM NW COR. SEC. 34
S3W - 1300' - PLACED FSLP ON
EAST SIDE OF 14" BALMIE STUB - 25' HIGH
Bearing Trees, Reference Objects OVER

Relation of Evidence to Record Features Along Section Lines

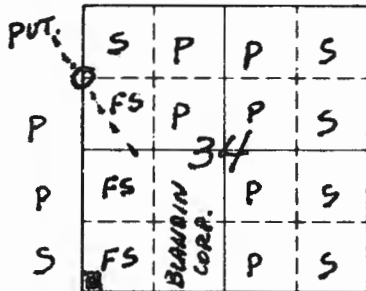

Sketch

○ Corner F.S. Land

Section line to sections _____
 Object _____
 Record distance _____
 Measured distance _____

Other Evidence

Describe evidence of use and occupation such as roads, fences, clearings, timber cutting lines, plantations, etc.. Cite source of testimony if any. _____

*ON WEST SIDE OF WOODS TRAIL NW-SE
 APPROX. COR WOULD FALL IN WEST RT OF ROAD
 TAG IS S 70 W - 10' FROM APPROX. COR.
 WILL RUN LINE EAST ON MONDAY*

At time of search:

1. Did you have the record description?

Yes _____ No _____

2. How was search area located?

Pacing, chaining, photos, maps,
 etc. _____

3. Man hours spent in search _____

4. Do you think additional search might

recover evidence? Yes _____ No _____

5. Signature *Curt Kramer*

Perpetuation Record

Monument and accessories established. Include brief description of area. _____

Certified corner restoration certificate prepared: Yes _____ No _____

Filed in county records at _____ Date _____ County Document No. _____

Identified on aerial-photo No. _____ Which is filed at _____

Relation of Evidence to Record Features Along Section Lines

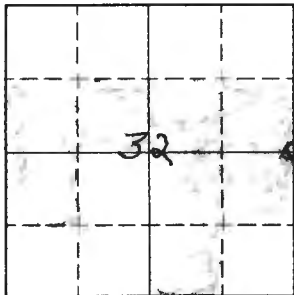

Sketch

○ Corner ▨ F.S. Land

Section line to sections _____

Object _____

Record distance _____

Measured distance _____

Other Evidence

Describe evidence of use and occupation such as roads, fences, clearings, timber cutting lines, plantations, etc.. Cite source of testimony if any.

Corner is located in edge of old road running north & south on section line

At time of search:

1. Did you have the record description?

Yes _____ No

2. How was search area located?

Pacing, chaining, photos, maps, etc. Photo-Chaining

3. Man hours spent in search 1

4. Do you think additional search might recover evidence? Yes _____ No

5. Signature F.R. Coyle

Perpetuation Record

Monument and accessories established. Include brief description of area.

Set 3" squared Aspen stake
F.S. metal tag set on 8" Aspen tree
and bears S20°W - 47 links from ^{NE} corner
(3-65)

Certified corner restoration certificate prepared: Yes _____ No _____

Filed in county records at _____ Date _____ County Document No. _____

Identified on aerial photo No. _____ Which is filed at _____

Index No. 4-8
(Alphabetical - Numerical)

LAND CORNER RECORD
(RECTANGULAR SURVEYS)

RS-5880-11 (5/12/61)

T. 142N R. 25W 5th Mer. N.F. Chippewa County Wisconsin State Wisconsin
SE 1/4 Corner common to sections 32 and

EXISTING SURVEYS

Original Government Survey

Year surveyed _____
Original monument _____
(Wood post, stone, pile of stones, pipe, etc.)

Bearing Trees

Species _____
Diameter _____
Bearing _____
Distance _____

Subsequent Corner Restoration

Year surveyed _____ By _____
Where filed or recorded _____
Monument _____
(Original, concrete post, iron rod, etc.)

Bearing Trees, Reference Objects

Species _____
Diameter _____
Bearing _____
Distance _____

Original Evidence Found

Year of search _____ By _____
Monument found _____

Original Bearing Trees Found

Species _____
Diameter _____
Bearing _____
Distance _____

Evidence of Subsequent Corner Restoration Found

Year of search _____ By _____

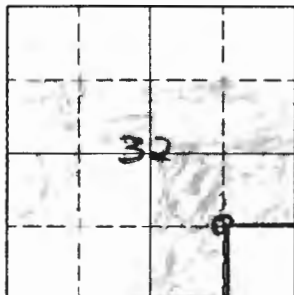

Sketch

○ Corner ▨ F.S. Land

Relation of Evidence to Record Features Along Section Lines

Section line to sections _____
Object _____
Record distance _____
Measured distance _____

Other Evidence

Describe evidence of use and occupation such as roads, fences, clearings, timber cutting lines, plantations, etc.. Cite source of testimony if any.

private land to S.E. of this ^{apx.} corner
has been cut

At time of search:

1. Did you have the record description?

Yes No _____

2. How was search area located?

Pacing, chaining, photos, maps,
etc. photo-chaining

3. Man hours spent in search 2

4. Do you think additional search might
recover evidence? Yes _____ No

5. Signature J. P. Coyle

Perpetuation Record

Monument and accessories established. Include brief description of area.

F.S. metal tag set on 10" cedar tree
which bears S 50° E 10 lks.

Blazed and blue pointed line
runs south and East from this
corner. (3-65)

Certified corner restoration certificate prepared: Yes _____ No _____

Filed in county records at _____ Date _____ County Document No. _____

Identified on aerial photo No. _____ Which is filed at _____

Index No. Y-9
(Alphabetical - Numerical)LAND CORNER RECORD
(RECTANGULAR SURVEYS)

RS-5680-11 (5/12/64)

T. 147 N R. 25 W Mer. N.F. 5th P Chippewa County Itasca State Minnesota
South 1/16 Corner common to sections 32 and 33

EXISTING SURVEYS

Original Government Survey

Year surveyed _____
Original monument _____
(Wood post, stone, pile of stones, pipe, etc.)

Bearing Trees

Species _____
Diameter _____
Bearing _____
Distance _____

Subsequent Corner Restoration

Year surveyed _____ By _____
Where filed or recorded _____
Monument _____
(Original, concrete post, iron rod, etc.)

Bearing Trees, Reference Objects

Species _____
Diameter _____
Bearing _____
Distance _____

Original Evidence Found

Year of search _____ By _____
Monument found _____

Original Bearing Trees Found

Species _____
Diameter _____
Bearing _____
Distance _____

Evidence of Subsequent Corner Restoration Found

Year of search _____ By _____

Relation of Evidence to Record Features Along Section Lines

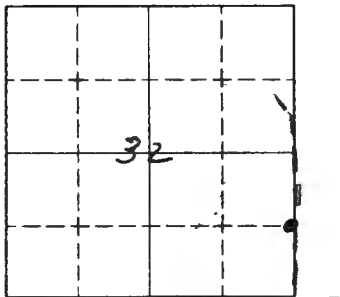

Sketch

○ Corner ▨ F.S. Land

Section line to sections _____
 Object _____
 Record distance _____
 Measured distance _____

Other Evidence

Describe evidence of use and occupation such as roads, fences, clearings, timber cutting lines, plantations, etc.. Cite source of testimony if any. _____

Approx. corner consists of a blue line running west. Area south of blue line has been cut over. No F.S. tag

2-17-65

At time of search:

1. Did you have the record description?

Yes _____ No

2. How was search area located?

Pacing, chaining, photos, maps, etc. *chaining*

3. Man hours spent in search _____

2 hours.

4. Do you think additional search might recover evidence? Yes _____ No

Perpetuation Record

Monument and accessories established. Include brief description of area. _____

Certified corner restoration certificate prepared: Yes _____ No _____

Filed in county records at _____ Date _____ County Document No. _____

5. Signature *J. D. Seema*

Identified on aerial photo No. _____ Which is filed at _____

Index No. 22
(Alphabetical - Numerical)

BOOK # 1
PAGE # 65
*S * P*

LAND CORNER RECORD
(RECTANGULAR SURVEYS)

NS-5880-11 (5/12/70)

T. 147 N R. 25 W Mer. N.F. Chippewa County Stasca State Minnesota
14 Corner common to sections 32 and 5

EXISTING SURVEYS

Original Government Survey

Year surveyed _____

Original monument _____
(Wood post, stone, pile of stones, pipe, etc.)

Bearing Trees

Species _____

Diameter _____

Bearing Need Field work.

Distance _____

Original Evidence Found

Year of search _____ By _____

Monument found _____

Original Bearing Trees Found

Species _____

Diameter _____

Bearing _____

Distance _____

Subsequent Corner Restoration

Year surveyed _____ By _____

Where filed or recorded _____

Monument _____
(Original, concrete post, iron rod, etc.)

Bearing Trees, Reference Objects

Species _____

Diameter _____

Bearing _____

Distance _____

Evidence of Subsequent Corner Restoration Found

Year of search _____ By _____

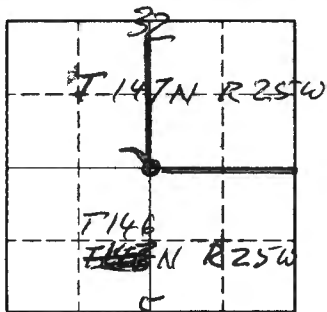

Sketch

○ Corner F.S. Land

Relation of Evidence to Record Features Along Section Lines

Section line to sections _____
 Object _____
 Record distance _____
 Measured distance _____

Other Evidence

Describe evidence of use and occupation such as roads, fences, clearings, timber cutting lines, plantations, etc.. Cite source of testimony if any. On old Birch snag
BT found south of fence and west of tag about
1/2 chain, found by Stejskal + Benson (9-3-64).

Corner monument should be set.

At time of search:

1. Did you have the record description?

Yes _____ No

2. How was search area located?

Pacing, chaining, photos, maps,
 etc. Location tag + map

3. Man hours spent in search 1

4. Do you think additional search might
 recover evidence? Yes No _____

5. Signature G. JAHNKE

Perpetuation Record

Monument and accessories established. Include brief description of area. _____

Certified corner restoration certificate prepared: Yes _____ No _____

Filed in county records at _____ Date _____ County Document No. _____

Identified on aerial photo No. _____ Which is filed at _____